

SuperH™ (SH) 32-Bit RISC MCU/MPU Series

**SH7750**

High-Performance RISC Engine

Programming Manual

**HITACHI**

ADE-602-156B

Rev. 3.0

09/20/99

Hitachi, Ltd.

## Cautions

1. Hitachi neither warrants nor grants licenses of any rights of Hitachi's or any third party's patent, copyright, trademark, or other intellectual property rights for information contained in this document. Hitachi bears no responsibility for problems that may arise with third party's rights, including intellectual property rights, in connection with use of the information contained in this document.
2. Products and product specifications may be subject to change without notice. Confirm that you have received the latest product standards or specifications before final design, purchase or use.
3. Hitachi makes every attempt to ensure that its products are of high quality and reliability. However, contact Hitachi's sales office before using the product in an application that demands especially high quality and reliability or where its failure or malfunction may directly threaten human life or cause risk of bodily injury, such as aerospace, aeronautics, nuclear power, combustion control, transportation, traffic, safety equipment or medical equipment for life support.
4. Design your application so that the product is used within the ranges guaranteed by Hitachi particularly for maximum rating, operating supply voltage range, heat radiation characteristics, installation conditions and other characteristics. Hitachi bears no responsibility for failure or damage when used beyond the guaranteed ranges. Even within the guaranteed ranges, consider normally foreseeable failure rates or failure modes in semiconductor devices and employ systemic measures such as fail-safes, so that the equipment incorporating Hitachi product does not cause bodily injury, fire or other consequential damage due to operation of the Hitachi product.
5. This product is not designed to be radiation resistant.
6. No one is permitted to reproduce or duplicate, in any form, the whole or part of this document without written approval from Hitachi.
7. Contact Hitachi's sales office for any questions regarding this document or Hitachi semiconductor products.

# Preface

The SH-4 (SH7750) has been developed as the top-end model in the SuperH™ RISC engine family, featuring a 128-bit graphic engine for multimedia applications and 360 MIPS performance.

The SH7750 CPU has a RISC type instruction set, and features upward-compatibility at the object code level with SH-1, SH-2, SH-3, and SH-3E microcomputers.

In addition to single- and double-precision floating-point operation capability, the on-chip FPU has a 128-bit graphic engine that enables 32-bit floating-point data to be processed 128 bits at a time. It also supports  $4 \times 4$  array operations and inner product operations, enabling a performance of 1.4 GFLOPS to be achieved.

A superscalar architecture is employed that enables simultaneous execution of two instructions (including FPU instructions), providing performance of up to twice that of conventional architectures at the same frequency.

SH7750 on-chip peripheral modules include oscillator circuits, an interrupt controller (INTC), direct memory access controller (DMAC), timer unit (TMU), real-time clock (RTC), serial communication interfaces (SCI, SCIF), and a user break controller (UBC), enabling a user system to be configured with a minimum of components.

An 8-kbyte instruction cache and 16-kbyte data cache are also provided, and the on-chip memory management unit (MMU) handles translation from the 4-Gbyte virtual address space to the physical address space. The bus state controller (BSC) supporting external memory access can handle a 64-bit synchronous DRAM 4-bank system and 64-bit data bus as well as ROM, SRAM, DRAM, synchronous DRAM, and PCMCIA.

This programming manual gives details of the SH7750 instructions. For hardware details, refer to the relevant hardware manual.

Related Manual:

SH7750 Hardware Manual (Document No. ADE-602-124B)

Please consult your Hitachi sales representative for information on development environment systems.

SuperH is a trademark of Hitachi, Ltd.

## Revisions and Additions in this Edition

Page	Item	Revisions (See Manual for Details)
2	1.1 SH7750 Features Table 1.1	167 MHz and 128 MHz operating frequency versions added
85	5.3.1 Exception Handling Flow	<ul style="list-style-type: none"> <li>• R15 added to description</li> <li>• Save general register 15 (SGR) added to description</li> <li>• RTE instruction description added</li> </ul>
88	5.5.1 Exception Flow	SGR added to description
91	5.5.3 Exception Requests and BL Bit	Description amended
92	5.6.1 Resets (1) Power-On Reset	Description added to Transition operations
97 to 110	5.6.2 General Exceptions (1) Data TLB Miss Exception to (14) FPU Exception	<ul style="list-style-type: none"> <li>• Description added to Transition operations</li> <li>• "SGR = R15;" added to each program</li> </ul>
111 to 113	5.6.3 Interrupts (1) NMI to (3) Peripheral Module Interrupts	<ul style="list-style-type: none"> <li>• Description added to Transition operations</li> <li>• "SGR = R15;" added to each program</li> </ul>
115	5.7 Usage Notes 2. If an exception or interrupt occurs when SR.BL = 1, a. Exception	Description amended for a. Exception

# Contents

Section 1 Overview.....	1
1.1 SH7750 Features.....	1
1.2 Block Diagram .....	8
Section 2 Programming Model.....	9
2.1 Data Formats .....	9
2.2 Register Configuration.....	10
2.2.1 Privileged Mode and Banks .....	10
2.2.2 General Registers .....	13
2.2.3 Floating-Point Registers .....	15
2.2.4 Control Registers.....	17
2.2.5 System Registers .....	18
2.3 Memory-Mapped Registers .....	20
2.4 Data Format in Registers.....	21
2.5 Data Formats in Memory .....	21
2.6 Processor States .....	22
2.7 Processor Modes.....	23
Section 3 Memory Management Unit (MMU) .....	25
3.1 Overview.....	25
3.1.1 Features .....	25
3.1.2 Role of the MMU .....	25
3.1.3 Register Configuration .....	28
3.1.4 Caution .....	28
3.2 Register Descriptions .....	29
3.3 Memory Space.....	32
3.3.1 Physical Memory Space .....	32
3.3.2 External Memory Space .....	35
3.3.3 Virtual Memory Space.....	36
3.3.4 On-Chip RAM Space .....	37
3.3.5 Address Translation.....	37
3.3.6 Single Virtual Memory Mode and Multiple Virtual Memory Mode .....	38
3.3.7 Address Space Identifier (ASID).....	38
3.4 TLB Functions.....	38
3.4.1 Unified TLB (UTLB) Configuration .....	38
3.4.2 Instruction TLB (ITLB) Configuration.....	42
3.4.3 Address Translation Method.....	42
3.5 MMU Functions .....	45
3.5.1 MMU Hardware Management .....	45

3.5.2	MMU Software Management .....	45
3.5.3	MMU Instruction (LDTLB).....	45
3.5.4	Hardware ITLB Miss Handling.....	46
3.5.5	Avoiding Synonym Problems .....	47
3.6	MMU Exceptions .....	48
3.6.1	Instruction TLB Multiple Hit Exception.....	48
3.6.2	Instruction TLB Miss Exception .....	49
3.6.3	Instruction TLB Protection Violation Exception.....	50
3.6.4	Data TLB Multiple Hit Exception.....	51
3.6.5	Data TLB Miss Exception .....	51
3.6.6	Data TLB Protection Violation Exception.....	52
3.6.7	Initial Page Write Exception.....	53
3.7	Memory-Mapped TLB Configuration.....	54
3.7.1	ITLB Address Array.....	55
3.7.2	ITLB Data Array 1 .....	56
3.7.3	ITLB Data Array 2 .....	57
3.7.4	UTLB Address Array .....	57
3.7.5	UTLB Data Array 1.....	59
3.7.6	UTLB Data Array 2.....	60
<b>Section 4 Caches .....</b>		<b>61</b>
4.1	Overview.....	61
4.1.1	Features .....	61
4.1.2	Register Configuration .....	62
4.2	Register Descriptions.....	62
4.3	Operand Cache (OC) .....	65
4.3.1	Configuration.....	65
4.3.2	Read Operation .....	66
4.3.3	Write Operation .....	67
4.3.4	Write-Back Buffer.....	69
4.3.5	Write-Through Buffer .....	69
4.3.6	RAM Mode.....	69
4.3.7	OC Index Mode.....	70
4.3.8	Coherency between Cache and External Memory.....	71
4.3.9	Prefetch Operation .....	71
4.4	Instruction Cache (IC).....	72
4.4.1	Configuration.....	72
4.4.2	Read Operation .....	73
4.4.3	IC Index Mode.....	74
4.5	Memory-Mapped Cache Configuration .....	74
4.5.1	IC Address Array .....	74
4.5.2	IC Data Array.....	75
4.5.3	OC Address Array.....	76

4.5.4	OC Data Array .....	78
4.6	Store Queues .....	79
4.6.1	SQ Configuration .....	79
4.6.2	SQ Writes .....	79
4.6.3	Transfer to External Memory .....	79
4.6.4	SQ Protection .....	81
Section 5 Exceptions .....		83
5.1	Overview .....	83
5.1.1	Features .....	83
5.1.2	Register Configuration .....	83
5.2	Register Descriptions .....	84
5.3	Exception Handling Functions .....	85
5.3.1	Exception Handling Flow .....	85
5.3.2	Exception Handling Vector Addresses .....	85
5.4	Exception Types and Priorities .....	86
5.5	Exception Flow .....	88
5.5.1	Exception Flow .....	88
5.5.2	Exception Source Acceptance .....	89
5.5.3	Exception Requests and BL Bit .....	91
5.5.4	Return from Exception Handling .....	91
5.6	Description of Exceptions .....	91
5.6.1	Resets .....	92
5.6.2	General Exceptions .....	97
5.6.3	Interrupts .....	111
5.6.4	Priority Order with Multiple Exceptions .....	114
5.7	Usage Notes .....	115
5.8	Restrictions .....	116
Section 6 Floating-Point Unit .....		117
6.1	Overview .....	117
6.2	Data Formats .....	117
6.2.1	Floating-Point Format .....	117
6.2.2	Non-Numbers (NaN) .....	119
6.2.3	Denormalized Numbers .....	120
6.3	Registers .....	121
6.3.1	Floating-Point Registers .....	121
6.3.2	Floating-Point Status/Control Register (FPSCR) .....	123
6.3.3	Floating-Point Communication Register (FPUL) .....	124
6.4	Rounding .....	124
6.5	Floating-Point Exceptions .....	125
6.6	Graphics Support Functions .....	126
6.6.1	Geometric Operation Instructions .....	126

6.6.2	Pair Single-Precision Data Transfer .....	128
<b>Section 7</b>	<b>Instruction Set.....</b>	<b>129</b>
7.1	Execution Environment.....	129
7.2	Addressing Modes .....	131
7.3	Instruction Set .....	135
<b>Section 8</b>	<b>Pipelining.....</b>	<b>149</b>
8.1	Pipelines.....	149
8.2	Parallel-Executability.....	156
8.3	Execution Cycles and Pipeline Stalling.....	160
<b>Section 9</b>	<b>Power-Down Modes.....</b>	<b>177</b>
9.1	Overview.....	177
9.1.1	Types of Power-Down Modes .....	177
9.1.2	Register Configuration .....	179
9.2	Register Descriptions.....	179
9.2.1	Standby Control Register (STBCR) .....	179
9.2.2	Peripheral Module Pin High Impedance Control .....	181
9.2.3	Peripheral Module Pin Pull-Up Control .....	182
9.2.4	Standby Control Register 2 (STBCR2) .....	182
9.3	Sleep Mode .....	183
9.3.1	Transition to Sleep Mode.....	183
9.3.2	Exit from Sleep Mode .....	183
9.4	Deep Sleep Mode.....	183
9.4.1	Transition to Deep Sleep Mode.....	183
9.4.2	Exit from Deep Sleep Mode .....	183
9.5	Standby Mode .....	184
9.5.1	Transition to Standby Mode.....	184
9.5.2	Exit from Standby Mode .....	185
9.5.3	Clock Pause Function.....	185
9.6	Module Standby Function .....	186
9.6.1	Transition to Module Standby Function .....	186
9.6.2	Exit from Module Standby Function .....	186
<b>Section 10</b>	<b>Instruction Descriptions .....</b>	<b>187</b>
10.1	ADD .....	200
10.2	ADDC .....	202
10.3	ADDV .....	203
10.4	AND .....	205
10.5	BF .....	207
10.6	BF/S .....	209
10.7	BRA .....	211



10.8	BRAF	BRANch Far	Branch Instruction	213
10.9	BSR	Branch to SubRoutine	Branch Instruction	214
10.10	BSRF	Branch to SubRoutine Far	Branch Instruction	216
10.11	BT	Branch if True	Branch Instruction	218
10.12	BT/S	Branch if True with delay Slot	Branch Instruction	220
10.13	CLRMAC	CleaR MAC register	System Control Instruction	222
10.14	CLRS	CleaR S bit	System Control Instruction	223
10.15	CLRT	CleaR T bit	System Control Instruction	224
10.16	CMP/cond	CoMPare conditionally	Arithmetic Instruction	225
10.17	DIV0S	DIVide (step 0) as Signed	Arithmetic Instruction	229
10.18	DIV0U	DIVide (step 0) as Unsigned	Arithmetic Instruction	230
10.19	DIV1	DIVide 1 step	Arithmetic Instruction	231
10.20	DMULS.L	Double-length MULtiplY as Signed	Arithmetic Instruction	236
10.21	DMULU.L	Double-length MULtiplY as Unsigned	Arithmetic Instruction	238
10.22	DT	Decrement and Test	Arithmetic Instruction	240
10.23	EXTS	EXTend as Signed	Arithmetic Instruction	241
10.24	EXTU	EXTend as Unsigned	Arithmetic Instruction	243
10.25	FABS	Floating-point ABSolute value	Floating-Point Instruction	244
10.26	FADD	Floating-point ADD	Floating-Point Instruction	245
10.27	FCMP	Floating-point CoMPare	Floating-Point Instruction	247
10.28	FCNVDS	Floating-point CoNVert Double to Single precision	Floating-Point Instruction	250
10.29	FCNVSD	Floating-point CoNVert Single to Double precision	Floating-Point Instruction	252
10.30	FDIV	Floating-point DIVide	Floating-Point Instruction	254
10.31	FIPR	Floating-point Inner PRoduct	Floating-Point Instruction	258
10.32	FLDIO	Floating-point LoaD Immediate 0.0	Floating-Point Instruction	260
10.33	FLDI1	Floating-point LoaD Immediate 1.0	Floating-Point Instruction	261
10.34	FLDS	Floating-point LoaD to System register	Floating-Point Instruction	262
10.35	FLOAT	Floating-point convert from integer	Floating-Point Instruction	263
10.36	FMAC	Floating-point Multiply and ACcumulate	Floating-Point Instruction	265
10.37	FMOV	Floating-point MOVE	Floating-Point Instruction	271
10.38	FMOV	Floating-point MOVE extension	Floating-Point Instruction	275
10.39	FMUL	Floating-point MULtiplY	Floating-Point Instruction	278
10.40	FNEG	Floating-point NEGate value	Floating-Point Instruction	280
10.41	FRCHG	FR-bit CHanGe	Floating-Point Instruction	281
10.42	FSCHG	Sz-bit CHanGe	Floating-Point Instruction	282
10.43	FSQRT	Floating-point SQUare RooT	Floating-Point Instruction	283
10.44	FSTS	Floating-point STore System register	Floating-Point Instruction	286
10.45	FSUB	Floating-point SUBtract	Floating-Point Instruction	287
10.46	FTRC	Floating-point TRuncate and Convert to integer	Floating-Point Instruction	289

10.47	FTRV	Floating-point TRansform Vector	Floating-Point Instruction	292
10.48	JMP	JuMP	Branch Instruction	295
10.49	JSR	Jump to SubRoutine	Branch Instruction	296
10.50	LDC	LoaD to Control register	System Control Instruction	298
10.51	LDS	LoaD to FPU System register	System Control Instruction	302
10.52	LDS	LoaD to System register	System Control Instruction	304
10.53	LDTLB	LoaD PTEH/PTEL/PTEA to TLB	System Control Instruction	306
10.54	MAC.L	Multiply and ACcumulate Long	Arithmetic Instruction	308
10.55	MAC.W	Multiply and ACcumulate Word	Arithmetic Instruction	312
10.56	MOV	MOVE data	Data Transfer Instruction	315
10.57	MOV	MOVE constant value	Data Transfer Instruction	320
10.58	MOV	MOVE global data	Data Transfer Instruction	323
10.59	MOV	MOVE structure data	Data Transfer Instruction	326
10.60	MOVA	MOVE effective Address	Data Transfer Instruction	329
10.61	MOVCA.L	MOVE with Cache block Allocation	Data Transfer Instruction	330
10.62	MOVT	MOVE T bit	Data Transfer Instruction	331
10.63	MUL.L	MULTiply Long	Arithmetic Instruction	332
10.64	MULS.W	MULTiply as Signed Word	Arithmetic Instruction	333
10.65	MULU.W	MULTiply as Unsigned Word	Arithmetic Instruction	334
10.66	NEG	NEGate	Arithmetic Instruction	335
10.67	NEGC	NEGate with Carry	Arithmetic Instruction	336
10.68	NOP	No OPERATION	System Control Instruction	337
10.69	NOT	NOT-logical complement	Logical Instruction	338
10.70	OCBI	Operand Cache Block Invalidate	Data Transfer Instruction	339
10.71	OCBP	Operand Cache Block Purge	Data Transfer Instruction	340
10.72	OCBWB	Operand Cache Block Write Back	Data Transfer Instruction	341
10.73	OR	OR logical	Logical Instruction	342
10.74	PREF	PREFetch data to cache	Data Transfer Instruction	344
10.75	ROTCL	ROTate with Carry Left	Shift Instruction	345
10.76	ROTCR	ROTate with Carry Right	Shift Instruction	346
10.77	ROTL	ROTate Left	Shift Instruction	347
10.78	ROTR	ROTate Right	Shift Instruction	348
10.79	RTE	ReTURN from Exception	System Control Instruction	349
10.80	RTS	ReTURN from Subroutine	Branch Instruction	351
10.81	SETS	SET S bit	System Control Instruction	353
10.82	SETT	SET T bit	System Control Instruction	354
10.83	SHAD	SHift Arithmetic Dynamically	Shift Instruction	355
10.84	SHAL	SHift Arithmetic Left	Shift Instruction	357
10.85	SHAR	SHift Arithmetic Right	Shift Instruction	358
10.86	SHLD	SHift Logical Dynamically	Shift Instruction	359
10.87	SHLL	SHift Logical Left	Shift Instruction	361
10.88	SHLLn	n bits SHift Logical Left	Shift Instruction	362
10.89	SHLR	SHift Logical Right	Shift Instruction	364

10.90	SHLRn	n bits SHift Logical Right	Shift Instruction	365
10.91	SLEEP	SLEEP	System Control Instruction	367
10.92	STC	STore Control register	System Control Instruction	368
10.93	STS	STore System register	System Control Instruction	373
10.94	STS	STore from FPU System register	System Control Instruction	375
10.95	SUB	SUBtract binary	Arithmetic Instruction	377
10.96	SUBC	SUBtract with Carry	Arithmetic Instruction	378
10.97	SUBV	SUBtract with (V flag) underflow check	Arithmetic Instruction	379
10.98	SWAP	SWAP register halves	Data Transfer Instruction	381
10.99	TAS	Test And Set	Logical Instruction	383
10.100	TRAPA	TRAP Always	System Control Instruction	385
10.101	TST	TeST logical	Logical Instruction	386
10.102	XOR	eXclusive OR logical	Logical Instruction	388
10.103	XTRCT	eXTRaCT	Data Transfer Instruction	390
Appendix A Address List				391
Appendix B Instruction Prefetch Side Effects				396

# Section 1 Overview

## 1.1 SH7750 Features

The SH7750 is a 32-bit RISC (reduced instruction set computer) microprocessor, featuring object code upward-compatibility with SH-1, SH-2, SH-3, and SH-3E microcomputers. It includes an 8-kbyte instruction cache, a 16-kbyte operand cache with a choice of copy-back or write-through mode, and an MMU (memory management unit) with a 64-entry fully-associative unified TLB (translation lookaside buffer).

The SH7750 has an on-chip bus state controller (BSC) that allows direct connection to DRAM and synchronous DRAM without external circuitry. Its 16-bit fixed-length instruction set enables program code size to be reduced by almost 50% compared with 32-bit instructions.

The features of the SH7750 are summarized in table 1.1.

**Table 1.1 SH7750 Features**

<b>Item</b>	<b>Features</b>
LSI	<ul style="list-style-type: none"><li>• Operating frequency: 200 MHz, 167 MHz, 128 MHz</li><li>• Performance:<ul style="list-style-type: none"><li>— 360 MIPS (200 MHz), 300 MIPS (167 MHz), 230 MIPS (128 MHz)</li><li>— 1.4 GFLOPS (200 MHz), 1.2 GFLOP(167 MHz), 0.9 GFLOPS (128 MHz)</li></ul></li><li>• Superscalar architecture: Parallel execution of two instructions</li><li>• Voltage: 1.95V (internal), 3.3 V (I/O): HD64417750BP200M 1.8V (internal), 3.3 V (I/O): HD6417750F167, HD6417750F167I 1.5V (internal), 3.3 V (I/O): HD6417750VF128</li><li>• Packages: 256-pin BGA, 208-pin QFP</li><li>• External buses<ul style="list-style-type: none"><li>— Separate 26-bit address and 64-bit data buses</li><li>— External bus frequency of 1/2, 1/3, 1/4, 1/6, or 1/8 times internal bus frequency</li></ul></li></ul>
CPU	<ul style="list-style-type: none"><li>• Original Hitachi SH architecture</li><li>• 32-bit internal data bus</li><li>• General register file:<ul style="list-style-type: none"><li>— Sixteen 32-bit general registers (and eight 32-bit shadow registers)</li><li>— Seven 32-bit control registers</li><li>— Four 32-bit system registers</li></ul></li><li>• RISC-type instruction set (upward-compatible with SH Series)<ul style="list-style-type: none"><li>— Fixed 16-bit instruction length for improved code efficiency</li><li>— Load-store architecture</li><li>— Delayed branch instructions</li><li>— Conditional execution</li><li>— C-based instruction set</li></ul></li><li>• Superscalar architecture (providing simultaneous execution of two instructions) including FPU</li><li>• Instruction execution time: Maximum 2 instructions/cycle</li><li>• Virtual address space: 4 Gbytes (448-Mbyte external memory space)</li><li>• Space identifier ASIDs: 8 bits, 256 virtual address spaces</li><li>• On-chip multiplier</li><li>• Five-stage pipeline</li></ul>

**Table 1.1 SH7750 Features (cont)**

<b>Item</b>	<b>Features</b>
FPU	<ul style="list-style-type: none"><li>• On-chip floating-point coprocessor</li><li>• Supports single-precision (32 bits) and double-precision (64 bits)</li><li>• Supports IEEE754-compliant data types and exceptions</li><li>• Two rounding modes: Round to Nearest and Round to Zero</li><li>• Handling of denormalized numbers: Truncation to zero or interrupt generation for compliance with IEEE754</li><li>• Floating-point registers: 32 bits × 16 words × 2 banks (single-precision × 16 words or double-precision × 8 words) × 2 banks</li><li>• 32-bit CPU-FPU floating-point communication register (FPUL)</li><li>• Supports FMAC (multiply-and-accumulate) instruction</li><li>• Supports FDIV (divide) and FSQRT (square root) instructions</li><li>• Supports FLDI0/FLDI1 (load constant 0/1) instructions</li><li>• Instruction execution times<ul style="list-style-type: none"><li>— Latency (FMAC/FADD/FSUB/FMUL): 3 cycles (single-precision), 8 cycles (double-precision)</li><li>— Pitch (FMAC/FADD/FSUB/FMUL): 1 cycle (single-precision), 6 cycles (double-precision)</li></ul></li><li>• Note: FMAC is supported for single-precision only.</li><li>• 3-D graphics instructions (single-precision only):<ul style="list-style-type: none"><li>— 4-dimensional vector conversion and matrix operations (FTRV): 4 cycles (pitch), 7 cycles (latency)</li><li>— 4-dimensional vector (FIPR) inner product: 1 cycle (pitch), 4 cycles (latency)</li></ul></li><li>• Five-stage pipeline</li></ul>

**Table 1.1 SH7750 Features (cont)**

<b>Item</b>	<b>Features</b>
Clock pulse generator (CPG)	<ul style="list-style-type: none"><li>• Choice of main clock: 1/2, 1, 3, or 6 times EXTAL</li><li>• Clock modes:<ul style="list-style-type: none"><li>— CPU frequency: 1, 1/2, 1/3, 1/4, 1/6, or 1/8 times main clock: maximum 200 MHz</li><li>— Bus frequency: 1/2, 1/3, 1/4, 1/6, or 1/8 times main clock: maximum 100 MHz</li><li>— Peripheral frequency: 1/2, 1/3, 1/4, 1/6, or 1/8 times main clock: maximum 50 MHz</li></ul></li><li>• Power-down modes<ul style="list-style-type: none"><li>— Sleep mode</li><li>— Standby mode</li><li>— Module standby function</li></ul></li><li>• Single-channel watchdog timer</li></ul>
Memory management unit (MMU)	<ul style="list-style-type: none"><li>• 4-Gbyte address space, 256 address space identifiers (8-bit ASIDs)</li><li>• Single virtual mode and multiple virtual memory mode</li><li>• Supports multiple page sizes: 1 kbyte, 4 kbytes, 64 kbytes, 1 Mbyte</li><li>• 4-entry fully-associative TLB for instructions</li><li>• 64-entry fully-associative TLB for instructions and operands</li><li>• Supports software-controlled replacement and random-counter replacement algorithm</li><li>• TLB contents can be accessed directly by address mapping</li></ul>

**Table 1.1 SH7750 Features (cont)**

<b>Item</b>	<b>Features</b>
Cache memory	<ul style="list-style-type: none"><li>• Instruction cache (IC)<ul style="list-style-type: none"><li>— 8 kbytes, direct mapping</li><li>— 256 entries, 32-byte block length</li><li>— Normal mode (8-kbyte cache)</li><li>— Index mode</li></ul></li><li>• Operand cache (OC)<ul style="list-style-type: none"><li>— 16 kbytes, direct mapping</li><li>— 512 entries, 32-byte block length</li><li>— Normal mode (16-kbyte cache)</li><li>— Index mode</li><li>— RAM mode (8-kbyte cache + 8-kbyte RAM)</li><li>— Choice of write method (copy-back or write-through)</li></ul></li><li>• Single-stage copy-back buffer, single-stage write-through buffer</li><li>• Cache memory contents can be accessed directly by address mapping (usable as on-chip memory)</li><li>• Store queue (32 bytes × 2 entries)</li></ul>
Interrupt controller (INTC)	<ul style="list-style-type: none"><li>• Five independent external interrupts (NMI, IRL3 to IRL0)</li><li>• 15-level signed external interrupts: IRL3 to IRL0</li><li>• On-chip peripheral module interrupts: Priority level can be set for each module</li></ul>
User break controller (UBC)	<ul style="list-style-type: none"><li>• Supports debugging by means of user break interrupts</li><li>• Two break channels</li><li>• Address, data value, access type, and data size can all be set as break conditions</li><li>• Supports sequential break function</li></ul>



**Table 1.1 SH7750 Features (cont)**

<b>Item</b>	<b>Features</b>
Bus state controller (BSC)	<ul style="list-style-type: none"><li>• Supports external memory access<ul style="list-style-type: none"><li>— 64/32/16/8-bit external data bus</li></ul></li><li>• External memory space divided into seven areas, each of up to 64 Mbytes, with the following parameters settable for each area:<ul style="list-style-type: none"><li>— Bus size (8, 16, 32, or 64 bits)</li><li>— Number of wait cycles (hardware wait function also supported)</li><li>— Direct connection of DRAM, synchronous DRAM, and burst ROM possible by setting space type</li><li>— Supports fast page mode and DRAM EDO</li><li>— Supports PCMCIA interface</li><li>— Chip select signals (<math>\overline{CS0}</math> to <math>\overline{CS6}</math>) output for relevant areas</li></ul></li><li>• DRAM/synchronous DRAM refresh functions<ul style="list-style-type: none"><li>— Programmable refresh interval</li><li>— Supports CAS-before-RAS refresh mode and self-refresh mode</li></ul></li><li>• DRAM/synchronous DRAM burst access function</li><li>• Big endian or little endian mode can be set</li></ul>
Direct memory access controller (DMAC)	<ul style="list-style-type: none"><li>• 4-channel physical address DMA controller</li><li>• Transfer data size: 8, 16, 32, or 64 bits, or 32 bytes</li><li>• Address modes:<ul style="list-style-type: none"><li>— 1-bus-cycle single address mode</li><li>— 2-bus-cycle dual address mode</li></ul></li><li>• Transfer requests: External, on-chip module, or auto-requests</li><li>• Bus modes: Cycle-steal or burst mode</li><li>• Supports on-demand data transfer</li></ul>
Timer unit (TMU)	<ul style="list-style-type: none"><li>• 3-channel auto-reload 32-bit timer</li><li>• Input capture function</li><li>• Choice of seven counter input clocks</li></ul>
Realtime clock (RTC)	<ul style="list-style-type: none"><li>• On-chip clock and calendar functions</li><li>• Built-in 32 kHz crystal oscillator with maximum 1/256 second resolution (cycle interrupts)</li></ul>

**Table 1.1 SH7750 Features (cont)**

<b>Item</b>	<b>Features</b>
Serial communication interface (SCI, SCIF)	<ul style="list-style-type: none"><li>• Two full-duplex communication channels (SCI, SCIF)</li><li>• Channel 1 (SCI):<ul style="list-style-type: none"><li>— Choice of asynchronous mode or synchronous mode</li><li>— Supports smart card interface</li></ul></li><li>• Channel 2 (SCIF):<ul style="list-style-type: none"><li>— Supports asynchronous mode</li><li>— Separate 16-byte FIFOs provided for transmitter and receiver</li></ul></li></ul>
Packages	<ul style="list-style-type: none"><li>• 256-pin BGA, 208-pin QFP</li></ul>

## 1.2 Block Diagram

Figure 1.1 shows an internal block diagram of the SH7750.

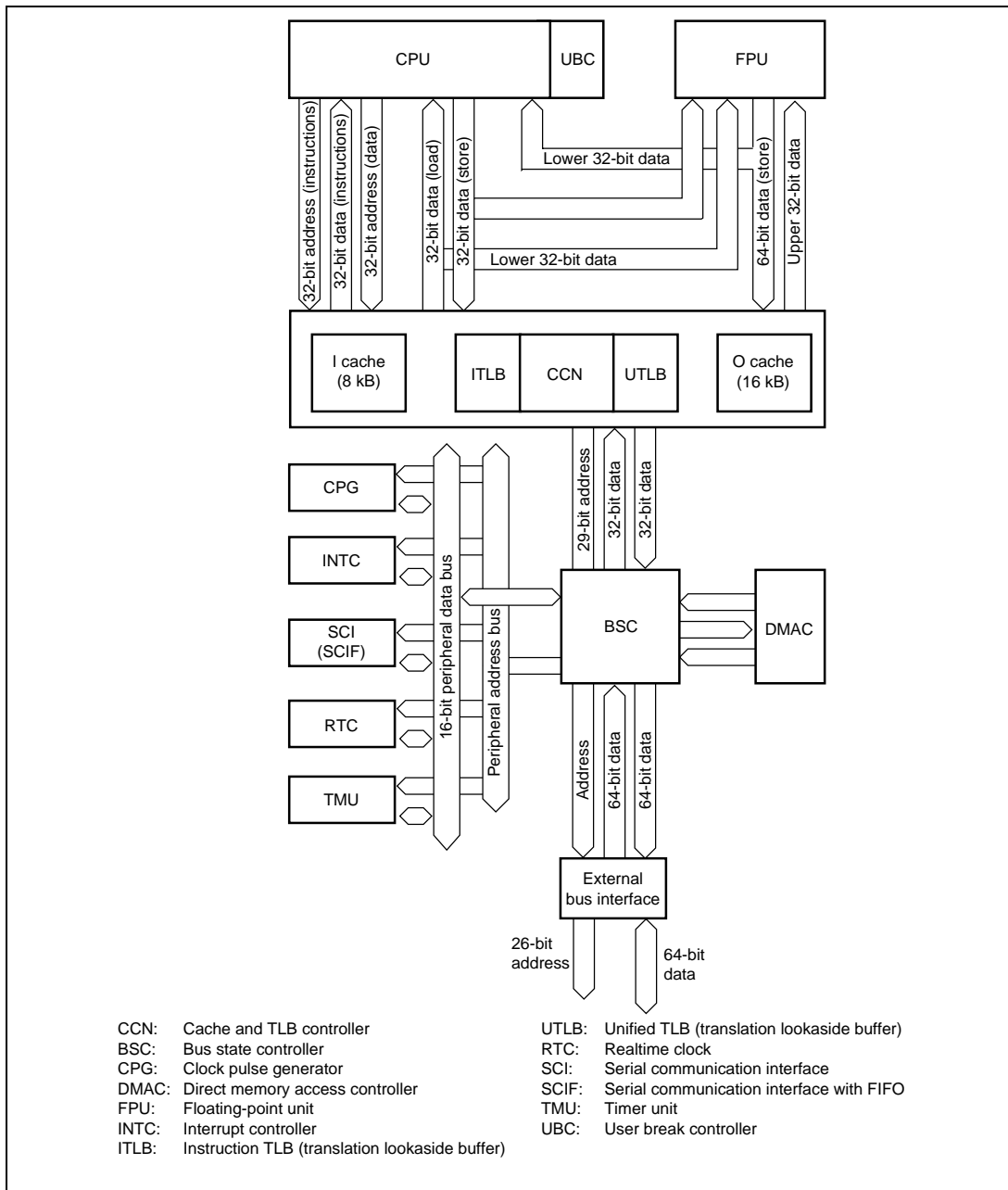

**Figure 1.1 Block Diagram of SH7750 Functions**

# Section 2 Programming Model

## 2.1 Data Formats

The data formats handled by the SH7750 are shown in figure 2.1.

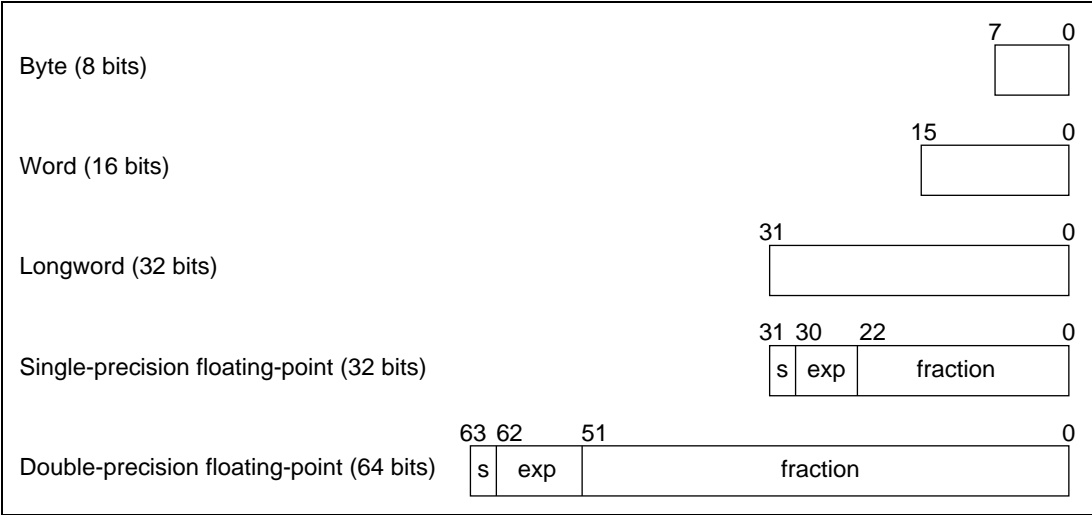

Figure 2.1 Data Formats

## 2.2 Register Configuration

### 2.2.1 Privileged Mode and Banks

**Processor Modes:** The SH7750 has two processor modes, user mode and privileged mode. The SH7750 normally operates in user mode, and switches to privileged mode when an exception occurs or an interrupt is accepted. There are four kinds of registers—general registers, system registers, control registers, and floating-point registers—and the registers that can be accessed differ in the two processor modes.

**General Registers:** There are 16 general registers, designated R0 to R15. General registers R0 to R7 are banked registers which are switched by a processor mode change.

In privileged mode, the register bank bit (RB) in the status register (SR) defines which banked register set is accessed as general registers, and which set is accessed only through the load control register (LDC) and store control register (STC) instructions.

When the RB bit is 1 (that is, when bank 1 is selected), the 16 registers comprising bank 1 general registers R0\_BANK1 to R7\_BANK1 and non-banked general registers R8 to R15 can be accessed as general registers R0 to R15. In this case, the eight registers comprising bank 0 general registers R0\_BANK0 to R7\_BANK0 are accessed by the LDC/STC instructions. When the RB bit is 0 (that is, when bank 0 is selected), the 16 registers comprising bank 0 general registers R0\_BANK0 to R7\_BANK0 and non-banked general registers R8 to R15 can be accessed as general registers R0 to R15. In this case, the eight registers comprising bank 1 general registers R0\_BANK1 to R7\_BANK1 are accessed by the LDC/STC instructions.

In user mode, the 16 registers comprising bank 0 general registers R0\_BANK0 to R7\_BANK0 and non-banked general registers R8 to R15 can be accessed as general registers R0 to R15. The eight registers comprising bank 1 general registers R0\_BANK1 to R7\_BANK1 cannot be accessed.

**Control Registers:** Control registers comprise the global base register (GBR) and status register (SR), which can be accessed in both processor modes, and the saved status register (SSR), saved program counter (SPC), vector base register (VBR), saved general register 15 (SGR), and debug base register (DBR), which can only be accessed in privileged mode. Some bits of the status register (such as the RB bit) can only be accessed in privileged mode.

**System Registers:** System registers comprise the multiply-and-accumulate registers (MACH/MACL), the procedure register (PR), the program counter (PC), the floating-point status/control register (FPSCR), and the floating-point communication register (FPUL). Access to these registers does not depend on the processor mode.

**Floating-Point Registers:** There are thirty-two floating-point registers, FR0–FR15 and XF0–XF15. FR0–FR15 and XF0–XF15 can be assigned to either of two banks (FPR0\_BANK0–FPR15\_BANK0 or FPR0\_BANK1–FPR15\_BANK1).

FR0–FR15 can be used as the eight registers DR0/2/4/6/8/10/12/14 (double-precision floating-point registers, or pair registers) or the four registers FV0/4/8/12 (register vectors), while XF0–XF15 can be used as the eight registers XD0/2/4/6/8/10/12/14 (register pairs) or register matrix XMTRX.

Register values after a reset are shown in table 2.1.

**Table 2.1 Initial Register Values**

Type	Registers	Initial Value*
General registers	R0_BANK0–R7_BANK0, R0_BANK1–R7_BANK1, R8–R15	Undefined
Control registers	SR	MD bit = 1, RB bit = 1, BL bit = 1, FD bit = 0, I3–I0 = 1111 (H'F), reserved bits = 0, others undefined
	GBR, SSR, SPC, SGR, DBR	Undefined
	VBR	H'00000000
System registers	MACH, MACL, PR, FPUL	Undefined
	PC	H'A0000000
	FPSCR	H'00040001
Floating-point registers	FR0–FR15, XF0–XF15	Undefined

Note: \* Initialized by a power-on reset and manual reset.

The register configuration in each processor is shown in figure 2.2.

Switching between user mode and privileged mode is controlled by the processor mode bit (MD) in the status register.

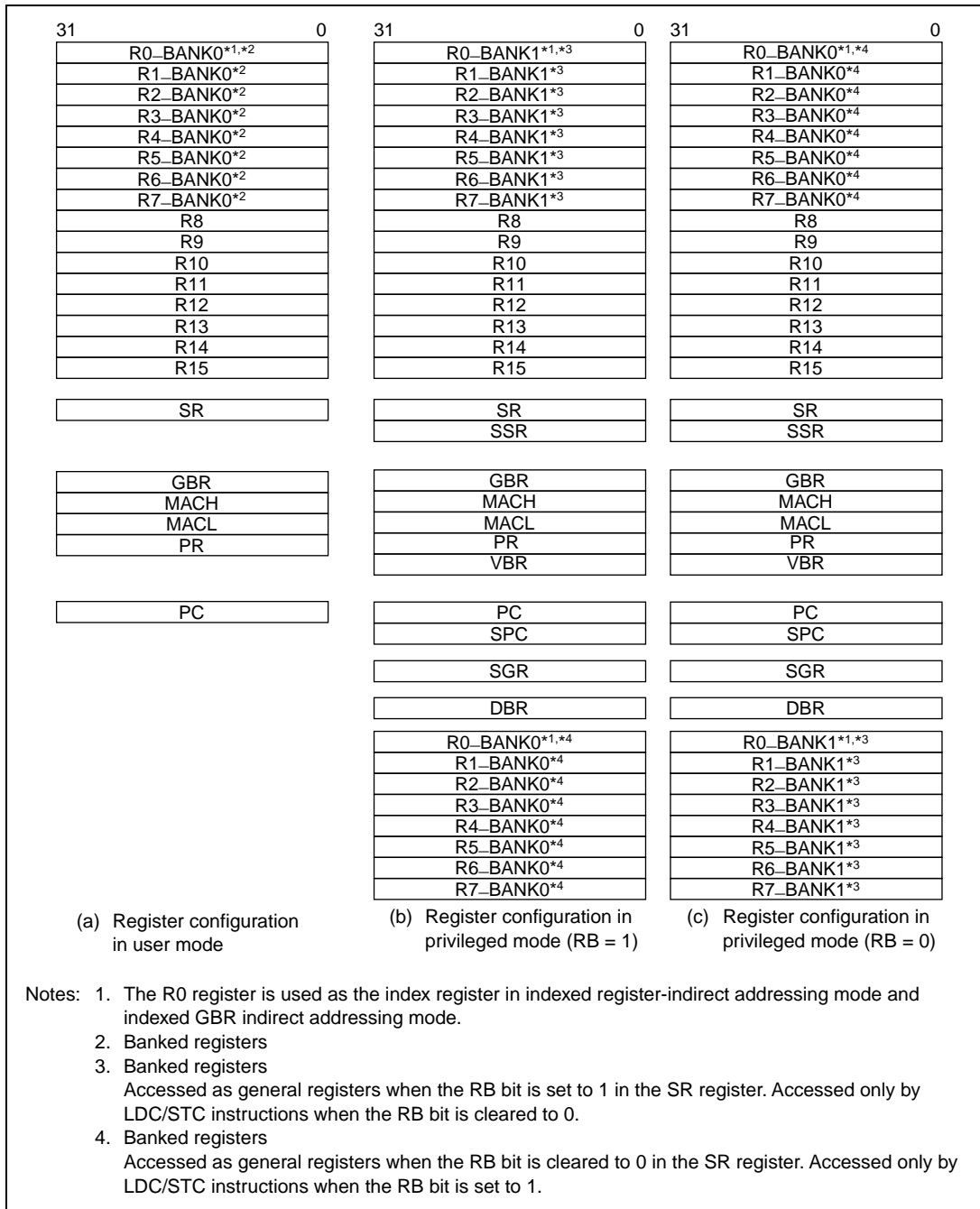

**Figure 2.2 CPU Register Configuration in Each Processor Mode**

### 2.2.2 General Registers

Figure 2.3 shows the relationship between the processor modes and general registers. The SH7750 has twenty-four 32-bit general registers (R0\_BANK0–R7\_BANK0, R0\_BANK1–R7\_BANK1, and R8–R15). However, only 16 of these can be accessed as general registers R0–R15 in one processor mode. The SH7750 has two processor modes, user mode and privileged mode, in which R0–R7 are assigned as shown below.

- R0\_BANK0–R7\_BANK0  
In user mode (SR.MD = 0), R0–R7 are always assigned to R0\_BANK0–R7\_BANK0.  
In privileged mode (SR.MD = 1), R0–R7 are assigned to R0\_BANK0–R7\_BANK0 only when SR.RB = 0.
- R0\_BANK1–R7\_BANK1  
In user mode, R0\_BANK1–R7\_BANK1 cannot be accessed.  
In privileged mode, R0–R7 are assigned to R0\_BANK1–R7\_BANK1 only when SR.RB = 1.



<u>SR.MD = 0 or (SR.MD = 1, SR.RB = 0)</u>		<u>(SR.MD = 1, SR.RB = 1)</u>
R0	R0_BANK0	R0_BANK0
R1	R1_BANK0	R1_BANK0
R2	R2_BANK0	R2_BANK0
R3	R3_BANK0	R3_BANK0
R4	R4_BANK0	R4_BANK0
R5	R5_BANK0	R5_BANK0
R6	R6_BANK0	R6_BANK0
R7	R7_BANK0	R7_BANK0
R0_BANK1	R0_BANK1	R0
R1_BANK1	R1_BANK1	R1
R2_BANK1	R2_BANK1	R2
R3_BANK1	R3_BANK1	R3
R4_BANK1	R4_BANK1	R4
R5_BANK1	R5_BANK1	R5
R6_BANK1	R6_BANK1	R6
R7_BANK1	R7_BANK1	R7
R8	R8	R8
R9	R9	R9
R10	R10	R10
R11	R11	R11
R12	R12	R12
R13	R13	R13
R14	R14	R14
R15	R15	R15

**Figure 2.3 General Registers**

**Programming Note:** As the user's R0–R7 are assigned to R0\_BANK0–R7\_BANK0, and after an exception or interrupt R0–R7 are assigned to R0\_BANK1–R7\_BANK1, it is not necessary for the interrupt handler to save and restore the user's R0–R7 (R0\_BANK0–R7\_BANK0).

After a reset, the values of R0\_BANK0–R7\_BANK0, R0\_BANK1–R7\_BANK1, and R8–R15 are undefined.

### 2.2.3 Floating-Point Registers

Figure 2.4 shows the floating-point registers. There are thirty-two 32-bit floating-point registers, divided into two banks (FPR0\_BANK0–FPR15\_BANK0 and FPR0\_BANK1–FPR15\_BANK1). These 32 registers are referenced as FR0–FR15, DR0/2/4/6/8/10/12/14, FV0/4/8/12, XF0–XF15, XD0/2/4/6/8/10/12/14, or XMTRX. The correspondence between FPRn\_BANKi and the reference name is determined by the FR bit in FPSCR (see figure 2.4).

- Floating-point registers, FPRn\_BANKi (32 registers)  
FPR0\_BANK0, FPR1\_BANK0, FPR2\_BANK0, FPR3\_BANK0, FPR4\_BANK0,  
FPR5\_BANK0, FPR6\_BANK0, FPR7\_BANK0, FPR8\_BANK0, FPR9\_BANK0,  
FPR10\_BANK0, FPR11\_BANK0, FPR12\_BANK0, FPR13\_BANK0, FPR14\_BANK0,  
FPR15\_BANK0  
  
FPR0\_BANK1, FPR1\_BANK1, FPR2\_BANK1, FPR3\_BANK1, FPR4\_BANK1,  
FPR5\_BANK1, FPR6\_BANK1, FPR7\_BANK1, FPR8\_BANK1, FPR9\_BANK1,  
FPR10\_BANK1, FPR11\_BANK1, FPR12\_BANK1, FPR13\_BANK1, FPR14\_BANK1,  
FPR15\_BANK1
- Single-precision floating-point registers, FRi (16 registers)  
When FPSCR.FR = 0, FR0–FR15 are assigned to FPR0\_BANK0–FPR15\_BANK0.  
When FPSCR.FR = 1, FR0–FR15 are assigned to FPR0\_BANK1–FPR15\_BANK1.
- Double-precision floating-point registers or single-precision floating-point register pairs, DRi (8 registers): A DR register comprises two FR registers.  
DR0 = {FR0, FR1}, DR2 = {FR2, FR3}, DR4 = {FR4, FR5}, DR6 = {FR6, FR7},  
DR8 = {FR8, FR9}, DR10 = {FR10, FR11}, DR12 = {FR12, FR13}, DR14 = {FR14, FR15}
- Single-precision floating-point vector registers, FVi (4 registers): An FV register comprises four FR registers  
FV0 = {FR0, FR1, FR2, FR3}, FV4 = {FR4, FR5, FR6, FR7},  
FV8 = {FR8, FR9, FR10, FR11}, FV12 = {FR12, FR13, FR14, FR15}
- Single-precision floating-point extended registers, XFi (16 registers)  
When FPSCR.FR = 0, XF0–XF15 are assigned to FPR0\_BANK1–FPR15\_BANK1.  
When FPSCR.FR = 1, XF0–XF15 are assigned to FPR0\_BANK0–FPR15\_BANK0.
- Single-precision floating-point extended register pairs, XD<sub>i</sub> (8 registers): An XD register comprises two XF registers  
XD0 = {XF0, XF1}, XD2 = {XF2, XF3}, XD4 = {XF4, XF5}, XD6 = {XF6, XF7},  
XD8 = {XF8, XF9}, XD10 = {XF10, XF11}, XD12 = {XF12, XF13}, XD14 = {XF14, XF15}

- Single-precision floating-point extended register matrix, XMTRX: XMTRX comprises all 16 XF registers

$$\text{XMTRX} = \begin{bmatrix} \text{XF0} & \text{XF4} & \text{XF8} & \text{XF12} \\ \text{XF1} & \text{XF5} & \text{XF9} & \text{XF13} \\ \text{XF2} & \text{XF6} & \text{XF10} & \text{XF14} \\ \text{XF3} & \text{XF7} & \text{XF11} & \text{XF15} \end{bmatrix}$$

<u>FPSCR.FR = 0</u>				<u>FPSCR.FR = 1</u>		
FV0	DR0	FR0	FPR0_BANK0	XF0	XD0	XMTRX
		FR1	FPR1_BANK0	XF1		
FV4	DR2	FR2	FPR2_BANK0	XF2	XD2	
		FR3	FPR3_BANK0	XF3		
		FR4	FPR4_BANK0	XF4	XD4	
FV8	DR6	FR5	FPR5_BANK0	XF5	XD6	
		FR6	FPR6_BANK0	XF6		
		FR7	FPR7_BANK0	XF7		
FV12	DR8	FR8	FPR8_BANK0	XF8	XD8	
		FR9	FPR9_BANK0	XF9		
		FR10	FPR10_BANK0	XF10	XD10	
FV12	DR10	FR11	FPR11_BANK0	XF11		
		FR12	FPR12_BANK0	XF12	XD12	
		FR13	FPR13_BANK0	XF13		
FV12	DR12	FR14	FPR14_BANK0	XF14	XD14	
		FR15	FPR15_BANK0	XF15		
XMTRX	XD0	XF0	FPR0_BANK1	FR0	DR0	FV0
		XF1	FPR1_BANK1	FR1	DR2	
XMTRX	XD2	XF2	FPR2_BANK1	FR2	DR2	
		XF3	FPR3_BANK1	FR3		
		XF4	FPR4_BANK1	FR4	DR4	FV4
XMTRX	XD4	XF5	FPR5_BANK1	FR5		
		XF6	FPR6_BANK1	FR6	DR6	
		XF7	FPR7_BANK1	FR7		
XMTRX	XD6	XF8	FPR8_BANK1	FR8	DR8	FV8
		XF9	FPR9_BANK1	FR9		
		XF10	FPR10_BANK1	FR10	DR10	
XMTRX	XD8	XF11	FPR11_BANK1	FR11		
		XF12	FPR12_BANK1	FR12	DR12	FV12
		XF13	FPR13_BANK1	FR13		
XMTRX	XD10	XF14	FPR14_BANK1	FR14	DR14	
		XF15	FPR15_BANK1	FR15		

**Figure 2.4 Floating-Point Registers**

**Programming Note:** After a reset, the values of FPR0\_BANK0–FPR15\_BANK0 and FPR0\_BANK1–FPR15\_BANK1 are undefined.

## 2.2.4 Control Registers

**Status register, SR (32 bits, privilege protection, initial value = 0111 0000 0000 0000 00XX 1111 00XX)**

31	30	29	28	27		16	15	14		10	9	8	7		4	3	2	1	0
—	MD	RB	BL		—	FD		—		M	Q		IMASK		—	S		T	

Note: —: Reserved. These bits are always read as 0, and should only be written with 0.

X: Undefined

- MD: Processor mode  
MD = 0: User mode (some instructions cannot be executed, and some resources cannot be accessed)  
MD = 1: Privileged mode
- RB: General register bank specifier in privileged mode (set to 1 by a reset, exception, or interrupt)  
RB = 0: R0\_BANK0–R7\_BANK0 are accessed as general registers R0–R7. (R0\_BANK1–R7\_BANK1 can be accessed using LDC/STC R0\_BANK–R7\_BANK instructions.)  
RB = 1: R0\_BANK1–R7\_BANK1 are accessed as general registers R0–R7. (R0\_BANK0–R7\_BANK0 can be accessed using LDC/STC R0\_BANK–R7\_BANK instructions.)
- BL: Exception/interrupt block bit (set to 1 by a reset, exception, or interrupt)  
BL = 1: Interrupt requests are masked. If a general exception other than a user break occurs while BL = 1, the processor switches to the reset state.
- FD: FPU disable bit (cleared to 0 by a reset)  
FD = 1: An FPU instruction causes a general FPU disable exception, and if the FPU instruction is in a delay slot, a slot FPU disable exception is generated. (FPU instructions: H'F\*\*\* instructions, LDC(.L)/STS(.L) instructions for FPUL/FPSCR)
- M, Q: Used by the DIV0S, DIV0U, and DIV1 instructions.
- IMASK: Interrupt mask level  
External interrupts of a lower level than IMASK are masked.
- S: Specifies a saturation operation for a MAC instruction.
- T: True/false condition or carry/borrow bit

**Saved status register, SSR (32 bits, privilege protection, initial value undefined):** The current contents of SR are saved to SSR in the event of an exception or interrupt.

**Saved program counter, SPC (32 bits, privilege protection, initial value undefined):** The address of an instruction at which an interrupt or exception occurs is saved to SPC.

**Global base register, GBR (32 bits, initial value undefined):** GBR is referenced as the base address in a GBR-referencing MOV instruction.

**Vector base register, VBR (32 bits, privilege protection, initial value = H'0000 0000):** VBR is referenced as the branch destination base address in the event of an exception or interrupt. For details, see section 5, Exceptions.

**Saved general register 15, SGR (32 bits, privilege protection, initial value undefined):** The contents of R15 are saved to SGR in the event of an exception or interrupt.

**Debug base register, DBR (32 bits, privilege protection, initial value undefined):** When the user break debug function is enabled (BRCR.UBDE = 1), DBR is referenced as the user break handler branch destination address instead of VBR.

### 2.2.5 System Registers

**Multiply-and-accumulate register high, MACH (32 bits, initial value undefined)**

**Multiply-and-accumulate register low, MACL (32 bits, initial value undefined)**

MACH/MACL is used for the added value in a MAC instruction, and to store a MAC instruction or MUL operation result.

**Procedure register, PR (32 bits, initial value undefined):** The return address is stored in PR in a subroutine call using a BSR, BSRF, or JSR instruction, and PR is referenced by the subroutine return instruction (RTS).

**Program counter, PC (32 bits, initial value = H'A000 0000):** PC indicates the instruction fetch address.

### Floating-point status/control register, FPSCR (32 bits, initial value = H'0004 0001)

31	22	21	20	19	18	17	12	11	7	6	2	1	0
—				FR	SZ	PR	DN	Cause	Enable	Flag	RM		

Note: —: Reserved. These bits are always read as 0, and should only be written with 0.

- **FR: Floating-point register bank**  
 FR = 0: FPR0\_BANK0–FPR15\_BANK0 are assigned to FR0–FR15; FPR0\_BANK1–FPR15\_BANK1 are assigned to XF0–XF15.  
 FR = 1: FPR0\_BANK0–FPR15\_BANK0 are assigned to XF0–XF15; FPR0\_BANK1–FPR15\_BANK1 are assigned to FR0–FR15.
- **SZ: Transfer size mode**  
 SZ = 0: The data size of the FMOV instruction is 32 bits.  
 SZ = 1: The data size of the FMOV instruction is a 32-bit register pair (64 bits).
- **PR: Precision mode**  
 PR = 0: Floating-point instructions are executed as single-precision operations.  
 PR = 1: Floating-point instructions are executed as double-precision operations (the result of instructions for which double-precision is not supported is undefined).  
 Do not set SZ and PR to 1 simultaneously; this setting is reserved.  
 [SZ, PR = 11]: Reserved (FPU operation instruction is undefined.)
- **DN: Denormalization mode**  
 DN = 0: A denormalized number is treated as such.  
 DN = 1: A denormalized number is treated as zero.

		<b>FPU Error (E)</b>	<b>Invalid Operation (V)</b>	<b>Division by Zero (Z)</b>	<b>Overflow (O)</b>	<b>Underflow (U)</b>	<b>Inexact (I)</b>
Cause	FPU exception cause field	Bit 17	Bit 16	Bit 15	Bit 14	Bit 13	Bit 12
Enable	FPU exception enable field	None	Bit 11	Bit 10	Bit 9	Bit 8	Bit 7
Flag	FPU exception flag field	None	Bit 6	Bit 5	Bit 4	Bit 3	Bit 2

When an FPU operation instruction is executed, the cause field is cleared to zero first. When the next FPU exception is requested, the corresponding bits in the cause field and flag field are set to 1. The flag field holds the status of the exception generated after the field was last cleared.

- RM: Rounding mode  
 RM = 00: Round to Nearest  
 RM = 01: Round to Zero  
 RM = 10: Reserved  
 RM = 11: Reserved
- Bits 22 to 31: Reserved

**Floating-point communication register, FPUL (32 bits, initial value undefined):** Data transfer between FPU registers and CPU registers is carried out via the FPUL register.

**Programming Note:** When SZ = 1 and big endian mode is selected, FMOV can be used for double-precision floating-point load or store operations. In little endian mode, two 32-bit data size moves must be executed, with SZ = 0, to load or store a double-precision floating-point number.

## 2.3 Memory-Mapped Registers

Appendix A shows the control registers mapped to memory. The control registers are double-mapped to the following two memory areas. All registers have two addresses.

H'1F00 0000–H'1FFF FFFF  
 H'FF00 0000–H'FFFF FFFF

These two areas are used as follows.

- H'1F00 0000–H'1FFF FFFF  
 This area must be accessed in address translation mode using the TLB. Since external memory is defined as a 29-bit address space in the SH7750 architecture, the TLB's physical page numbers do not cover a 32-bit address space. In address translation, the page numbers of this area can be set in the corresponding field of the TLB by accessing a memory-mapped register. The page numbers of this area should be used as the actual page numbers set in the TLB. When address translation is not performed, the operation of accesses to this area is undefined.
- H'FF00 0000–H'FFFF FFFF  
 This area must be accessed without address translation.  
 Do not access undefined locations in either area. The operation of an access to an undefined location is undefined. Also, memory-mapped registers must be accessed using a fixed data size. The operation of an access using an invalid data size is undefined.

**Programming Note:** Access to area H'FF00 0000–H'FFFF FFFF in user mode will cause an address error. Memory-mapped registers can be referenced in user mode by means of access that involves address translation.

## 2.4 Data Format in Registers

Register operands are always longwords (32 bits). When a memory operand is only a byte (8 bits) or a word (16 bits), it is sign-extended into a longword when loaded into a register.

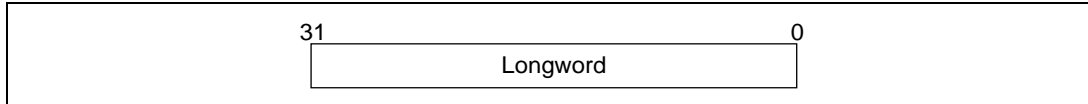

## 2.5 Data Formats in Memory

Memory data formats are classified into bytes, words, and longwords. Memory can be accessed in 8-bit byte, 16-bit word, or 32-bit longword form. A memory operand less than 32 bits in length is sign-extended before being loaded into a register.

A word operand must be accessed starting from a word boundary (even address of a 2-byte unit: address  $2n$ ), and a longword operand starting from a longword boundary (even address of a 4-byte unit: address  $4n$ ). An address error will result if this rule is not observed. A byte operand can be accessed from any address.

Big endian or little endian byte order can be selected for the data format. The endian should be set with the MD5 external pin in a power-on reset. Big endian is selected when the MD5 pin is low, and little endian when high. The endian cannot be changed dynamically. Bit positions are numbered left to right from most-significant to least-significant. Thus, in a 32-bit longword, the leftmost bit, bit 31, is the most significant bit and the rightmost bit, bit 0, is the least significant bit.

The data format in memory is shown in figure 2.5. In little endian mode, data written as byte-size (8 bits) should be read as byte size, and data written as word-size (16 bits) should be read as word size.

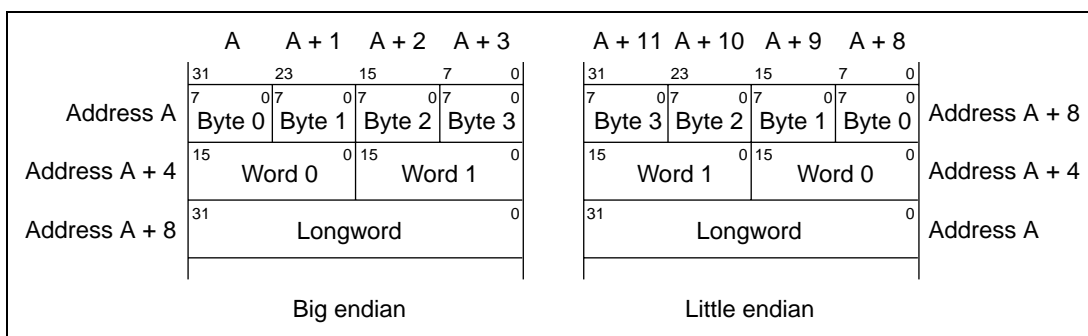

Figure 2.5 Data Formats In Memory



Note: The SH7750 does not support endian conversion for the 64-bit data format. Therefore, if double-precision floating-point format (64-bit) access is performed in little endian mode, the upper and lower 32 bits will be reversed.

## 2.6 Processor States

The SH7750 has five processor states: the reset state, exception-handling state, bus-released state, program execution state, and power-down state.

**Reset State:** In this state the CPU is reset. The reset state is entered when the  $\overline{\text{RESET}}$  pin goes low. The CPU enters the power-on reset state if the  $\overline{\text{MRESET}}$  pin is high, and the manual reset state if the  $\overline{\text{MRESET}}$  pin is low. For more information on resets, see section 5, Exceptions.

In the power-on reset state, the internal state of the CPU and the on-chip peripheral module registers are initialized. In the manual reset state, the internal state of the CPU and registers of on-chip peripheral modules other than the bus state controller (BSC) are initialized. Since the bus state controller (BSC) is not initialized in the manual reset state, refreshing operations continue. Refer to the register configurations in the relevant sections for further details.

**Exception-Handling State:** This is a transient state during which the CPU's processor state flow is altered by a reset, general exception, or interrupt exception handling source.

In the case of a reset, the CPU branches to address H'A000 0000 and starts executing the user-coded exception handling program.

In the case of a general exception or interrupt, the program counter (PC) contents are saved in the saved program counter (SPC), the status register (SR) contents are saved in the saved status register (SSR), and the R15 contents are saved in saved general register 15 (SGR). The CPU branches to the start address of the user-coded exception service routine found from the sum of the contents of the vector base address and the vector offset. See section 5, Exceptions, for more information on resets, general exceptions, and interrupts.

**Program Execution State:** In this state the CPU executes program instructions in sequence.

**Power-Down State:** In the power-down state, CPU operation halts and power consumption is reduced. The power-down state is entered by executing a SLEEP instruction. There are two modes in the power-down state: sleep mode and standby mode. For details, see section 9, Power-Down Modes.

**Bus-Released State:** In this state the CPU has released the bus to a device that requested it.

Transitions between the states are shown in figure 2.6.

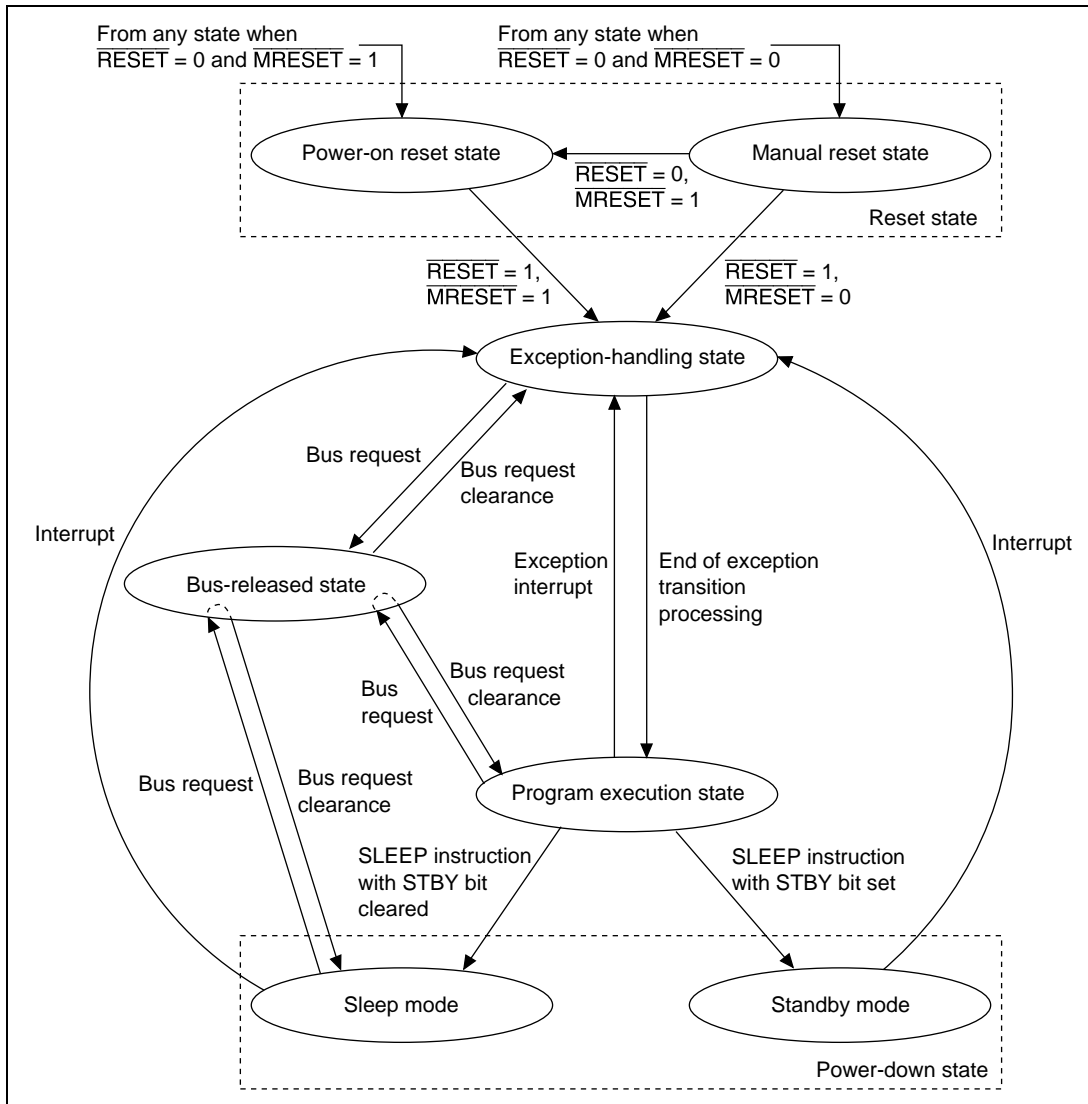

**Figure 2.6 Processor State Transitions**

## 2.7 Processor Modes

There are two processor modes: user mode and privileged mode. The processor mode is determined by the processor mode bit (MD) in the status register (SR). User mode is selected when the MD bit is cleared to 0, and privileged mode when the MD bit is set to 1. When the reset state or exception state is entered, the MD bit is set to 1. When exception handling ends, the MD bit is cleared to 0 and user mode is entered. There are certain registers and bits which can only be accessed in privileged mode.

## Section 3 Memory Management Unit (MMU)

### 3.1 Overview

#### 3.1.1 Features

The SH7750 can handle 29-bit external memory space from an 8-bit address space identifier and 32-bit logical (virtual) address space. Address translation from virtual address to physical address is performed using the memory management unit (MMU) built into the SH7750. The MMU performs high-speed address translation by caching user-created address translation table information in an address translation buffer (translation lookaside buffer: TLB). The SH7750 has four instruction TLB (ITLB) entries and 64 unified TLB (UTLB) entries. UTLB copies are stored in the ITLB by hardware. A paging system is used for address translation, with support for four page sizes (1, 4, and 64 kbytes, and 1 Mbyte). It is possible to set the virtual address space access right and implement storage protection independently for privileged mode and user mode.

#### 3.1.2 Role of the MMU

The MMU was conceived as a means of making efficient use of physical memory. As shown in figure 3.1, when a process is smaller in size than the physical memory, the entire process can be mapped onto physical memory, but if the process increases in size to the point where it does not fit into physical memory, it becomes necessary to divide the process into smaller parts, and map the parts requiring execution onto physical memory on an ad hoc basis ((1)). Having this mapping onto physical memory executed consciously by the process itself imposes a heavy burden on the process. The virtual memory system was devised as a means of handling all physical memory mapping to reduce this burden ((2)). With a virtual memory system, the size of the available virtual memory is much larger than the actual physical memory, and processes are mapped onto this virtual memory. Thus processes only have to consider their operation in virtual memory, and mapping from virtual memory to physical memory is handled by the MMU. The MMU is normally managed by the OS, and physical memory switching is carried out so as to enable the virtual memory required by a task to be mapped smoothly onto physical memory. Physical memory switching is performed via secondary storage, etc.

The virtual memory system that came into being in this way works to best effect in a time sharing system (TSS) that allows a number of processes to run simultaneously ((3)). Running a number of processes in a TSS did not increase efficiency since each process had to take account of physical memory mapping. Efficiency is improved and the load on each process reduced by the use of a virtual memory system ((4)). In this system, virtual memory is allocated to each process. The task of the MMU is to map a number of virtual memory areas onto physical memory in an efficient manner. It is also provided with memory protection functions to prevent a process from inadvertently accessing another process's physical memory.

When address translation from virtual memory to physical memory is performed using the MMU, it may happen that the translation information has not been recorded in the MMU, or the virtual memory of a different process is accessed by mistake. In such cases, the MMU will generate an exception, change the physical memory mapping, and record the new address translation information.

Although the functions of the MMU could be implemented by software alone, having address translation performed by software each time a process accessed physical memory would be very inefficient. For this reason, a buffer for address translation (the translation lookaside buffer: TLB) is provided in hardware, and frequently used address translation information is placed here. The TLB can be described as a cache for address translation information. However, unlike a cache, if address translation fails—that is, if an exception occurs—switching of the address translation information is normally performed by software. Thus memory management can be performed in a flexible manner by software.

There are two methods by which the MMU can perform mapping from virtual memory to physical memory: the paging method, using fixed-length address translation, and the segment method, using variable-length address translation. With the paging method, the unit of translation is a fixed-size address space called a page (usually from 1 to 64 kbytes in size).

In the following descriptions, the address space in virtual memory in the SH7750 is referred to as virtual address space, and the address space in physical memory as physical address space.

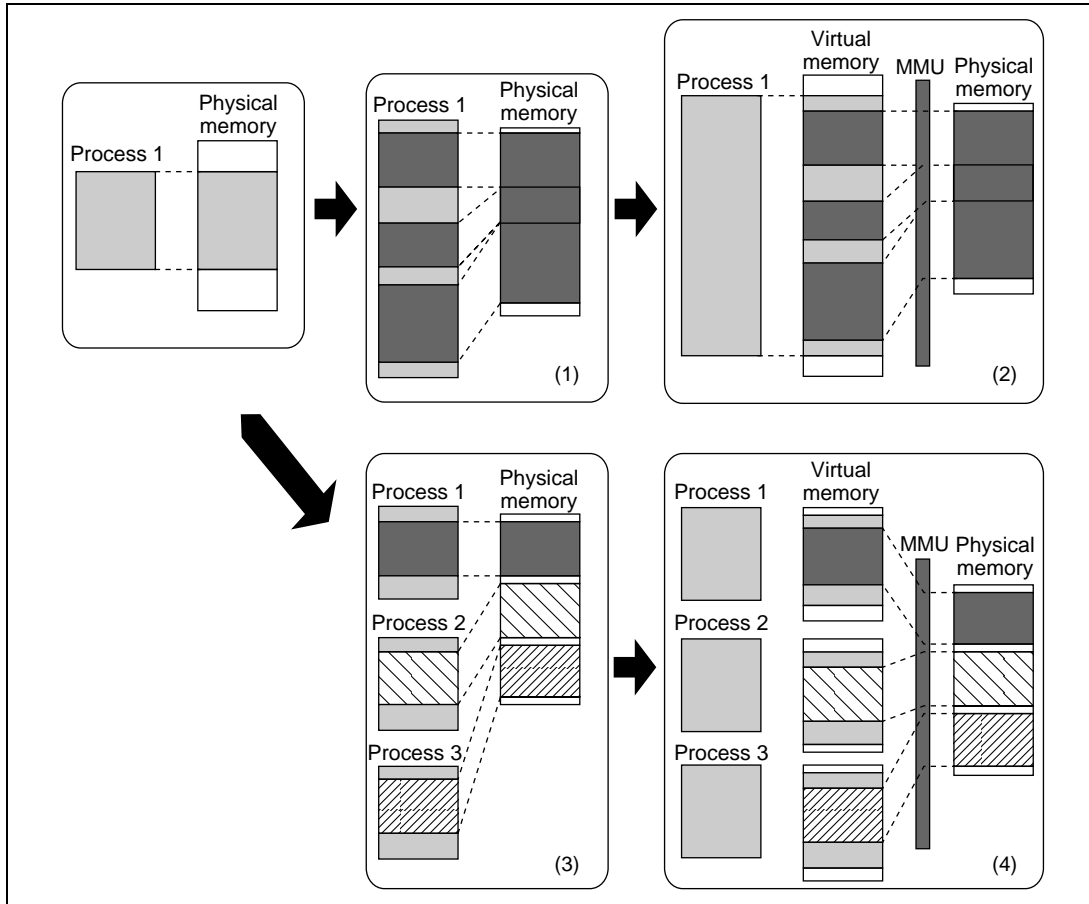

**Figure 3.1 Role of the MMU**

### 3.1.3 Register Configuration

The MMU registers are shown in table 3.1.

**Table 3.1 MMU Registers**

Name	Abbrevia- tion	R/W	Initial Value* <sup>1</sup>	P4 Address* <sup>2</sup>	Area 7 Address* <sup>2</sup>	Access Size
Page table entry high register	PTEH	R/W	Undefined	H'FF00 0000	H'1F00 0000	32
Page table entry low register	PTL	R/W	Undefined	H'FF00 0004	H'1F00 0004	32
Page table entry assistance register	PTEA	R/W	Undefined	H'FF00 0034	H'1F00 0034	32
Translation table base register	TTB	R/W	Undefined	H'FF00 0008	H'1F00 0008	32
TLB exception address register	TEA	R/W	Undefined	H'FF00 000C	H'1F00 000C	32
MMU control register	MMUCR	R/W	H'0000 0000	H'FF00 0010	H'1F00 0010	32

Notes: 1. The initial value is the value after a power-on reset or manual reset.

2. This is the address when using the virtual/physical address space P4 area. When making an access from physical address space area 7 using the TLB, the upper 3 bits of the address are ignored.

### 3.1.4 Caution

Operation is not guaranteed if an area designated as a reserved area in this manual is accessed.

### 3.2 Register Descriptions

There are six MMU-related registers.

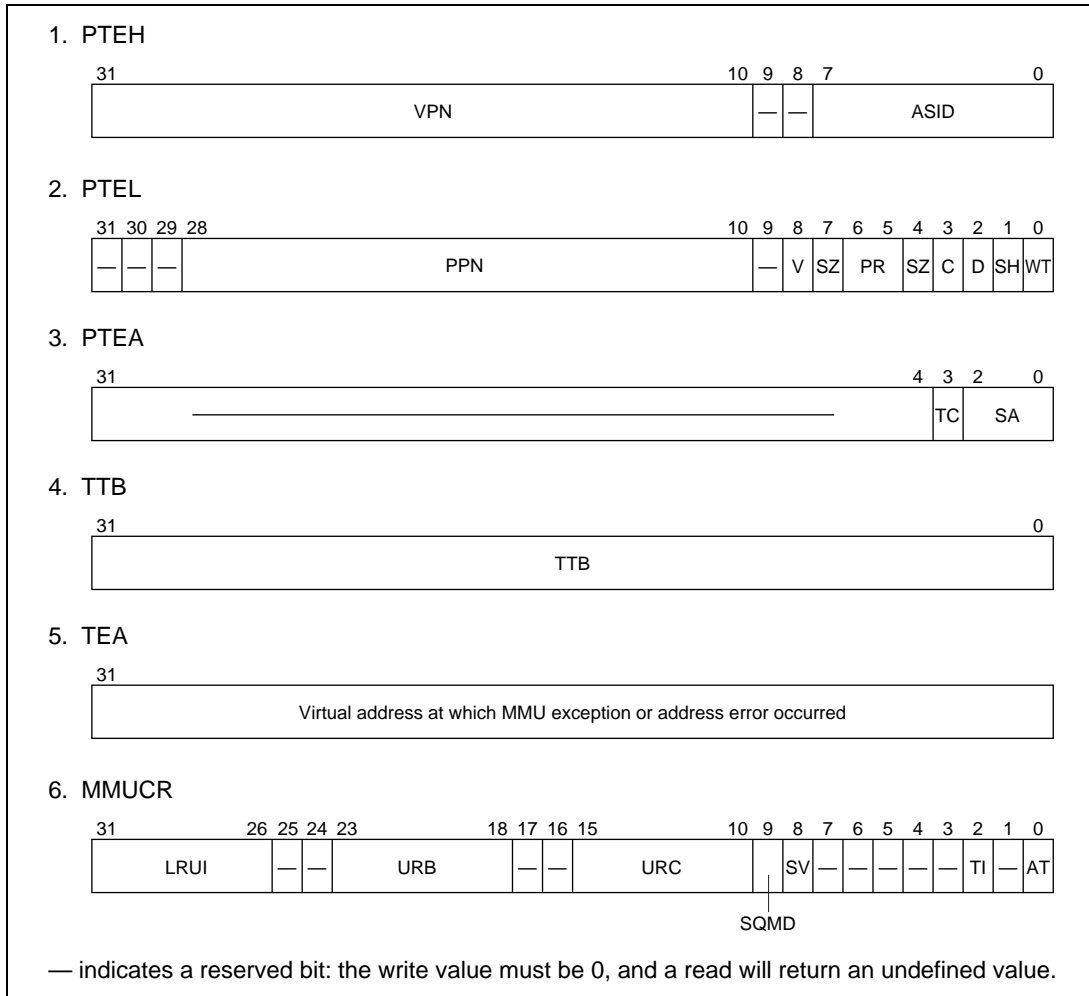

Figure 3.2 MMU-Related Registers

**1. Page table entry high register (PTEH):** Longword access to PTEH can be performed from H'FF00 0000 in the P4 area and H'1F00 0000 in area 7. PTEH consists of the virtual page number (VPN) and address space identifier (ASID). When an MMU exception or address error exception occurs, the VPN of the virtual address at which the exception occurred is set in the VPN field by hardware. VPN varies according to the page size, but the VPN set by hardware when an exception occurs consists of the upper 22 bits of the virtual address which caused the exception. VPN setting can also be carried out by software. The number of the currently executing process is set in the ASID field by software. ASID is not updated by hardware. VPN and ASID are recorded in the UTLB by means of the LDLTB instruction.

**2. Page table entry low register (PTEL):** Longword access to PTEL can be performed from H'FF00 0004 in the P4 area and H'1F00 0004 in area 7. PTEL is used to hold the physical page number and page management information to be recorded in the UTLB by means of the LDLTB instruction. The contents of this register are not changed unless a software directive is issued.

**3. Page table entry assistance register (PTEA):** Longword access to PTEA can be performed from H'FF00 0034 in the P4 area and H'1F00 0034 in area 7. PTEL is used to store assistance bits for PCMCIA access to the UTLB by means of the LDLTB instruction. The contents of this register are not changed unless a software directive is issued.

**4. Translation table base register (TTB):** Longword access to TTB can be performed from H'FF00 0008 in the P4 area and H'1F00 0008 in area 7. TTB is used, for example, to hold the base address of the currently used page table. The contents of TTB are not changed unless a software directive is issued. This register can be freely used by software.

**5. TLB exception address register (TEA):** Longword access to TEA can be performed from H'FF00 000C in the P4 area and H'1F00 000C in area 7. After an MMU exception or address error exception occurs, the virtual address at which the exception occurred is set in TEA by hardware. The contents of this register can be changed by software.

**6. MMU control register (MMUCR):** MMUCR contains the following bits:

LRUI: Least recently used ITLB  
URB: UTLB replace boundary  
URC: UTLB replace counter  
SQMD: Store queue mode bit  
SV: Single virtual mode bit  
TI: TLB invalidate  
AT: Address translation bit

Longword access to MMUCR can be performed from H'FF00 0010 in the P4 area and H'1F00 0010 in area 7. The individual bits perform MMU settings as shown below. Therefore, MMUCR rewriting should be performed by a program in the P1 or P2 area. After MMUCR is updated, an instruction that performs data access to the P0, P3, U0, or store queue area should be located at least four instructions after the MMUCR update instruction. Also, a branch instruction to the P0,



P3, or U0 area should be located at least eight instructions after the MMUCR update instruction. MMUCR contents can be changed by software. The LRUI bits and URC bits may also be updated by hardware.

- **LRUI:** The LRU (least recently used) method is used to decide the ITLB entry to be replaced in the event of an ITLB miss. The entry to be purged from the ITLB can be confirmed using the LRUI bits. LRUI is updated by means of the algorithm shown below. A dash in this table means that updating is not performed.

	LRUI					
	[5]	[4]	[3]	[2]	[1]	[0]
When ITLB entry 0 is used	0	0	0	—	—	—
When ITLB entry 1 is used	1	—	—	0	0	—
When ITLB entry 2 is used	—	1	—	1	—	0
When ITLB entry 3 is used	—	—	1	—	1	1
Other than the above	—	—	—	—	—	—

When the LRUI bit settings are as shown below, the corresponding ITLB entry is updated by an ITLB miss. An asterisk in this table means “don’t care”.

	LRUI					
	[5]	[4]	[3]	[2]	[1]	[0]
ITLB entry 0 is updated	1	1	1	*	*	*
ITLB entry 1 is updated	0	*	*	1	1	*
ITLB entry 2 is updated	*	0	*	0	*	1
ITLB entry 3 is updated	*	*	0	*	0	0
Other than the above	Setting prohibited					

Ensure that values for which “Setting prohibited” is indicated in the above table are not set at the discretion of software. After a power-on or manual reset the LRUI bits are initialized to 0, and therefore a prohibited setting is never made by a hardware update.

- **URB:** Bits that indicate the UTLB entry boundary at which replacement is to be performed. Valid only when  $URB > 0$ .
- **URC:** Random counter for indicating the UTLB entry for which replacement is to be performed with an LDTLB instruction. URC is incremented each time the UTLB is accessed. When  $URB > 0$ , URC is reset to 0 when the condition  $URC = URB$  occurs. Also note that, if a value is written to URC by software which results in the condition  $URC > URB$ , incrementing

is first performed in excess of URB until URC = H'3F. URC is not incremented by an LDTLB instruction.

- **SQMD:** Store queue mode bit. Specifies the right of access to the store queues.  
0: User/privileged access possible  
1: Privileged access possible (address error exception in case of user access)
- **SV:** Bit that switches between single virtual memory mode and multiple virtual memory mode.  
0: Multiple virtual memory mode  
1: Single virtual memory mode  
When this bit is changed, ensure that 1 is also written to the TI bit.
- **TI:** Writing 1 to this bit invalidates (clears to 0) all valid UTLB/ITLB bits. This bit always returns 0 when read.
- **AT:** Specifies MMU enabling or disabling.  
0: MMU disabled  
1: MMU enabled  
MMU exceptions are not generated when the AT bit is 0. In the case of software that does not use the MMU, therefore, the AT bit should be cleared to 0.

### **3.3 Memory Space**

#### **3.3.1 Physical Memory Space**

The SH7750 supports a 32-bit physical memory space, and can access a 4-Gbyte address space. When the MMUCR.AT bit is cleared to 0 and the MMU is disabled, the address space is this physical memory space. The physical memory space is divided into a number of areas, as shown in figure 3.3. The physical memory space is permanently mapped onto 29-bit external memory space; this correspondence can be implemented by ignoring the upper 3 bits of the physical memory space addresses. In privileged mode, the 4-Gbyte space from the P0 area to the P4 area can be accessed. In user mode, a 2-Gbyte space in the U0 area can be accessed. Accessing the P1 to P4 areas (except the store queue area) in user mode will cause an address error.

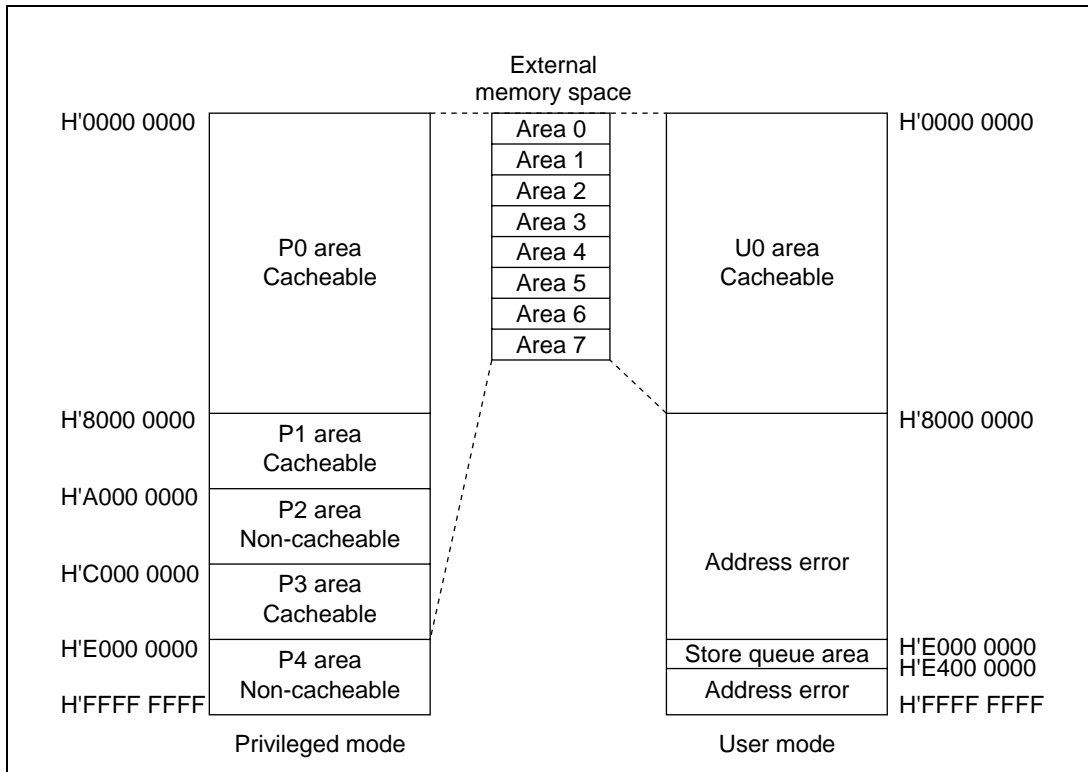

**Figure 3.3 Physical Memory Space (MMUCR.AT = 0)**

**P0, P1, P3, U0 Areas:** The P0, P1, P3, and U0 areas can be accessed using the cache. Whether or not the cache is used is determined by the cache control register (CCR). When the cache is used, with the exception of the P1 area, switching between the copy-back method and the write-through method for write accesses is specified by the CCR.WT bit. For the P1 area, switching is specified by the CCR.CB bit. Zeroizing the upper 3 bits of an address in these areas gives the corresponding external memory space address. However, since area 7 in the external memory space is a reserved area, a reserved area also appears in these areas.

**P2 Area:** The P2 area cannot be accessed using the cache. In the P2 area, zeroizing the upper 3 bits of an address gives the corresponding external memory space address. However, since area 7 in the external memory space is a reserved area, a reserved area also appears in this area.

**P4 Area:** The P4 area is mapped onto SH7750 on-chip I/O channels. This area cannot be accessed using the cache. The P4 area is shown in detail in figure 3.4.

H'E000 0000	Store queue
H'E400 0000	
	Reserved area
H'F000 0000	Instruction cache address array
H'F100 0000	Instruction cache data array
H'F200 0000	Instruction TLB address array
H'F300 0000	Instruction TLB data arrays 1 and 2
H'F400 0000	Operand cache address array
H'F500 0000	Operand cache data array
H'F600 0000	Unified TLB address array
H'F700 0000	Unified TLB data arrays 1 and 2
H'F800 0000	Reserved area
H'FF00 0000	Control register area

**Figure 3.4 P4 Area**

The area from H'E000 0000 to H'E3FF FFFF comprises addresses for accessing the store queues (SQs). When the MMU is disabled (MMUCR.AT = 0), the SQ access right is specified by the MMUCR.SQMD bit. For details, see section 4.6, Store Queues.

The area from H'F000 0000 to H'F0FF FFFF is used for direct access to the instruction cache address array. For details, see section 4.5.1, IC Address Array.

The area from H'F100 0000 to H'F1FF FFFF is used for direct access to the instruction cache data array. For details, see section 4.5.2, IC Data Array.

The area from H'F200 0000 to H'F2FF FFFF is used for direct access to the instruction TLB address array. For details, see section 3.7.1, ITLB Address Array.

The area from H'F300 0000 to H'F3FF FFFF is used for direct access to instruction TLB data arrays 1 and 2. For details, see sections 3.7.2, ITLB Data Array 1, and 3.7.3, ITLB Data Array 2.

The area from H'F400 0000 to H'F4FF FFFF is used for direct access to the operand cache address array. For details, see section 4.5.3, OC Address Array.

The area from H'F500 0000 to H'F5FF FFFF is used for direct access to the operand cache data array. For details, see section 4.5.4, OC Data Array.

The area from H'F600 0000 to H'F6FF FFFF is used for direct access to the unified TLB address array. For details, see section 3.7.4, UTLB Address Array.

The area from H'F700 0000 to H'F7FF FFFF is used for direct access to unified TLB data arrays 1 and 2. For details, see sections 3.7.5, UTLB Data Array 1, and 3.7.6, UTLB Data Array 2.

The area from H'FF00 0000 to H'FFFF FFFF is the on-chip peripheral module control register area.

### 3.3.2 External Memory Space

The SH7750 supports a 29-bit external memory space. The external memory space is divided into eight areas as shown in figure 3.5. Areas 0 to 6 relate to memory, such as SRAM, synchronous DRAM, DRAM, and PCMCIA. Area 7 is a reserved area. For details, see section 13, Bus State Controller (BSC), in the Hardware Manual.

H'0000 0000	Area 0
H'0400 0000	Area 1
H'0800 0000	Area 2
H'0C00 0000	Area 3
H'1000 0000	Area 4
H'1400 0000	Area 5
H'1800 0000	Area 6
H'1C00 0000 H'1FFF FFFF	Area 7 (reserved area)

**Figure 3.5 External Memory Space**

### 3.3.3 Virtual Memory Space

Setting the MMUCR.AT bit to 1 enables the P0, P3, and U0 areas of the physical memory space in the SH7750 to be mapped onto any external memory space in 1-, 4-, or 64-kbyte, or 1-Mbyte, page units. By using an 8-bit address space identifier, the P0, U0, P3, and store queue areas can be increased to a maximum of 256. This is called the virtual memory space. Mapping from virtual memory space to 29-bit external memory space is carried out using the TLB. Only when area 7 in external memory space is accessed using virtual memory space, addresses H'1F00 0000 to H'1FFF FFFF of area 7 are not designated as a reserved area, but are equivalent to the P4 area control register area in the physical memory space. Virtual memory space is illustrated in figure 3.6.

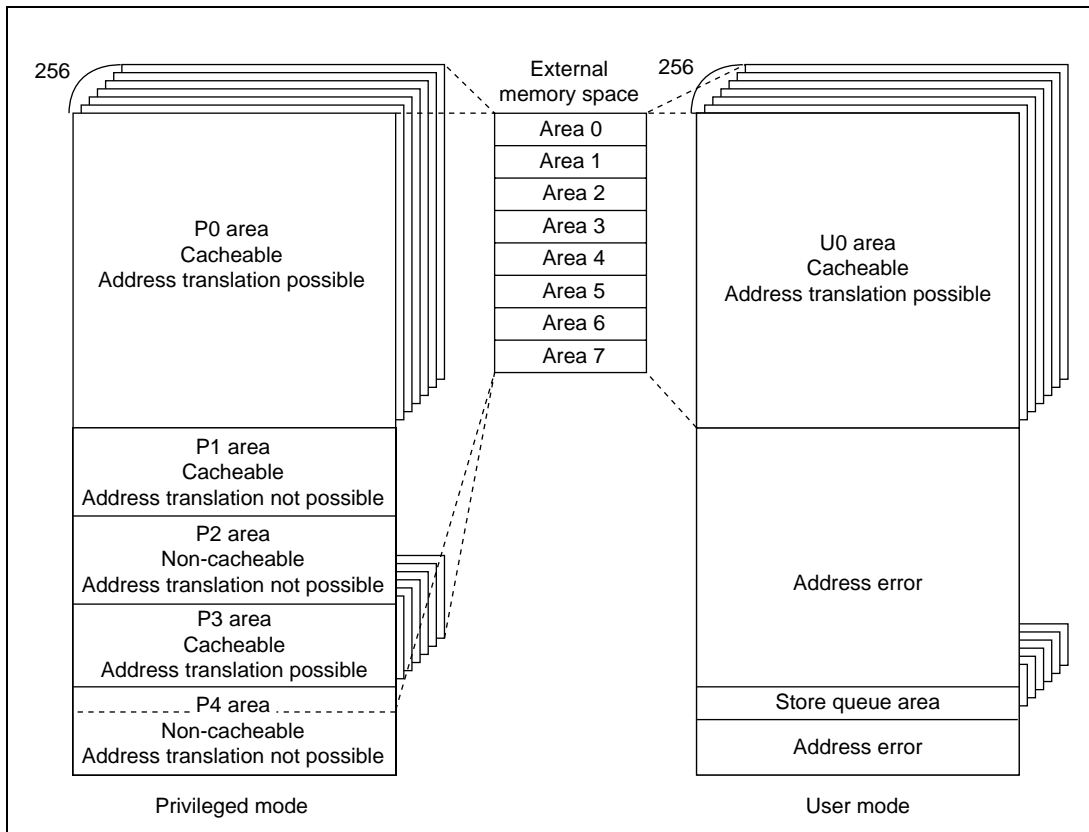

**Figure 3.6 Virtual Memory Space (MMUCR.AT = 1)**

**P0, P3, U0 Areas:** The P0 area (excluding addresses H'7C00 0000 to H'7FFF FFFF), P3 area, and U0 area allow access using the cache and address translation using the TLB. These areas can be mapped onto any external memory space in 1-, 4-, or 64-kbyte, or 1-Mbyte, page units. When CCR is in the cache-enabled state and the TLB enable bit (C bit) is 1, accesses can be performed using the cache. In write accesses to the cache, switching between the copy-back method and the

write-through method is indicated by the TLB write-through bit (WT bit), and is specified in page units.

Only when the P0, P3, and U0 areas are mapped onto external memory space by means of the TLB, addresses H'1F00 0000 to H'1FFF FFFF of area 7 in external memory space are allocated to the control register area. This enables on-chip peripheral module control registers to be accessed from the U0 area in user mode. In this case, the C bit for the corresponding page must be cleared to 0.

In the cache enabled state, when areas P0, P3, and U0 are mapped onto the PCMCIA space by means of TLB, it is necessary either to specify 1 for the WT bit or to specify 0 for the C bit; it is not possible to use copy-back mode cache for the PCMCIA space.

**P1, P2, P4 Areas:** Address translation using the TLB cannot be performed for the P1, P2, or P4 area (except for the store queue area). Accesses to these areas are the same as for physical memory space. The store queue area can be mapped onto any external memory space by the MMU. However, operation in the case of an exception differs from that for normal P0, U0, and P3 spaces. For details, see section 4.6, Store Queues.

### 3.3.4 On-Chip RAM Space

In the SH7750, half (8 kbytes) of the instruction cache (16 kbytes) can be used as on-chip RAM. This can be done by changing the CCR settings.

When the operand cache is used as on-chip RAM (CCR.ORA = 1), P0 area addresses H'7C00 0000 to H'7FFF FFFF are an on-chip RAM area. Data accesses (byte/word/longword/quadword) can be used in this area. This area can only be used in RAM mode.

### 3.3.5 Address Translation

When the MMU is used, the virtual address space is divided into units called pages, and translation to physical addresses is carried out in these page units. The address translation table in external memory contains the physical addresses corresponding to virtual addresses and additional information such as memory protection codes. Fast address translation is achieved by caching the contents of the address translation table located in external memory into the TLB. In the SH7750, basically, the ITLB is used for instruction accesses and the UTLB for data accesses. In the event of an access to an area other than the P4 area, the accessed virtual address is translated to a physical address. If the virtual address belongs to the P1 or P2 area, the physical address is uniquely determined without accessing the TLB. If the virtual address belongs to the P0, U0, or P3 area, the TLB is searched using the virtual address, and if the virtual address is recorded in the TLB, a TLB hit is made and the corresponding physical address is read from the TLB. If the accessed virtual address is not recorded in the TLB, a TLB miss exception is generated and processing switches to the TLB miss exception routine. In the TLB miss exception routine, the

address translation table in external memory is searched, and the corresponding physical address and page management information are recorded in the TLB. After the return from the exception handling routine, the instruction which caused the TLB miss exception is re-executed.

### **3.3.6 Single Virtual Memory Mode and Multiple Virtual Memory Mode**

There are two virtual memory systems, single virtual memory and multiple virtual memory, either of which can be selected with the MMUCR.SV bit. In the single virtual memory system, a number of processes run simultaneously, using virtual address space on an exclusive basis, and the physical address corresponding to a particular virtual address is uniquely determined. In the multiple virtual memory system, a number of processes run while sharing the virtual address space, and a particular virtual address may be translated into different physical addresses depending on the process. The only difference between the single virtual memory and multiple virtual memory systems in terms of operation is in the TLB address comparison method (see section 3.4.3, Address Translation Method).

### **3.3.7 Address Space Identifier (ASID)**

In multiple virtual memory mode, the 8-bit address space identifier (ASID) is used to distinguish between processes running simultaneously while sharing the virtual address space. Software can set the ASID of the currently executing process in PTEH in the MMU. The TLB does not have to be purged when processes are switched by means of ASID.

In single virtual memory mode, ASID is used to provide memory protection for processes running simultaneously while using the virtual memory space on an exclusive basis.

## **3.4 TLB Functions**

### **3.4.1 Unified TLB (UTLB) Configuration**

The unified TLB (UTLB) is so called because of its use for the following two purposes:

1. To translate a virtual address to a physical address in a data access
2. As a table of address translation information to be recorded in the instruction TLB in the event of an ITLB miss

Information in the address translation table located in external memory is cached into the UTLB. The address translation table contains virtual page numbers and address space identifiers, and corresponding physical page numbers and page management information. Figure 3.7 shows the overall configuration of the UTLB. The UTLB consists of 64 fully-associative type entries. Figure 3.8 shows the relationship between the address format and page size.



Entry 0	ASID [7:0]	VPN [31:10]	V	PPN [28:10]	SZ [1:0]	SH	C	PR [1:0]	D	WT	SA [2:0]	TC
Entry 1	ASID [7:0]	VPN [31:10]	V	PPN [28:10]	SZ [1:0]	SH	C	PR [1:0]	D	WT	SA [2:0]	TC
Entry 2	ASID [7:0]	VPN [31:10]	V	PPN [28:10]	SZ [1:0]	SH	C	PR [1:0]	D	WT	SA [2:0]	TC
		⋮										
Entry 63	ASID [7:0]	VPN [31:10]	V	PPN [28:10]	SZ [1:0]	SH	C	PR [1:0]	D	WT	SA [2:0]	TC

**Figure 3.7 UTLB Configuration**

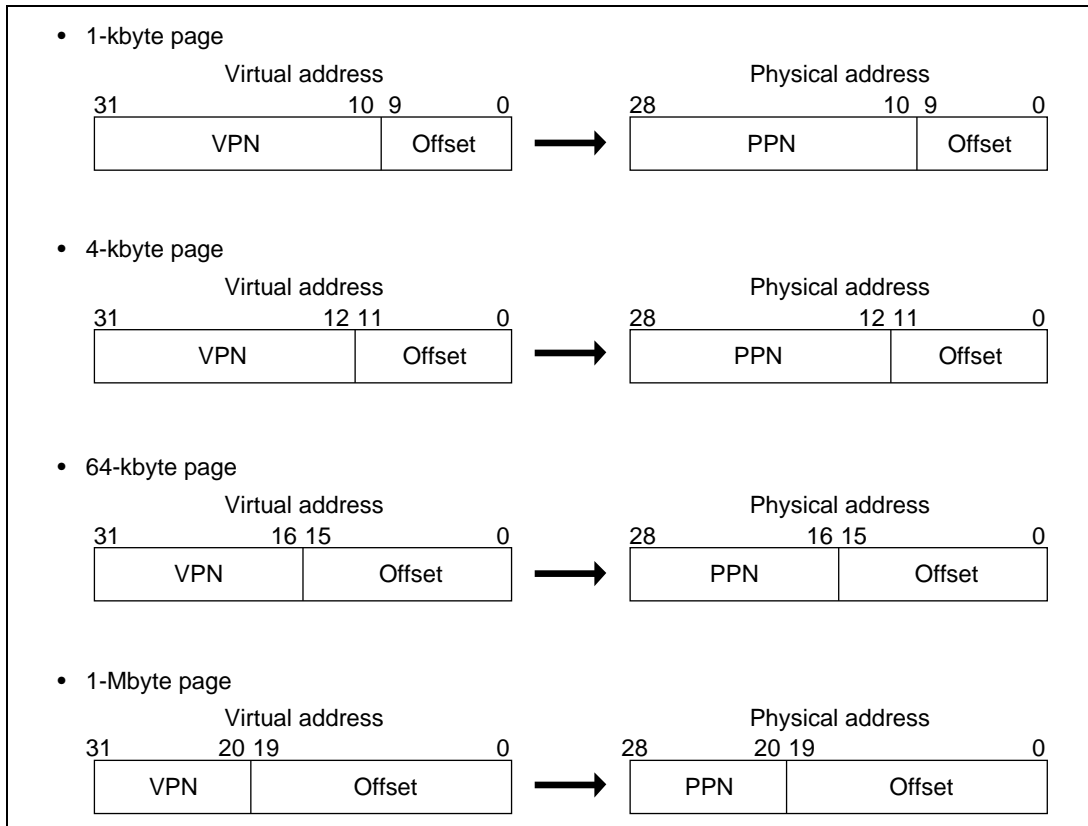

**Figure 3.8 Relationship between Page Size and Address Format**

- VPN: Virtual page number
  - For 1-kbyte page: upper 22 bits of virtual address
  - For 4-kbyte page: upper 20 bits of virtual address
  - For 64-kbyte page: upper 16 bits of virtual address
  - For 1-Mbyte page: upper 12 bits of virtual address

- **ASID: Address space identifier**  
Indicates the process that can access a virtual page.  
In single virtual memory mode and user mode, or in multiple virtual memory mode, if the SH bit is 0, this identifier is compared with the ASID in PTEH when address comparison is performed.
- **SH: Share status bit**  
When 0, pages are not shared by processes.  
When 1, pages are shared by processes.
- **SZ: Page size bits**  
Specify the page size.  
00: 1-kbyte page  
01: 4-kbyte page  
10: 64-kbyte page  
11: 1-Mbyte page
- **V: Validity bit**  
Indicates whether the entry is valid.  
0: Invalid  
1: Valid  
Cleared to 0 by a power-on reset.  
Not affected by a manual reset.
- **PPN: Physical page number**  
Upper 22 bits of the physical address.  
With a 1-kbyte page, PPN bits [28:10] are valid.  
With a 4-kbyte page, PPN bits [28:12] are valid.  
With a 64-kbyte page, PPN bits [28:16] are valid.  
With a 1-Mbyte page, PPN bits [28:20] are valid.  
The synonym problem must be taken into account when setting the PPN (see section 3.5.5, Avoiding Synonym Problems).
- **PR: Protection key data**  
2-bit data expressing the page access right as a code.  
00: Can be read only, in privileged mode  
01: Can be read and written in privileged mode  
10: Can be read only, in privileged or user mode  
11: Can be read and written in privileged mode or user mode

- **C: Cacheability bit**  
Indicates whether a page is cacheable.  
0: Not cacheable  
1: Cacheable  
When control register space is mapped, this bit must be cleared to 0.  
When performing PCMCIA space mapping in the cache enabled state, either clear this bit to 0 or set the WT bit to 1.
- **D: Dirty bit**  
Indicates whether a write has been performed to a page.  
0: Write has not been performed  
1: Write has been performed
- **WT: Write-through bit**  
Specifies the cache write mode.  
0: Copy-back mode  
1: Write-through mode  
When performing PCMCIA space mapping in the cache enabled state, either set this bit to 1 or clear the C bit to 0.
- **SA: Space attribute bits**  
Valid only when the page is mapped onto PCMCIA connected to area 5 or 6.  
000: Undefined  
001: Variable-size I/O space (base size according to  $\overline{\text{IOIS16}}$  signal)  
010: 8-bit I/O space  
011: 16-bit I/O space  
100: 8-bit common memory space  
101: 16-bit common memory space  
110: 8-bit attribute memory space  
111: 16-bit attribute memory space
- **TC: Timing control bit**  
Used to select wait control register bits in the bus control unit for areas 5 and 6.  
0: WCR2 (A5W2–A5W0) and PCR (A5PCW1–A5PCW0, A5TED2–A5TED0, A5TEH2–A5TEH0) are used  
1: WCR2 (A6W2–A6W0) and PCR (A6PCW1–A6PCW0, A6TED2–A6TED0, A6TEH2–A6TEH0) are used

### 3.4.2 Instruction TLB (ITLB) Configuration

The ITLB is used to translate a virtual address to a physical address in an instruction access. Information in the address translation table located in the UTLB is cached into the ITLB. Figure 3.9 shows the overall configuration of the ITLB. The ITLB consists of 4 fully-associative type entries. The address translation information is almost the same as that in the UTLB, but with the following differences:

1. D and WT bits are not supported.
2. There is only one PR bit, corresponding to the upper of the PR bits in the UTLB.

Entry 0	ASID [7:0]	VPN [31:10]	V	PPN [28:10]	SZ [1:0]	SH	C	PR	SA [2:0]	TC
Entry 1	ASID [7:0]	VPN [31:10]	V	PPN [28:10]	SZ [1:0]	SH	C	PR	SA [2:0]	TC
Entry 2	ASID [7:0]	VPN [31:10]	V	PPN [28:10]	SZ [1:0]	SH	C	PR	SA [2:0]	TC
Entry 3	ASID [7:0]	VPN [31:10]	V	PPN [28:10]	SZ [1:0]	SH	C	PR	SA [2:0]	TC

**Figure 3.9 ITLB Configuration**

### 3.4.3 Address Translation Method

Figures 3.10 and 3.11 show flowcharts of memory accesses using the UTLB and ITLB.

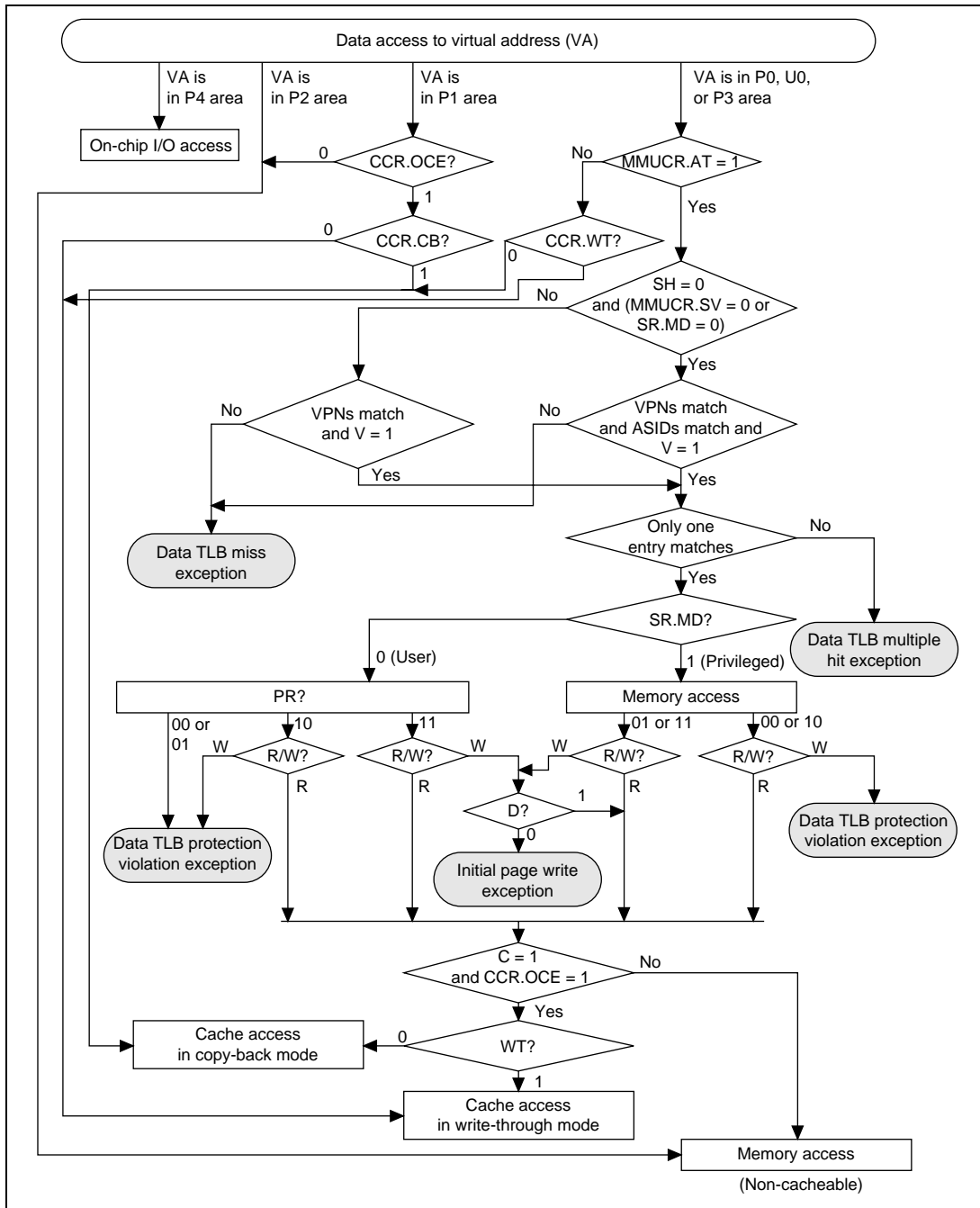

Figure 3.10 Flowchart of Memory Access Using UTLB

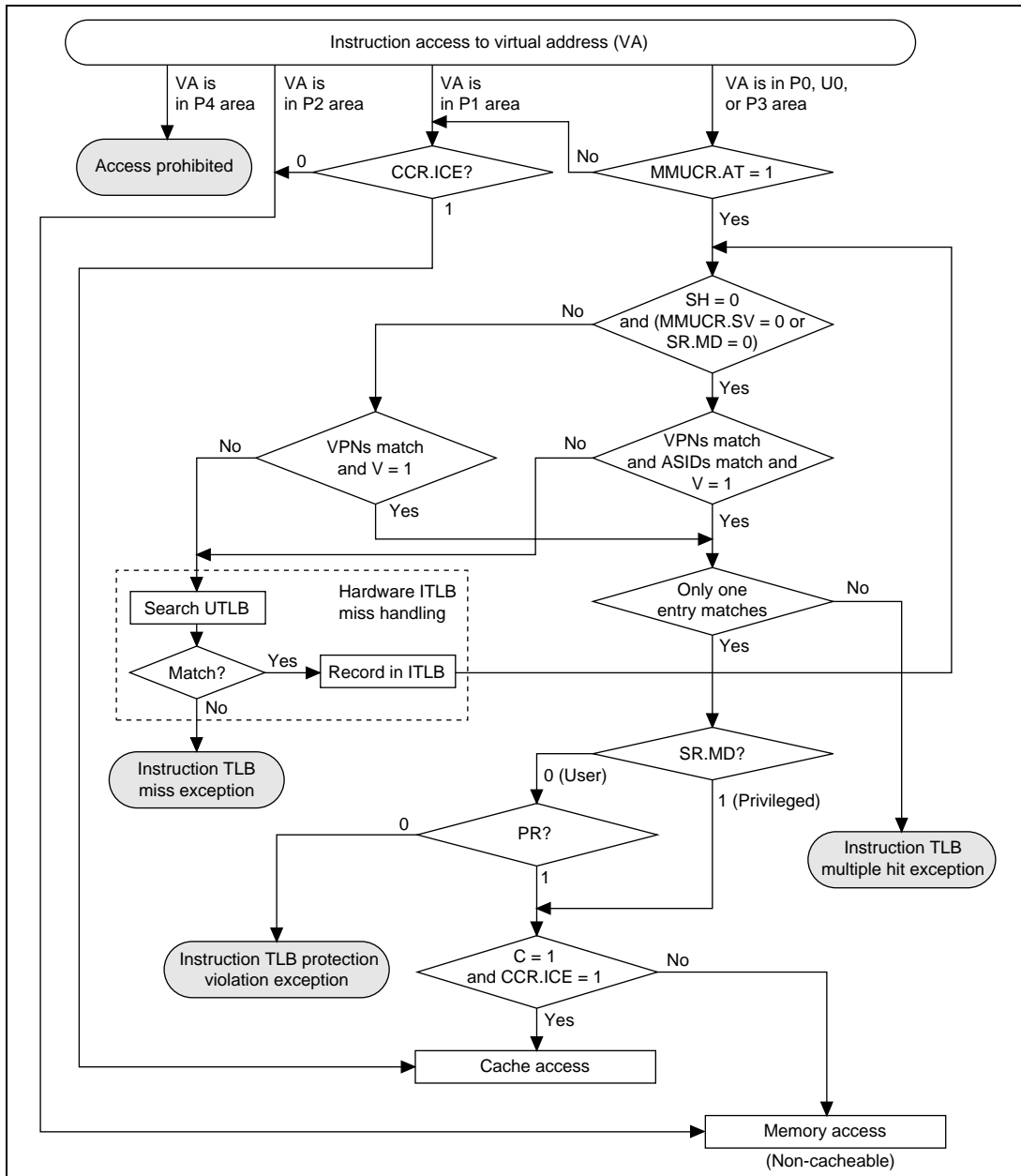

Figure 3.11 Flowchart of Memory Access Using ITLB

## **3.5 MMU Functions**

### **3.5.1 MMU Hardware Management**

The SH7750 supports the following MMU functions.

1. The MMU decodes the virtual address to be accessed by software, and performs address translation by controlling the UTLB/ITLB in accordance with the MMUCR settings.
2. The MMU determines the cache access status on the basis of the page management information read during address translation (C, WT, SA, and TC bits).
3. If address translation cannot be performed normally in a data access or instruction access, the MMU notifies software by means of an MMU exception.
4. If address translation information is not recorded in the ITLB in an instruction access, the MMU searches the UTLB, and if the necessary address translation information is recorded in the UTLB, the MMU copies this information into the ITLB in accordance with MMUCR.LRUI.

### **3.5.2 MMU Software Management**

Software processing for the MMU consists of the following:

1. Setting of MMU-related registers. Some registers are also partially updated by hardware automatically.
2. Recording, deletion, and reading of TLB entries. There are two methods of recording UTLB entries: by using the LDTLB instruction, or by writing directly to the memory-mapped UTLB. ITLB entries can only be recorded by writing directly to the memory-mapped ITLB. For deleting or reading UTLB/ITLB entries, it is possible to access the memory-mapped UTLB/ITLB.
3. MMU exception handling. When an MMU exception occurs, processing is performed based on information set by hardware.

### **3.5.3 MMU Instruction (LDTLB)**

A TLB load instruction (LDTLB) is provided for recording UTLB entries. When an LDTLB instruction is issued, the SH7750 copies the contents of PTEH, PTEL, and PTEA to the UTLB entry indicated by MMUCR.URC. ITLB entries are not updated by the LDTLB instruction, and therefore address translation information purged from the UTLB entry may still remain in the ITLB entry. As the LDTLB instruction changes address translation information, ensure that it is issued by a program in the P1 or P2 area. The operation of the LDTLB instruction is shown in figure 3.12.

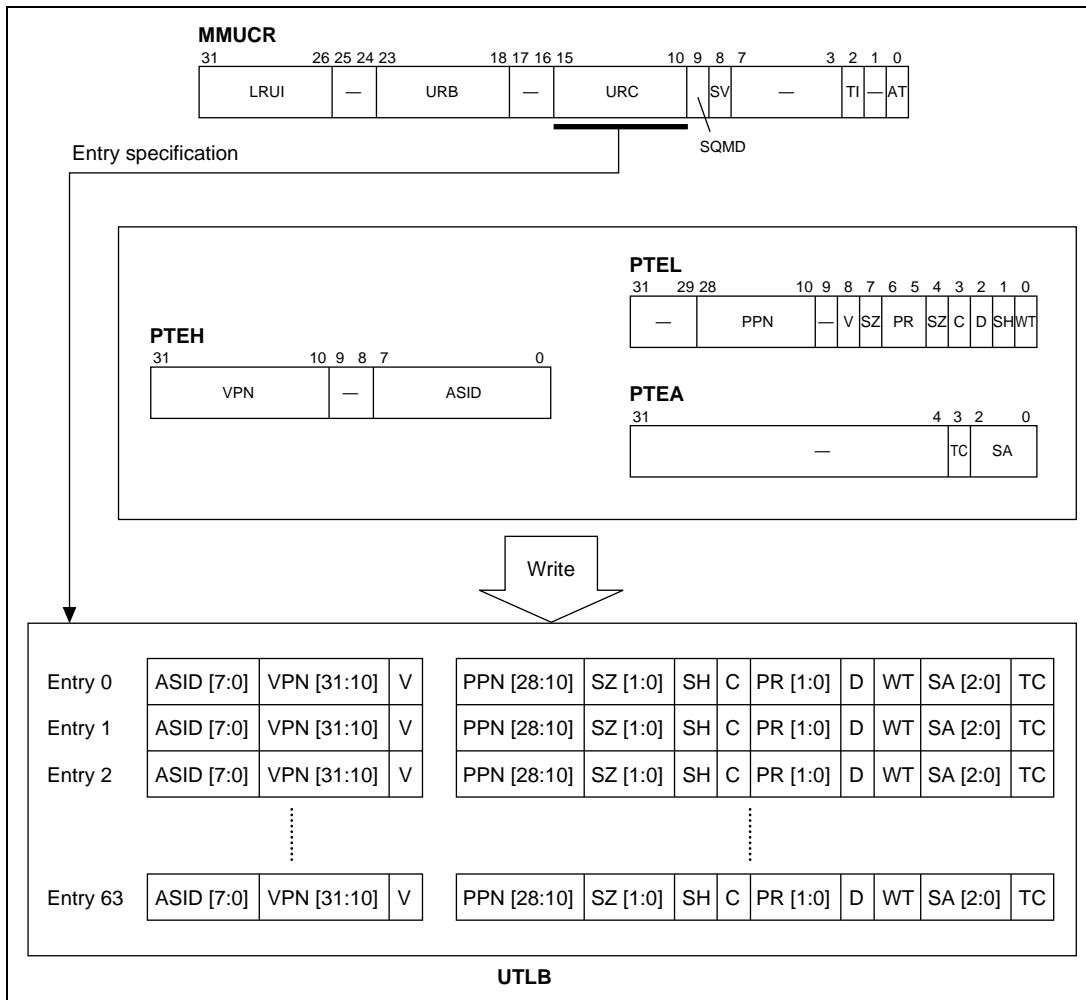

**Figure 3.12 Operation of LDTLB Instruction**

### 3.5.4 Hardware ITLB Miss Handling

In an instruction access, the SH7750 searches the ITLB. If it cannot find the necessary address translation information (i.e. in the event of an ITLB miss), the UTLB is searched by hardware, and if the necessary address translation information is present, it is recorded in the ITLB. This procedure is known as hardware ITLB miss handling. If the necessary address translation information is not found in the UTLB search, an instruction TLB miss exception is generated and processing passes to software.



### 3.5.5 Avoiding Synonym Problems

When 1- or 4-kbyte pages are recorded in TLB entries, a synonym problem may arise. The problem is that, when a number of virtual addresses are mapped onto a single physical address, the same physical address data is recorded in a number of cache entries, and it becomes impossible to guarantee data integrity. This problem does not occur with the instruction TLB or instruction cache. In the SH7750, entry specification is performed using bits [13:5] of the virtual address in order to achieve fast operand cache operation. However, bits [13:10] of the virtual address in the case of a 1-kbyte page, and bits [13:12] of the virtual address in the case of a 4-kbyte page, are subject to address translation. As a result, bits [13:10] of the physical address after translation may differ from bits [13:10] of the virtual address.

Consequently, the following restrictions apply to the recording of address translation information in UTLB entries.

1. When address translation information whereby a number of 1-kbyte page UTLB entries are translated into the same physical address is recorded in the UTLB, ensure that the VPN [13:10] values are the same.
2. When address translation information whereby a number of 4-kbyte page UTLB entries are translated into the same physical address is recorded in the UTLB, ensure that the VPN [13:12] values are the same.
3. Do not use 1-kbyte page UTLB entry physical addresses with UTLB entries of a different page size.
4. Do not use 4-kbyte page UTLB entry physical addresses with UTLB entries of a different page size.

The above restrictions apply only when performing accesses using the cache. When cache index mode is used, VPN [25] is used for the entry address instead of VPN [13], and therefore the above restrictions apply to VPN [25].

Note: When multiple items of address translation information use the same physical memory to provide for future SH Series expansion, ensure that the VPN [20:10] values are the same. Also, do not use the same physical address for address translation information of different page sizes.

## 3.6 MMU Exceptions

There are seven MMU exceptions: the instruction TLB multiple hit exception, instruction TLB miss exception, instruction TLB protection violation exception, data TLB multiple hit exception, data TLB miss exception, data TLB protection violation exception, and initial page write exception. Refer to figures 3.10 and 3.11 for the conditions under which each of these exceptions occurs.

### 3.6.1 Instruction TLB Multiple Hit Exception

An instruction TLB multiple hit exception occurs when more than one ITLB entry matches the virtual address to which an instruction access has been made. If multiple hits occur when the UTLB is searched by hardware in hardware ITLB miss handling, a data TLB multiple hit exception will result.

When an instruction TLB multiple hit exception occurs a reset is executed, and cache coherency is not guaranteed.

**Hardware Processing:** In the event of an instruction TLB multiple hit exception, hardware carries out the following processing:

1. Sets the virtual address at which the exception occurred in TEA.
2. Sets exception code H'140 in EXPEVT.
3. Branches to the reset handling routine (H'A000 0000).

**Software Processing (Reset Routine):** The ITLB entries which caused the multiple hit exception are checked in the reset handling routine. This exception is intended for use in program debugging, and should not normally be generated.

### 3.6.2 Instruction TLB Miss Exception

An instruction TLB miss exception occurs when address translation information for the virtual address to which an instruction access is made is not found in the UTLB entries by the hardware ITLB miss handling procedure. The instruction TLB miss exception processing carried out by hardware and software is shown below. This is the same as the processing for a data TLB miss exception.

**Hardware Processing:** In the event of an instruction TLB miss exception, hardware carries out the following processing:

1. Sets the VPN of the virtual address at which the exception occurred in PTEH.
2. Sets the virtual address at which the exception occurred in TEA.
3. Sets exception code H'040 in EXPEVT.
4. Sets the PC value indicating the address of the instruction at which the exception occurred in SPC. If the exception occurred at a delay slot, sets the PC value indicating the address of the delayed branch instruction in SPC.
5. Sets the SR contents at the time of the exception in SSR. The R15 contents at this time are saved in SGR.
6. Sets the MD bit in SR to 1, and switches to privileged mode.
7. Sets the BL bit in SR to 1, and masks subsequent exception requests.
8. Sets the RB bit in SR to 1.
9. Branches to the address obtained by adding offset H'0000 0400 to the contents of VBR, and starts the instruction TLB miss exception handling routine.

**Software Processing (Instruction TLB Miss Exception Handling Routine):** Software is responsible for searching the external memory page table and assigning the necessary page table entry. Software should carry out the following processing in order to find and assign the necessary page table entry.

1. Write to PTEL the values of the PPN, PR, SZ, C, D, SH, V, and WT bits in the page table entry recorded in the external memory address translation table. If necessary, the values of the SA and TC bits should be written to PTEA.
2. When the entry to be replaced in entry replacement is specified by software, write that value to URC in the MMUCR register. If URC is greater than URB at this time, the value should be changed to an appropriate value after issuing an LDTLB instruction.
3. Execute the LDTLB instruction and write the contents of PTEH, PTEL, and PTEA to the TLB.
4. Finally, execute the exception handling return instruction (RTE), terminate the exception handling routine, and return control to the normal flow. The RTE instruction should be issued at least one instruction after the LDTLB instruction.

### 3.6.3 Instruction TLB Protection Violation Exception

An instruction TLB protection violation exception occurs when, even though an ITLB entry contains address translation information matching the virtual address to which an instruction access is made, the actual access type is not permitted by the access right specified by the PR bit. The instruction TLB protection violation exception processing carried out by hardware and software is shown below.

**Hardware Processing:** In the event of an instruction TLB protection violation exception, hardware carries out the following processing:

1. Sets the VPN of the virtual address at which the exception occurred in PTEH.
2. Sets the virtual address at which the exception occurred in TEA.
3. Sets exception code H'0A0 in EXPEVT.
4. Sets the PC value indicating the address of the instruction at which the exception occurred in SPC. If the exception occurred at a delay slot, sets the PC value indicating the address of the delayed branch instruction in SPC.
5. Sets the SR contents at the time of the exception in SSR. The R15 contents at this time are saved in SGR.
6. Sets the MD bit in SR to 1, and switches to privileged mode.
7. Sets the BL bit in SR to 1, and masks subsequent exception requests.
8. Sets the RB bit in SR to 1.
9. Branches to the address obtained by adding offset H'0000 0100 to the contents of VBR, and starts the instruction TLB protection violation exception handling routine.

**Software Processing (Instruction TLB Protection Violation Exception Handling Routine):** Resolve the instruction TLB protection violation, execute the exception handling return instruction (RTE), terminate the exception handling routine, and return control to the normal flow. The RTE instruction should be issued at least one instruction after the LDTLB instruction.

### 3.6.4 Data TLB Multiple Hit Exception

A data TLB multiple hit exception occurs when more than one UTLB entry matches the virtual address to which a data access has been made. A data TLB multiple hit exception is also generated if multiple hits occur when the UTLB is searched in hardware ITLB miss handling.

When a data TLB multiple hit exception occurs a reset is executed, and cache coherency is not guaranteed. The contents of PPN in the UTLB prior to the exception may also be corrupted.

**Hardware Processing:** In the event of a data TLB multiple hit exception, hardware carries out the following processing:

1. Sets the virtual address at which the exception occurred in TEA.
2. Sets exception code H'140 in EXPEVT.
3. Branches to the reset handling routine (H'A000 0000).

**Software Processing (Reset Routine):** The UTLB entries which caused the multiple hit exception are checked in the reset handling routine. This exception is intended for use in program debugging, and should not normally be generated.

### 3.6.5 Data TLB Miss Exception

A data TLB miss exception occurs when address translation information for the virtual address to which a data access is made is not found in the UTLB entries. The data TLB miss exception processing carried out by hardware and software is shown below.

**Hardware Processing:** In the event of a data TLB miss exception, hardware carries out the following processing:

1. Sets the VPN of the virtual address at which the exception occurred in PTEH.
2. Sets the virtual address at which the exception occurred in TEA.
3. Sets exception code H'040 in the case of a read, or H'060 in the case of a write, in EXPEVT (OCBP, OCBWB: read; OCBI, MOVCA.L: write).
4. Sets the PC value indicating the address of the instruction at which the exception occurred in SPC. If the exception occurred at a delay slot, sets the PC value indicating the address of the delayed branch instruction in SPC.
5. Sets the SR contents at the time of the exception in SSR. The R15 contents at this time are saved in SGR.
6. Sets the MD bit in SR to 1, and switches to privileged mode.
7. Sets the BL bit in SR to 1, and masks subsequent exception requests.
8. Sets the RB bit in SR to 1.
9. Branches to the address obtained by adding offset H'0000 0400 to the contents of VBR, and starts the data TLB miss exception handling routine.

**Software Processing (Data TLB Miss Exception Handling Routine):** Software is responsible for searching the external memory page table and assigning the necessary page table entry. Software should carry out the following processing in order to find and assign the necessary page table entry.

1. Write to PTEL the values of the PPN, PR, SZ, C, D, SH, V, and WT bits in the page table entry recorded in the external memory address translation table. If necessary, the values of the SA and TC bits should be written to PTEA.
2. When the entry to be replaced in entry replacement is specified by software, write that value to URC in the MMUCR register. If URC is greater than URB at this time, the value should be changed to an appropriate value after issuing an LDTLB instruction.
3. Execute the LDTLB instruction and write the contents of PTEH, PTEL, and PTEA to the UTLB.
4. Finally, execute the exception handling return instruction (RTE), terminate the exception handling routine, and return control to the normal flow. The RTE instruction should be issued at least one instruction after the LDTLB instruction.

### 3.6.6 Data TLB Protection Violation Exception

A data TLB protection violation exception occurs when, even though a UTLB entry contains address translation information matching the virtual address to which a data access is made, the actual access type is not permitted by the access right specified by the PR bit. The data TLB protection violation exception processing carried out by hardware and software is shown below.

**Hardware Processing:** In the event of a data TLB protection violation exception, hardware carries out the following processing:

1. Sets the VPN of the virtual address at which the exception occurred in PTEH.
2. Sets the virtual address at which the exception occurred in TEA.
3. Sets exception code H'0A0 in the case of a read, or H'0C0 in the case of a write, in EXPEVT (OCBP, OCBWB: read; OCBI, MOVCA.L: write).
4. Sets the PC value indicating the address of the instruction at which the exception occurred in SPC. If the exception occurred at a delay slot, sets the PC value indicating the address of the delayed branch instruction in SPC.
5. Sets the SR contents at the time of the exception in SSR. The R15 contents at this time are saved in SGR.
6. Sets the MD bit in SR to 1, and switches to privileged mode.
7. Sets the BL bit in SR to 1, and masks subsequent exception requests.
8. Sets the RB bit in SR to 1.
9. Branches to the address obtained by adding offset H'0000 0100 to the contents of VBR, and starts the data TLB protection violation exception handling routine.

**Software Processing (Data TLB Protection Violation Exception Handling Routine):** Resolve the data TLB protection violation, execute the exception handling return instruction (RTE), terminate the exception handling routine, and return control to the normal flow. The RTE instruction should be issued at least one instruction after the LDTLB instruction.

### 3.6.7 Initial Page Write Exception

An initial page write exception occurs when the D bit is 0 even though a UTLB entry contains address translation information matching the virtual address to which a data access (write) is made, and the access is permitted. The initial page write exception processing carried out by hardware and software is shown below.

**Hardware Processing:** In the event of an initial page write exception, hardware carries out the following processing:

1. Sets the VPN of the virtual address at which the exception occurred in PTEH.
2. Sets the virtual address at which the exception occurred in TEA.
3. Sets exception code H'080 in EXPEVT.
4. Sets the PC value indicating the address of the instruction at which the exception occurred in SPC. If the exception occurred at a delay slot, sets the PC value indicating the address of the delayed branch instruction in SPC.
5. Sets the SR contents at the time of the exception in SSR. The R15 contents at this time are saved in SGR.
6. Sets the MD bit in SR to 1, and switches to privileged mode.
7. Sets the BL bit in SR to 1, and masks subsequent exception requests.
8. Sets the RB bit in SR to 1.
9. Branches to the address obtained by adding offset H'0000 0100 to the contents of VBR, and starts the initial page write exception handling routine.

**Software Processing (Initial Page Write Exception Handling Routine):** The following processing should be carried out as the responsibility of software:

1. Retrieve the necessary page table entry from external memory.
2. Write 1 to the D bit in the external memory page table entry.
3. Write to PTEL the values of the PPN, PR, SZ, C, D, WT, SH, and V bits in the page table entry recorded in external memory. If necessary, the values of the SA and TC bits should be written to PTEA.
4. When the entry to be replaced in entry replacement is specified by software, write that value to URC in the MMUCR register. If URC is greater than URB at this time, the value should be changed to an appropriate value after issuing an LDTLB instruction.
5. Execute the LDTLB instruction and write the contents of PTEH, PTEL, and PTEA to the UTLB.
6. Finally, execute the exception handling return instruction (RTE), terminate the exception handling routine, and return control to the normal flow. The RTE instruction should be issued at least one instruction after the LDTLB instruction.

### **3.7 Memory-Mapped TLB Configuration**

To enable the ITLB and UTLB to be managed by software, their contents can be read and written by a P2 area program with a MOV instruction in privileged mode. Operation is not guaranteed if access is made from a program in another area. A branch to an area other than the P2 area should be made at least 8 instructions after this MOV instruction. The ITLB and UTLB are allocated to the P4 area in physical memory space. VPN, V, and ASID in the ITLB can be accessed as an address array, PPN, V, SZ, PR, C, and SH as data array 1, and SA and TC as data array 2. VPN, D, V, and ASID in the UTLB can be accessed as an address array, PPN, V, SZ, PR, C, D, WT, and SH as data array 1, and SA and TC as data array 2. V and D can be accessed from both the address array side and the data array side. Only longword access is possible. Instruction fetches cannot be performed in these areas. For reserved bits, a write value of 0 should be specified; their read value is undefined.



### 3.7.1 ITLB Address Array

The ITLB address array is allocated to addresses H'F200 0000 to H'F2FF FFFF in the P4 area. An address array access requires a 32-bit address field specification (when reading or writing) and a 32-bit data field specification (when writing). Information for selecting the entry to be accessed is specified in the address field, and VPN, V, and ASID to be written to the address array are specified in the data field.

In the address field, bits [31:24] have the value H'F2 indicating the ITLB address array, and the entry is selected by bits [9:8]. As longword access is used, 0 should be specified for address field bits [1:0].

In the data field, VPN is indicated by bits [31:10], V by bit [8], and ASID by bits [7:0].

The following two kinds of operation can be used on the ITLB address array:

1. ITLB address array read  
 VPN, V, and ASID are read into the data field from the ITLB entry corresponding to the entry set in the address field.
2. ITLB address array write  
 VPN, V, and ASID specified in the data field are written to the ITLB entry corresponding to the entry set in the address field.

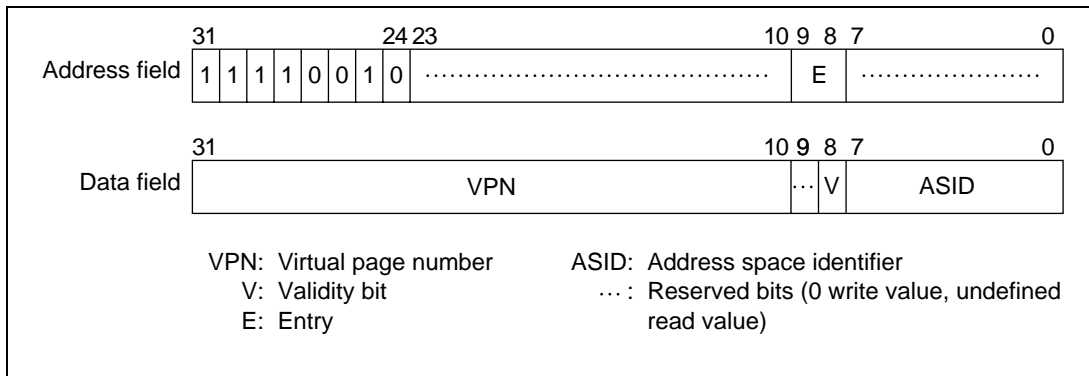

**Figure 3.13 Memory-Mapped ITLB Address Array**

### 3.7.2 ITLB Data Array 1

ITLB data array 1 is allocated to addresses H'F300 0000 to H'F37F FFFF in the P4 area. A data array access requires a 32-bit address field specification (when reading or writing) and a 32-bit data field specification (when writing). Information for selecting the entry to be accessed is specified in the address field, and PPN, V, SZ, PR, C, and SH to be written to the data array are specified in the data field.

In the address field, bits [31:23] have the value H'F30 indicating ITLB data array 1, and the entry is selected by bits [9:8].

In the data field, PPN is indicated by bits [28:10], V by bit [8], SZ by bits [7] and [4], PR by bit [6], C by bit [3], and SH by bit [1].

The following two kinds of operation can be used on ITLB data array 1:

1. ITLB data array 1 read  
PPN, V, SZ, PR, C, and SH are read into the data field from the ITLB entry corresponding to the entry set in the address field.
2. ITLB data array 1 write  
PPN, V, SZ, PR, C, and SH specified in the data field are written to the ITLB entry corresponding to the entry set in the address field.

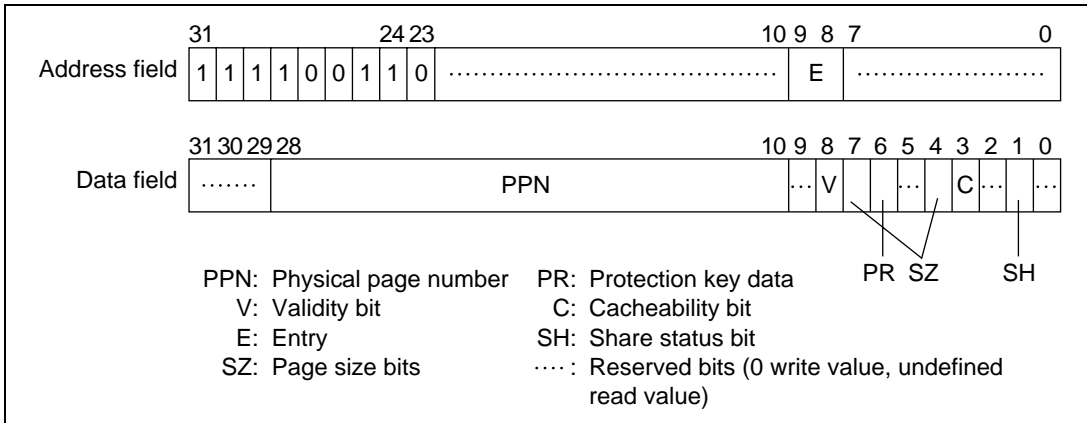

**Figure 3.14 Memory-Mapped ITLB Data Array 1**

### 3.7.3 ITLB Data Array 2

ITLB data array 2 is allocated to addresses H'F380 0000 to H'F3FF FFFF in the P4 area. A data array access requires a 32-bit address field specification (when reading or writing) and a 32-bit data field specification (when writing). Information for selecting the entry to be accessed is specified in the address field, and SA and TC to be written to data array 2 are specified in the data field.

In the address field, bits [31:23] have the value H'F38 indicating ITLB data array 2, and the entry is selected by bits [9:8].

In the data field, SA is indicated by bits [2:0], and TC by bit [3].

The following two kinds of operation can be used on ITLB data array 2:

1. ITLB data array 2 read  
SA and TC are read into the data field from the ITLB entry corresponding to the entry set in the address field.
2. ITLB data array 2 write  
SA and TC specified in the data field are written to the ITLB entry corresponding to the entry set in the address field.

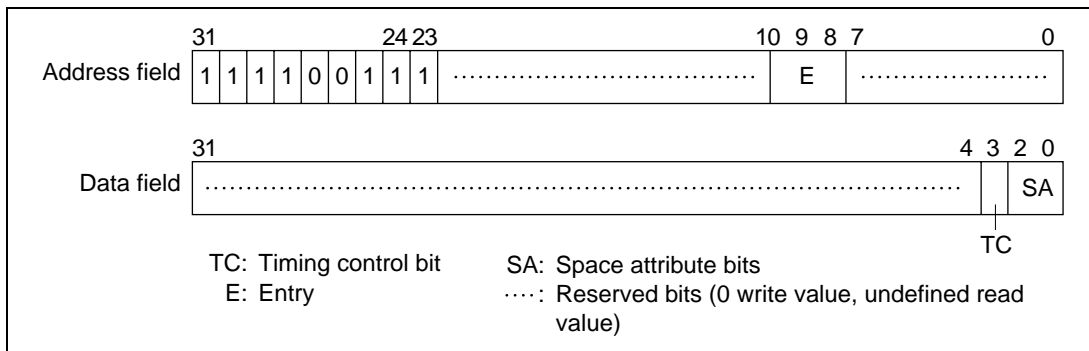

**Figure 3.15 Memory-Mapped ITLB Data Array 2**

### 3.7.4 UTLB Address Array

The UTLB address array is allocated to addresses H'F600 0000 to H'F6FF FFFF in the P4 area. An address array access requires a 32-bit address field specification (when reading or writing) and a 32-bit data field specification (when writing). Information for selecting the entry to be accessed is specified in the address field, and VPN, D, V, and ASID to be written to the address array are specified in the data field.

In the address field, bits [31:24] have the value H'F6 indicating the UTLB address array, and the entry is selected by bits [13:8]. The address array bit [7] association bit (A bit) specifies whether or not address comparison is performed when writing to the UTLB address array.

In the data field, VPN is indicated by bits [31:10], D by bit [9], V by bit [8], and ASID by bits [7:0].

The following three kinds of operation can be used on the UTLB address array:

1. UTLB address array read

VPN, D, V, and ASID are read into the data field from the UTLB entry corresponding to the entry set in the address field. In a read, associative operation is not performed regardless of whether the association bit specified in the address field is 1 or 0.

2. UTLB address array write (non-associative)

VPN, D, V, and ASID specified in the data field are written to the UTLB entry corresponding to the entry set in the address field. The A bit in the address field should be cleared to 0.

3. UTLB address array write (associative)

When a write is performed with the A bit in the address field set to 1, comparison of all the UTLB entries is carried out using the VPN specified in the data field and PTEH.ASID. The usual address comparison rules are followed, but if a UTLB miss occurs, the result is no operation, and an exception is not generated. If the comparison identifies a UTLB entry corresponding to the VPN specified in the data field, D and V specified in the data field are written to that entry. If there is more than one matching entry, a data TLB multiple hit exception results. This associative operation is simultaneously carried out on the ITLB, and if a matching entry is found in the ITLB, V is written to that entry. Even if the UTLB comparison results in no operation, a write to the ITLB side only is performed as long as there is an ITLB match. If there is a match in both the UTLB and ITLB, the UTLB information is also written to the ITLB.

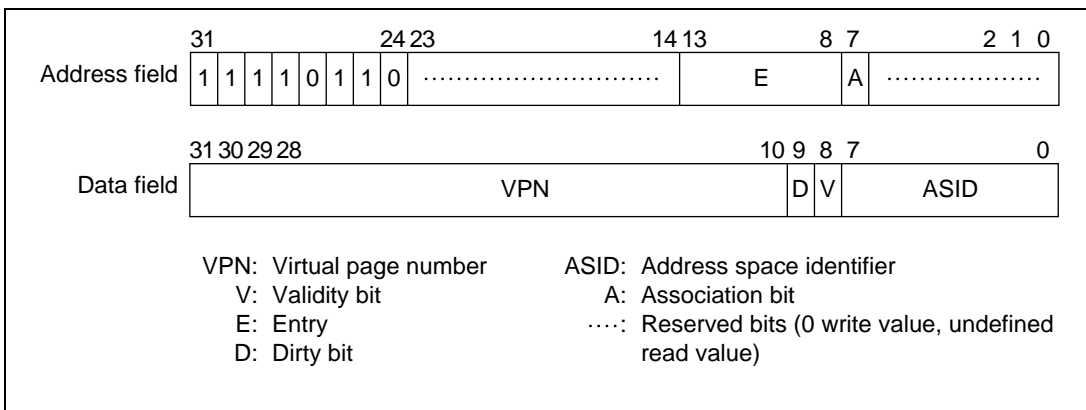

**Figure 3.16 Memory-Mapped UTLB Address Array**

### 3.7.5 UTLB Data Array 1

UTLB data array 1 is allocated to addresses H'F700 0000 to H'F77F FFFF in the P4 area. A data array access requires a 32-bit address field specification (when reading or writing) and a 32-bit data field specification (when writing). Information for selecting the entry to be accessed is specified in the address field, and PPN, V, SZ, PR, C, D, SH, and WT to be written to the data array are specified in the data field.

In the address field, bits [31:23] have the value H'F70 indicating UTLB data array 1, and the entry is selected by bits [13:8].

In the data field, PPN is indicated by bits [28:10], V by bit [8], SZ by bits [7] and [4], PR by bits [6:5], C by bit [3], D by bit [2], SH by bit [1], and WT by bit [0].

The following two kinds of operation can be used on UTLB data array 1:

1. UTLB data array 1 read  
PPN, V, SZ, PR, C, D, SH, and WT are read into the data field from the UTLB entry corresponding to the entry set in the address field.
2. UTLB data array 1 write  
PPN, V, SZ, PR, C, D, SH, and WT specified in the data field are written to the UTLB entry corresponding to the entry set in the address field.

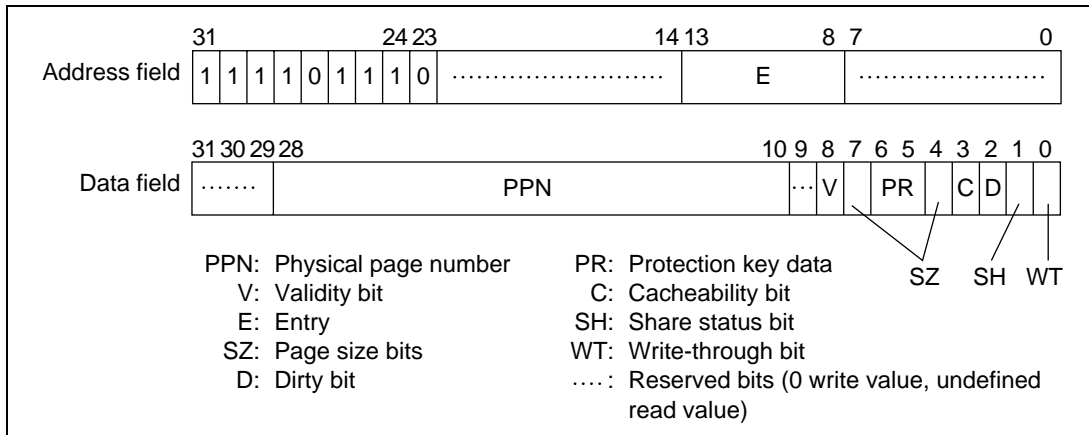

**Figure 3.17 Memory-Mapped UTLB Data Array 1**

### 3.7.6 UTLB Data Array 2

UTLB data array 2 is allocated to addresses H'F780 0000 to H'F7FF FFFF in the P4 area. A data array access requires a 32-bit address field specification (when reading or writing) and a 32-bit data field specification (when writing). Information for selecting the entry to be accessed is specified in the address field, and SA and TC to be written to data array 2 are specified in the data field.

In the address field, bits [31:23] have the value H'F78 indicating UTLB data array 2, and the entry is selected by bits [13:8].

In the data field, TC is indicated by bit [3], and SA by bits [2:0].

The following two kinds of operation can be used on UTLB data array 2:

1. UTLB data array 2 read  
SA and TC are read into the data field from the UTLB entry corresponding to the entry set in the address field.
2. UTLB data array 2 write  
SA and TC specified in the data field are written to the UTLB entry corresponding to the entry set in the address field.

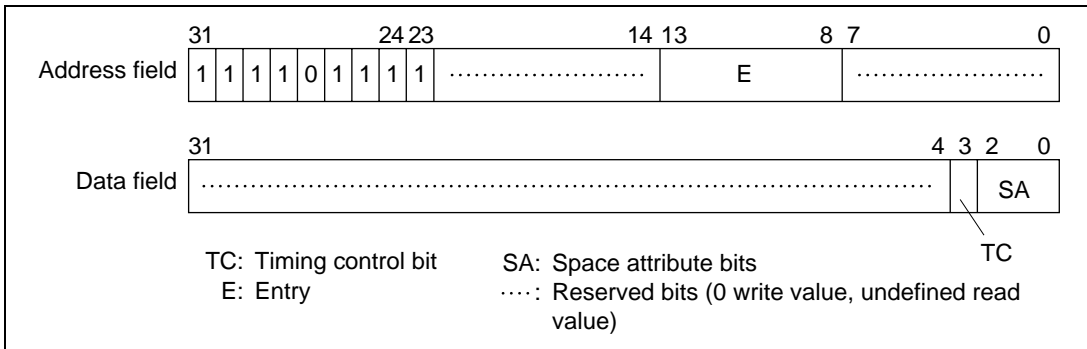

**Figure 3.18 Memory-Mapped UTLB Data Array 2**

## Section 4 Caches

### 4.1 Overview

#### 4.1.1 Features

The SH7750 has an on-chip 8-kbyte instruction cache (IC) for instructions and 16-kbyte operand cache (OC) for data. Half of the memory of the operand cache (8 kbytes) can also be used as on-chip RAM. The features of these caches are summarized in table 4.1.

**Table 4.1 Cache Features**

<b>Item</b>	<b>Instruction Cache</b>	<b>Operand Cache</b>
Capacity	8-kbyte cache	16-kbyte cache or 8-kbyte cache + 8-kbyte RAM
Type	Direct mapping	Direct mapping
Line size	32 bytes	32 bytes
Entries	256	512
Write method		Copy-back/write-through selectable

<b>Item</b>	<b>Store Queues</b>
Capacity	2 × 32 bytes
Addresses	H'E000 0000 to H'E3FF FFFF
Write	Store instruction (1-cycle write)
Write-back	Prefetch instruction
Access right	MMU off: according to MMUCR.SQMD MMU on: according to individual page PR

### 4.1.2 Register Configuration

Table 4.2 shows the cache control registers.

**Table 4.2 Cache Control Registers**

Name	Abbreviation	R/W	Initial Value* <sup>1</sup>	P4 Address* <sup>2</sup>	Area 7 Address* <sup>2</sup>	Access Size
Cache control register	CCR	R/W	H'0000 0000	H'FF00 001C	H'1F00 001C	32
Queue address control register 0	QACR0	R/W	Undefined	H'FF00 0038	H'1F00 0038	32
Queue address control register 1	QACR1	R/W	Undefined	H'FF00 003C	H'1F00 003C	32

- Notes:
1. The initial value is the value after a power-on or manual reset.
  2. This is the address when using the virtual/physical address space P4 area. When making an access from physical address space area 7 using the TLB, the upper 3 bits of the address are ignored.

## 4.2 Register Descriptions

There are three cache and store queue related control registers, as shown in figure 4.1.

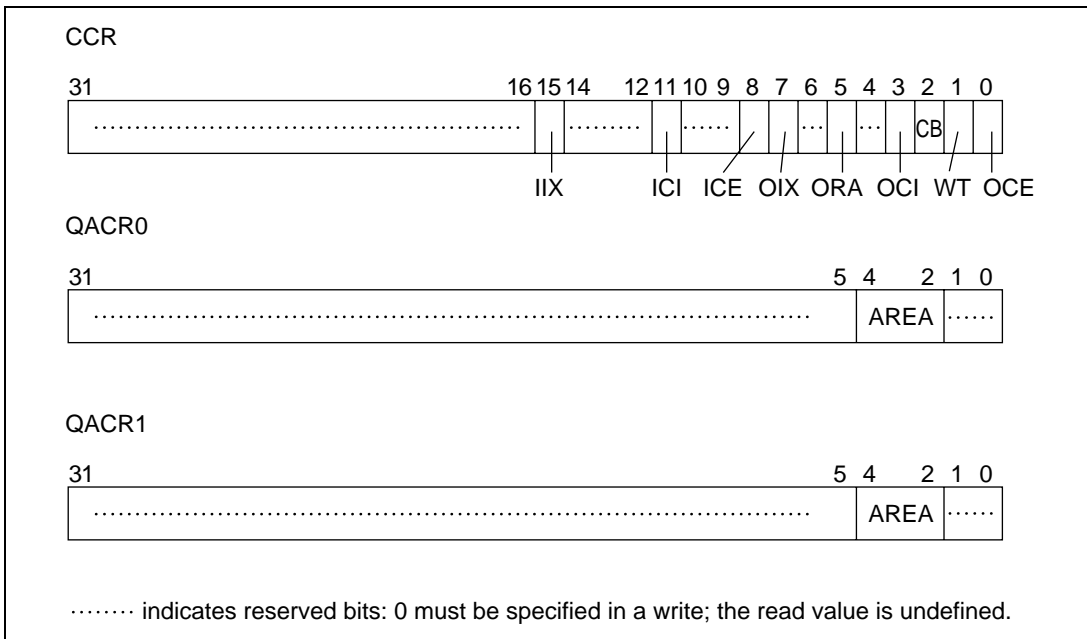

**Figure 4.1 Cache and Store Queue Control Registers**



(1) **Cache Control Register (CCR):** CCR contains the following bits:

IIX: IC index enable  
ICI: IC invalidation  
ICE: IC enable  
OIX: OC index enable  
ORA: OC RAM enable  
OCI: OC invalidation  
CB: Copy-back enable  
WT: Write-through enable  
OCE: OC enable

Longword access to CCR can be performed from H'FF00 001C in the P4 area and H'1F00 001C in area 7. The CCR bits are used for the cache settings described below. Consequently, CCR modifications must only be made by a program in the non-cached P2 area. After CCR is updated, an instruction that performs data access to the P0, P1, P3, or U0 area should be located at least four instructions after the CCR update instruction. Also, a branch instruction to the P0, P1, P3, or U0 area should be located at least eight instructions after the CCR update instruction.

- **IIX: IC index enable bit**
  - 0: Address bits [12:5] used for IC entry selection
  - 1: Address bits [25] and [11:5] used for IC entry selection
- **ICI: IC invalidation bit**

When 1 is written to this bit, the V bits of all IC entries are cleared to 0. This bit always returns 0 when read.
- **ICE: IC enable bit**

Indicates whether or not the IC is to be used. When address translation is performed, the IC cannot be used unless the C bit in the page management information is also 1.

  - 0: IC not used
  - 1: IC used
- **OIX: OC index enable bit**
  - 0: Address bits [13:5] used for OC entry selection
  - 1: Address bits [25] and [12:5] used for OC entry selection
- **ORA: OC RAM enable bit**

When the OC is enabled (OCE = 1), the ORA bit specifies whether the 8 kbytes from entry 128 to entry 255 and from entry 384 to entry 511 of the OC are to be used as RAM. When the OC is not enabled (OCE = 0), the ORA bit should be cleared to 0.

  - 0: 16 kbytes used as cache
  - 1: 8 kbytes used as cache, and 8 kbytes as RAM

- **OCI: OC invalidation bit**  
When 1 is written to this bit, the V and U bits of all OC entries are cleared to 0. This bit always returns 0 when read.
- **CB: Copy-back bit**  
Indicates the P1 area cache write mode.  
0: Write-through mode  
1: Copy-back mode
- **WT: Write-through bit**  
Indicates the P0, U0, and P3 area cache write mode. When address translation is performed, the value of the WT bit in the page management information has priority.  
0: Copy-back mode  
1: Write-through mode
- **OCE: OC enable bit**  
Indicates whether or not the OC is to be used. When address translation is performed, the OC cannot be used unless the C bit in the page management information is also 1.  
0: OC not used  
1: OC used

**(2) Queue Address Control Register 0 (QACR0):** Longword access to QACR0 can be performed from H'FF00 0038 in the P4 area and H'1F00 0038 in area 7. QACR0 specifies the area onto which store queue 0 (SQ0) is mapped when the MMU is off.

**(3) Queue Address Control Register 1 (QACR1):** Longword access to QACR1 can be performed from H'FF00 003C in the P4 area and H'1F00 003C in area 7. QACR1 specifies the area onto which store queue 1 (SQ1) is mapped when the MMU is off.

## 4.3 Operand Cache (OC)

### 4.3.1 Configuration

Figure 4.2 shows the configuration of the operand cache.

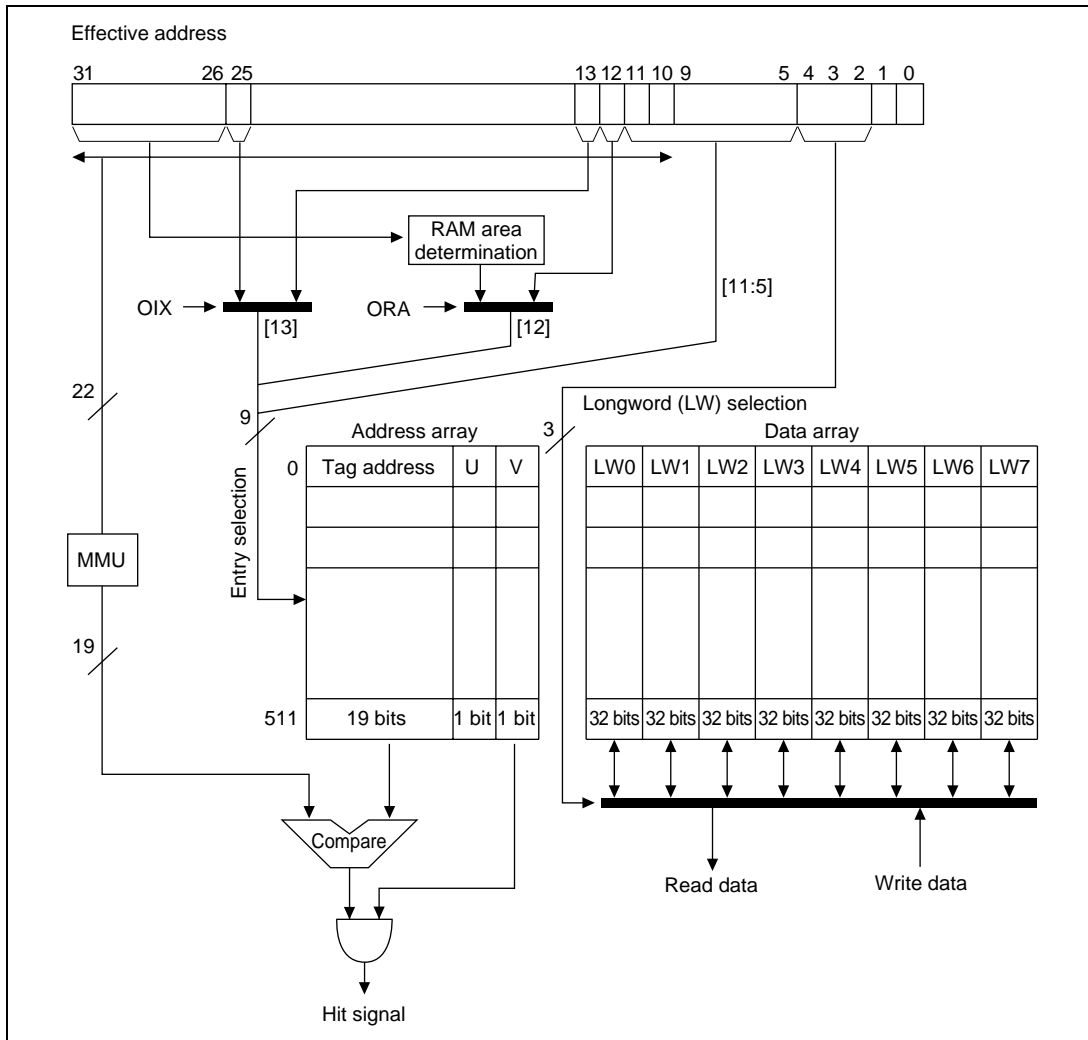

Figure 4.2 Configuration of Operand Cache

The operand cache consists of 512 cache lines, each composed of a 19-bit tag, V bit, U bit, and 32-byte data.

- **Tag**  
Stores the upper 19 bits of the 29-bit external memory address of the data line to be cached. The tag is not initialized by a power-on or manual reset.
- **V bit (validity bit)**  
Indicates that valid data is stored in the cache line. When this bit is 1, the cache line data is valid. The V bit is initialized to 0 by a power-on reset, but retains its value in a manual reset.
- **U bit (dirty bit)**  
The U bit is set to 1 if data is written to the cache line while the cache is being used in copy-back mode. That is, the U bit indicates a mismatch between the data in the cache line and the data in external memory. The U bit is never set to 1 while the cache is being used in write-through mode, unless it is modified by accessing the memory-mapped cache (see section 4.5, Memory-Mapped Cache Configuration). The U bit is initialized to 0 by a power-on reset, but retains its value in a manual reset.
- **Data field**  
The data field holds 32 bytes (256 bits) of data per cache line. The data array is not initialized by a power-on or manual reset.

#### 4.3.2 Read Operation

When the OC is enabled ( $CCR.OCE = 1$ ) and data is read by means of an effective address from a cacheable area, the cache operates as follows:

1. The tag, V bit, and U bit are read from the cache line indexed by effective address bits [13:5].
2. The tag is compared with bits [28:10] of the address resulting from effective address translation by the MMU:
  - If the tag matches and the V bit is 1 → (3a)
  - If the tag matches and the V bit is 0 → (3b)
  - If the tag does not match and the V bit is 0 → (3b)
  - If the tag does not match, the V bit is 1, and the U bit is 0 → (3b)
  - If the tag does not match, the V bit is 1, and the U bit is 1 → (3c)

### 3a. Cache hit

The data indexed by effective address bits [4:0] is read from the data field of the cache line indexed by effective address bits [13:5] in accordance with the access size (quadword/longword/word/byte).

### 3b. Cache miss (no write-back)

Data is read into the cache line from the external memory space corresponding to the effective address. Data reading is performed, using the wraparound method, in order from the longword data corresponding to the effective address, and when the corresponding data arrives in the cache, the read data is returned to the CPU. While the remaining one cache line of data is being read, the CPU can execute the next processing. When reading of one line of data is completed, the tag corresponding to the effective address is recorded in the cache, and 1 is written to the V bit.

### 3c. Cache miss (with write-back)

The tag and data field of the cache line indexed by effective address bits [13:5] are saved in the write-back buffer. Then data is read into the cache line from the external memory space corresponding to the effective address. Data reading is performed, using the wraparound method, in order from the longword data corresponding to the effective address, and when the corresponding data arrives in the cache, the read data is returned to the CPU. While the remaining one cache line of data is being read, the CPU can execute the next processing. When reading of one line of data is completed, the tag corresponding to the effective address is recorded in the cache, 1 is written to the V bit, and 0 to the U bit. The data in the write-back buffer is then written back to external memory.

## 4.3.3 Write Operation

When the OC is enabled (CCR.OCE = 1) and data is written by means of an effective address to a cacheable area, the cache operates as follows:

1. The tag, V bit, and U bit are read from the cache line indexed by effective address bits [13:5].
2. The tag is compared with bits [28:10] of the address resulting from effective address translation by the MMU:

	Copy-back	Write-through
• If the tag matches and the V bit is 1	→ (3a)	→ (3b)
• If the tag matches and the V bit is 0	→ (3c)	→ (3d)
• If the tag does not match and the V bit is 0	→ (3c)	→ (3d)
• If the tag does not match, the V bit is 1, and the U bit is 0	→ (3c)	→ (3d)
• If the tag does not match, the V bit is 1, and the U bit is 1	→ (3e)	→ (3d)

3a. Cache hit (copy-back)

A data write in accordance with the access size (quadword/longword/word/byte) is performed for the data indexed by bits [4:0] of the effective address of the data field of the cache line indexed by effective address bits [13:5]. Then 1 is set in the U bit.

3b. Cache hit (write-through)

A data write in accordance with the access size (quadword/longword/word/byte) is performed for the data indexed by bits [4:0] of the effective address of the data field of the cache line indexed by effective address bits [13:5]. A write is also performed to the corresponding external memory using the specified access size.

3c. Cache miss (no copy-back/write-back)

A data write in accordance with the access size (quadword/longword/word/byte) is performed for the data indexed by bits [4:0] of the effective address of the data field of the cache line indexed by effective address bits [13:5]. Then, data is read into the cache line from the external memory space corresponding to the effective address. Data reading is performed, using the wraparound method, in order from the longword data corresponding to the effective address, and one cache line of data is read excluding the written data. During this time, the CPU can execute the next processing. When reading of one line of data is completed, the tag corresponding to the effective address is recorded in the cache, and 1 is written to the V bit and U bit.

3d. Cache miss (write-through)

A write of the specified access size is performed to the external memory corresponding to the effective address. In this case, a write to cache is not performed.

3e. Cache miss (with copy-back/write-back)

The tag and data field of the cache line indexed by effective address bits [13:5] are first saved in the write-back buffer, and then a data write in accordance with the access size (quadword/longword/word/byte) is performed for the data indexed by bits [4:0] of the effective address of the data field of the cache line indexed by effective address bits [13:5]. Then, data is read into the cache line from the external memory space corresponding to the effective address. Data reading is performed, using the wraparound method, in order from the longword data corresponding to the effective address, and one cache line of data is read excluding the written data. During this time, the CPU can execute the next processing. When reading of one line of data is completed, the tag corresponding to the effective address is recorded in the cache, and 1 is written to the V bit and U bit. The data in the write-back buffer is then written back to external memory.

#### 4.3.4 Write-Back Buffer

In order to give priority to data reads to the cache and improve performance, the SH7750 has a write-back buffer which holds the relevant cache entry when it becomes necessary to purge a dirty cache entry into external memory as the result of a cache miss. The write-back buffer contains one cache line of data and the physical address of the purge destination.

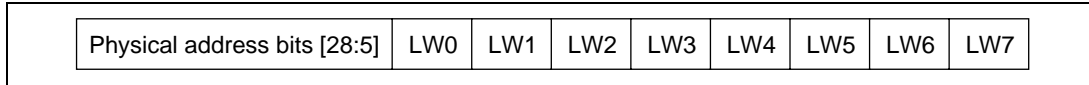

Figure 4.3 Configuration of Write-Back Buffer

#### 4.3.5 Write-Through Buffer

The SH7750 has a 64-bit buffer for holding write data when writing data in write-through mode or writing to a non-cacheable area. This allows the CPU to proceed to the next operation as soon as the write to the write-through buffer is completed, without waiting for completion of the write to external memory.

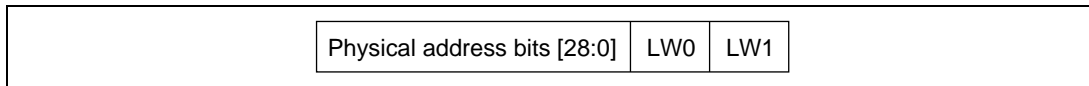

Figure 4.4 Configuration of Write-Through Buffer

#### 4.3.6 RAM Mode

Setting CCR.ORA to 1 enables 8 kbytes of the operand cache to be used as RAM. The operand cache entries used as RAM are entries 128 to 255 and 384 to 511. Other entries can still be used as cache. RAM can be accessed using addresses H'7C00 0000 to H'7FFF FFFF. Byte-, word-, longword-, and quadword-size data reads and writes can be performed in the operand cache RAM area. Instruction fetches cannot be performed in this area.

An example of RAM use is shown below. Here, the 4 kbytes comprising OC entries 128 to 256 are designated as RAM area 1, and the 4 kbytes comprising OC entries 384 to 511 as RAM area 2.

- When OC index mode is off (CCR.OIX = 0)
  - H'7C00 0000 to H'7C00 0FFF (4 kB): Corresponds to RAM area 1
  - H'7C00 1000 to H'7C00 1FFF (4 kB): Corresponds to RAM area 1
  - H'7C00 2000 to H'7C00 2FFF (4 kB): Corresponds to RAM area 2
  - H'7C00 3000 to H'7C00 3FFF (4 kB): Corresponds to RAM area 2
  - H'7C00 4000 to H'7C00 4FFF (4 kB): Corresponds to RAM area 1
  - : : :

RAM areas 1 and 2 then repeat every 8 kbytes up to H'7FFF FFFF.  
Thus, to secure a continuous 8-kbyte RAM area, the area from H'7C00 1000 to H'7C00 2FFF can be used, for example.

- When OC index mode is on (CCR.OIX = 1)
  - H'7C00 0000 to H'7C00 0FFF (4 kB): Corresponds to RAM area 1
  - H'7C00 1000 to H'7C00 1FFF (4 kB): Corresponds to RAM area 1
  - H'7C00 2000 to H'7C00 2FFF (4 kB): Corresponds to RAM area 1
  - : : :
  - H'7DFF F000 to H'7DFF FFFF (4 kB): Corresponds to RAM area 1
  - H'7E00 0000 to H'7E00 0FFF (4 kB): Corresponds to RAM area 2
  - H'7E00 1000 to H'7E00 1FFF (4 kB): Corresponds to RAM area 2
  - : : :
  - H'7FFF F000 to H'7FFF FFFF (4 kB): Corresponds to RAM area 2

As the distinction between RAM areas 1 and 2 is indicated by address bit [25], the area from H'7DFF F000 to H'7E00 0FFF should be used to secure a continuous 8-kbyte RAM area.

#### 4.3.7 OC Index Mode

Setting CCR.OIX to 1 enables OC indexing to be performed using bit [25] of the effective address. This is called OC index mode. In normal mode, with CCR.OIX cleared to 0, OC indexing is performed using bits [13:5] of the effective address; therefore, when 16 kbytes or more of consecutive data is handled, the OC is fully used by this data. This results in frequent cache misses. Using index mode allows the OC to be handled as two 8-kbyte areas by means of effective address bit [25], providing efficient use of the cache.



#### 4.3.8 Coherency between Cache and External Memory

Coherency between cache and external memory should be assured by software. In the SH7750, the following four new instructions are supported for cache operations. For details of these instructions, see section 10, Instruction Descriptions.

Invalidate instruction:	OCBI @Rn	Cache invalidation (no write-back)
Purge instruction:	OCBP @Rn	Cache invalidation (with write-back)
Write-back instruction:	OCBWB @Rn	Cache write-back
Allocate instruction:	MOVCA.L R0,@Rn	Cache allocation

#### 4.3.9 Prefetch Operation

The SH7750 supports a prefetch instruction to reduce the cache fill penalty incurred as the result of a cache miss. If it is known that a cache miss will result from a read or write operation, it is possible to fill the cache with data beforehand by means of the prefetch instruction to prevent a cache miss due to the read or write operation, and so improve software performance. If a prefetch instruction is executed for data already held in the cache, or if the prefetch address results in a UTLB miss or a protection violation, the result is no operation, and an exception is not generated. For details of the prefetch instruction, see section 10.74, PREF.

Prefetch instruction:	PREF @Rn
-----------------------	----------

## 4.4 Instruction Cache (IC)

### 4.4.1 Configuration

Figure 4.5 shows the configuration of the instruction cache.

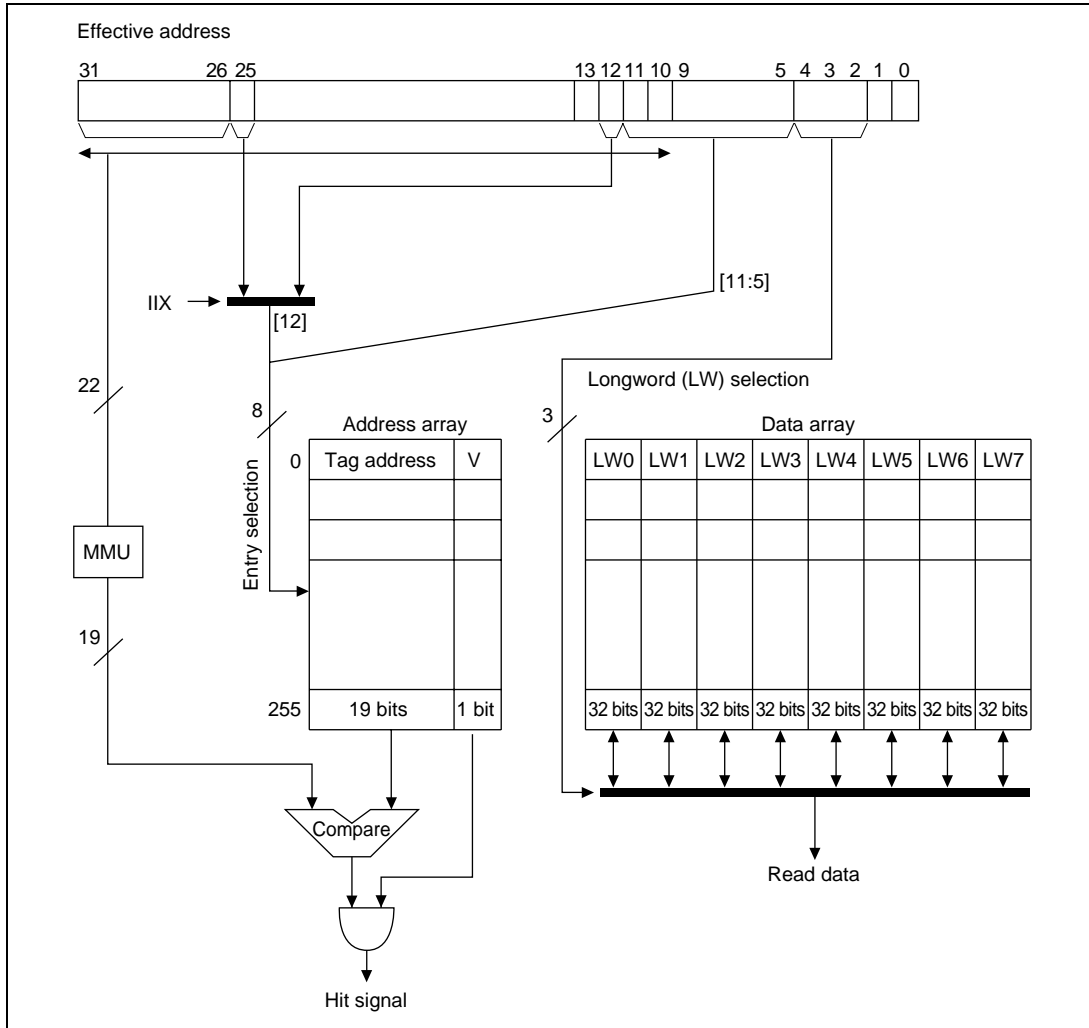

**Figure 4.5 Configuration of Instruction Cache**

The instruction cache consists of 256 cache lines, each composed of a 19-bit tag, V bit, and 32-byte data (16 instructions).

- Tag  
Stores the upper 19 bits of the 29-bit external memory address of the data line to be cached. The tag is not initialized by a power-on or manual reset.
- V bit (validity bit)  
Indicates that valid data is stored in the cache line. When this bit is 1, the cache line data is valid. The V bit is initialized to 0 by a power-on reset, but retains its value in a manual reset.
- Data array  
The data field holds 32 bytes (256 bits) of data per cache line. The data array is not initialized by a power-on or manual reset.

#### 4.4.2 Read Operation

When the IC is enabled ( $CCR.ICE = 1$ ) and instruction fetches are performed by means of an effective address from a cacheable area, the instruction cache operates as follows:

1. The tag and V bit are read from the cache line indexed by effective address bits [12:5].
2. The tag is compared with bits [28:10] of the address resulting from effective address translation by the MMU:
  - If the tag matches and the V bit is 1 → (3a)
  - If the tag matches and the V bit is 0 → (3b)
  - If the tag does not match and the V bit is 0 → (3b)
  - If the tag does not match and the V bit is 1 → (3b)

##### 3a. Cache hit

The data indexed by effective address bits [4:2] is read as an instruction from the data field of the cache line indexed by effective address bits [12:5].

##### 3b. Cache miss

Data is read into the cache line from the external memory space corresponding to the effective address. Data reading is performed, using the wraparound method, in order from the longword data corresponding to the effective address, and when the corresponding data arrives in the cache, the read data is returned to the CPU as an instruction. When reading of one line of data is completed, the tag corresponding to the effective address is recorded in the cache, and 1 is written to the V bit.

### 4.4.3 IC Index Mode

Setting CCR.IIX to 1 enables IC indexing to be performed using bit [25] of the effective address. This is called IC index mode. In normal mode, with CCR.IIX cleared to 0, IC indexing is performed using bits [12:5] of the effective address; therefore, when 8 kbytes or more of consecutive program instructions are handled, the IC is fully used by this program. This results in frequent cache misses. Using index mode allows the IC to be handled as two 4-kbyte areas by means of effective address bit [25], providing efficient use of the cache.

## 4.5 Memory-Mapped Cache Configuration

To enable the IC and OC to be managed by software, their contents can be read and written by a P2 area program with a MOV instruction in privileged mode. Operation is not guaranteed if access is made from a program in another area. In this case, a branch to the P0, U0, P1, or P3 area should be made at least 8 instructions after this MOV instruction. The IC and OC are allocated to the P4 area in physical memory space. Only data accesses can be used on both the IC address array and data array and the OC address array and data array, and accesses are always longword-size. Instruction fetches cannot be performed in these areas. For reserved bits, a write value of 0 should be specified; their read value is undefined.

### 4.5.1 IC Address Array

The IC address array is allocated to addresses H'F000 0000 to H'FOFF FFFF in the P4 area. An address array access requires a 32-bit address field specification (when reading or writing) and a 32-bit data field specification. The entry to be accessed is specified in the address field, and the write tag and V bit are specified in the data field.

In the address field, bits [31:24] have the value H'F0 indicating the IC address array, and the entry is specified by bits [12:5]. CCR.IIX has no effect on this entry specification. The address array bit [3] association bit (A bit) specifies whether or not association is performed when writing to the IC address array. As only longword access is used, 0 should be specified for address field bits [1:0].

In the data field, the tag is indicated by bits [31:10], and the V bit by bit [0]. As the IC address array tag is 19 bits in length, data field bits [31:29] are not used in the case of a write in which association is not performed. Data field bits [31:29] are used for the virtual address specification only in the case of a write in which association is performed.

The following three kinds of operation can be used on the IC address array:

1. IC address array read

The tag and V bit are read into the data field from the IC entry corresponding to the entry set in the address field. In a read, associative operation is not performed regardless of whether the association bit specified in the address field is 1 or 0.

2. IC address array write (non-associative)

The tag and V bit specified in the data field are written to the IC entry corresponding to the entry set in the address field. The A bit in the address field should be cleared to 0.

3. IC address array write (associative)

When a write is performed with the A bit in the address field set to 1, the tag stored in the entry specified in the address field is compared with the tag specified in the data field. If the MMU is enabled at this time, comparison is performed after the virtual address specified by data field bits [31:10] has been translated to a physical address using the ITLB. If the addresses match and the V bit is 1, the V bit specified in the data field is written into the IC entry. This operation is used to invalidate a specific IC entry. If an ITLB miss occurs during address translation, or the comparison shows a mismatch, no operation results and the write is not performed. If an instruction TLB multiple hit exception occurs during address translation, processing switches to the instruction TLB multiple hit exception handling routine.

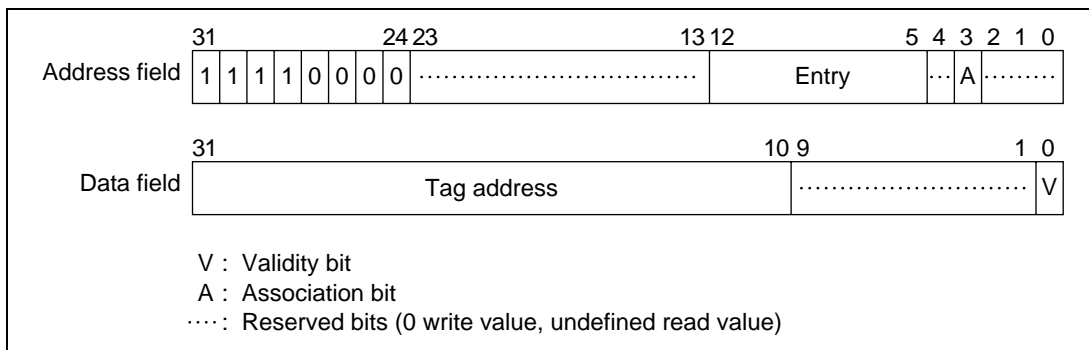

**Figure 4.6 Memory-Mapped IC Address Array**

**4.5.2 IC Data Array**

The IC data array is allocated to addresses H'F100 0000 to H'F1FF FFFF in the P4 area. A data array access requires a 32-bit address field specification (when reading or writing) and a 32-bit data field specification. The entry to be accessed is specified in the address field, and the longword data to be written is specified in the data field.

In the address field, bits [31:24] have the value H'F1 indicating the IC data array, and the entry is specified by bits [12:5]. CCR.IIX has no effect on this entry specification. Address field bits [4:2] are used for the longword data specification in the entry. As only longword access is used, 0 should be specified for address field bits [1:0].

The data field is used for the longword data specification.

The following two kinds of operation can be used on the IC data array:

1. IC data array read

Longword data is read into the data field from the data specified by the longword specification bits in the address field in the IC entry corresponding to the entry set in the address field.

2. IC data array write

The longword data specified in the data field is written for the data specified by the longword specification bits in the address field in the IC entry corresponding to the entry set in the address field.

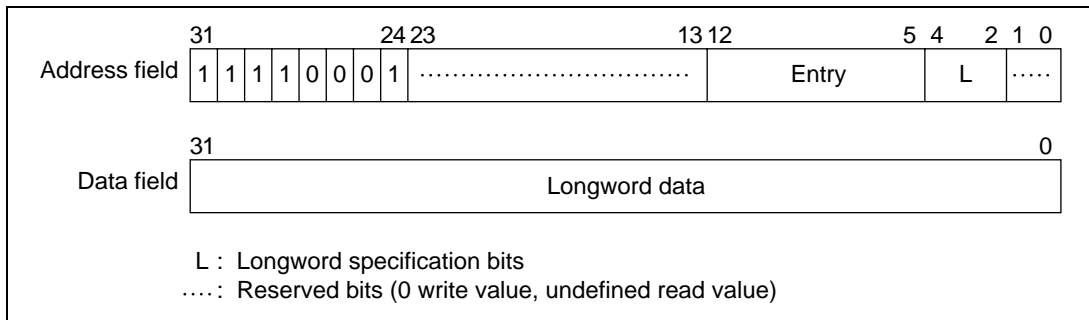

**Figure 4.7 Memory-Mapped IC Data Array**

**4.5.3 OC Address Array**

The OC address array is allocated to addresses H'F400 0000 to H'F4FF FFFF in the P4 area. An address array access requires a 32-bit address field specification (when reading or writing) and a 32-bit data field specification. The entry to be accessed is specified in the address field, and the write tag, U bit, and V bit are specified in the data field.

In the address field, bits [31:24] have the value H'F4 indicating the OC address array, and the entry is specified by bits [13:5]. CCR.OIX and CCR.ORA have no effect on this entry specification. The address array bit [3] association bit (A bit) specifies whether or not association is performed when writing to the OC address array. As only longword access is used, 0 should be specified for address field bits [1:0].

In the data field, the tag is indicated by bits [31:10], the U bit by bit [1], and the V bit by bit [0]. As the OC address array tag is 19 bits in length, data field bits [31:29] are not used in the case of a write in which association is not performed. Data field bits [31:29] are used for the virtual address specification only in the case of a write in which association is performed.

The following three kinds of operation can be used on the OC address array:

1. OC address array read

The tag, U bit, and V bit are read into the data field from the OC entry corresponding to the entry set in the address field. In a read, associative operation is not performed regardless of whether the association bit specified in the address field is 1 or 0.

2. OC address array write (non-associative)

The tag, U bit, and V bit specified in the data field are written to the OC entry corresponding to the entry set in the address field. The A bit in the address field should be cleared to 0.

When a write is performed to a cache line for which the U bit and V bit are both 1, after write-back of that cache line, the tag, U bit, and V bit specified in the data field are written.

3. OC address array write (associative)

When a write is performed with the A bit in the address field set to 1, the tag stored in the entry specified in the address field is compared with the tag specified in the data field. If the MMU is enabled at this time, comparison is performed after the virtual address specified by data field bits [31:10] has been translated to a physical address using the UTLB. If the addresses match and the V bit is 1, the U bit and V bit specified in the data field are written into the OC entry. This operation is used to invalidate a specific OC entry. If the OC entry U bit is 1, and 0 is written to the V bit or to the U bit, write-back is performed. If an UTLB miss occurs during address translation, or the comparison shows a mismatch, no operation results and the write is not performed. If a data TLB multiple hit exception occurs during address translation, processing switches to the data TLB multiple hit exception handling routine.

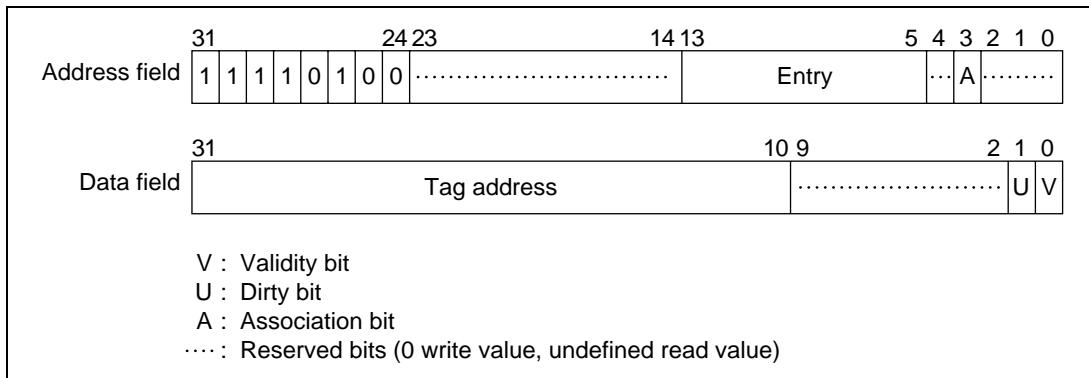

**Figure 4.8 Memory-Mapped OC Address Array**

#### 4.5.4 OC Data Array

The OC data array is allocated to addresses H'F500 0000 to H'F5FF FFFF in the P4 area. A data array access requires a 32-bit address field specification (when reading or writing) and a 32-bit data field specification. The entry to be accessed is specified in the address field, and the longword data to be written is specified in the data field.

In the address field, bits [31:24] have the value H'F5 indicating the OC data array, and the entry is specified by bits [13:5]. CCR.OIX and CCR.ORA have no effect on this entry specification. Address field bits [4:2] are used for the longword data specification in the entry. As only longword access is used, 0 should be specified for address field bits [1:0].

The data field is used for the longword data specification.

The following two kinds of operation can be used on the OC data array:

1. OC data array read

Longword data is read into the data field from the data specified by the longword specification bits in the address field in the OC entry corresponding to the entry set in the address field.

2. OC data array write

The longword data specified in the data field is written for the data specified by the longword specification bits in the address field in the OC entry corresponding the entry set in the address field. This write does not set the U bit to 1 on the address array side.

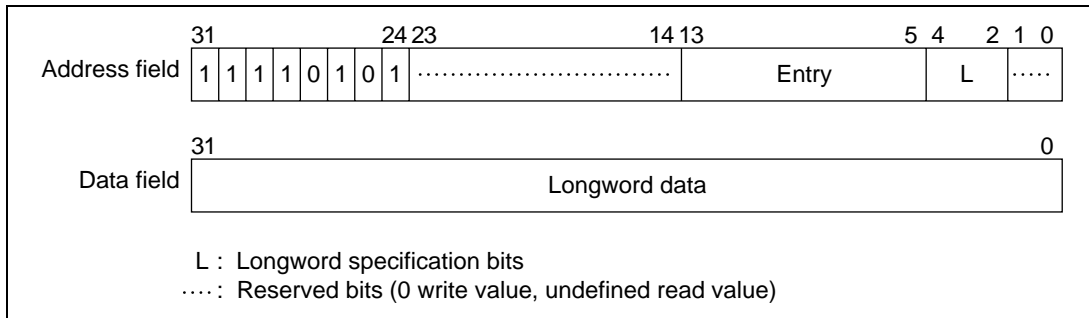

**Figure 4.9 Memory-Mapped OC Data Array**



## 4.6 Store Queues

Two 32-byte store queues (SQs) are supported to perform high-speed writes to external memory.

### 4.6.1 SQ Configuration

There are two 32-byte store queues, SQ0 and SQ1, as shown in figure 4.10. These two store queues can be set independently.

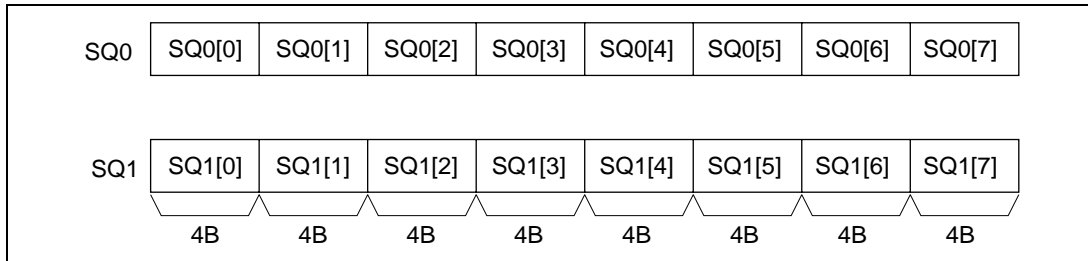

**Figure 4.10 Store Queue Configuration**

### 4.6.2 SQ Writes

A write to the SQs can be performed using a store instruction (MOV) on P4 area H'E000 0000 to H'E3FF FFFC. A longword or quadword access size can be used. The meaning of the address bits is as follows:

[31:26]:	111000	Store queue specification
[25:6]:	Don't care	Used for external memory transfer/access right
[5]:	0/1	0: SQ0 specification    1: SQ1 specification
[4:2]:	LW specification	Specifies longword position in SQ0/SQ1
[1:0]	00	Fixed at 0

### 4.6.3 Transfer to External Memory

Transfer from the SQs to external memory can be performed with a prefetch instruction (PREF). Issuing a PREF instruction for P4 area H'E000 0000 to H'E3FF FFFC starts a burst transfer from the SQs to external memory. The burst transfer length is fixed at 32 bytes, and the start address is always at a 32-byte boundary. While the contents of one SQ are being transferred to external memory, the other SQ can be written to without a penalty cycle, but writing to the SQ involved in the transfer to external memory is deferred until the transfer is completed.

The SQ transfer destination external memory address bit [28:0] specification is as shown below, according to whether the MMU is on or off.

- When MMU is on

The SQ area (H'E000 0000 to H'E3FF FFFF) is set in VPN of the UTLB, and the transfer destination external memory address in PPN. The ASID, V, SZ, SH, PR, and D bits have the same meaning as for normal address translation, but the C and WT bits have no meaning with regard to this page. Since burst transfer is prohibited for PCMCIA areas, the SA and TC bits also have no meaning.

When a prefetch instruction is issued for the SQ area, address translation is performed and external memory address bits [28:10] are generated in accordance with the SZ bit specification. For external memory address bits [9:5], the address prior to address translation is generated in the same way as when the MMU is off. External memory address bits [4:0] are fixed at 0. Transfer from the SQs to external memory is performed to this address.

- When MMU is off

The SQ area (H'E000 0000 to H'E3FF FFFF) is specified as the address at which a prefetch is performed. The meaning of address bits [31:0] is as follows:

[31:26]:	111000	Store queue specification
[25:6]:	Address	External memory address bits [25:6]
[5]:	0/1	0: SQ0 specification 1: SQ1 specification and external memory address bit [5]
[4:2]:	Don't care	No meaning in a prefetch
[1:0]	00	Fixed at 0

External memory address bits [28:26], which cannot be generated from the above address, are generated from the QACR0/1 registers.

QACR0 [4:2]: External memory address bits [28:26] corresponding to SQ0

QACR1 [4:2]: External memory address bits [28:26] corresponding to SQ1

External memory address bits [4:0] are always fixed at 0 since burst transfer starts at a 32-byte boundary.

#### 4.6.4 SQ Protection

It is possible to set protection against SQ writes and transfers to external memory. If an SQ write violates the protection setting, an exception will be generated but the SQ contents will be corrupted. If a transfer from the SQs to external memory (prefetch instruction) violates the protection setting, the transfer to external memory will be inhibited and an exception will be generated.

- When MMU is on  
Operation is in accordance with the address translation information recorded in the UTLB, and MMUCR.SQMD. Write type exception judgment is performed for writes to the SQs, and read type for transfer from the SQs to external memory (PREF instruction), and a TLB miss exception, protection violation exception, or initial page write exception is generated. However, if SQ access is enabled, in privileged mode only, by MMUCR.SQMD, an address error will be flagged in user mode even if address translation is successful.
- When MMU is off  
Operation is in accordance with MMUCR.SQMD.  
0: Privileged/user access possible  
1: Privileged access possible  
If the SQ area is accessed in user mode when MMUCR.SQMD is set to 1, an address error will be flagged.

# Section 5 Exceptions

## 5.1 Overview

### 5.1.1 Features

Exception handling is processing handled by a special routine, separate from normal program processing, that is executed by the CPU in case of abnormal events. For example, if the executing instruction ends abnormally, appropriate action must be taken in order to return to the original program sequence, or report the abnormality before terminating the processing. The process of generating an exception handling request in response to abnormal termination, and passing control to a user-written exception handling routine, in order to support such functions, is given the generic name of exception handling.

SH7750 exception handling is of three kinds: for resets, general exceptions, and interrupts.

### 5.1.2 Register Configuration

The registers used in exception handling are shown in table 5.1.

**Table 5.1 Exception-Related Registers**

Name	Abbrevia- tion	R/W	Initial Value* <sup>1</sup>	P4 Address* <sup>2</sup>	Area 7 Address* <sup>2</sup>	Access Size
TRAPA exception register	TRA	R/W	Undefined	H'FF00 0020	H'1F00 0020	32
Exception event register	EXPEVT	R/W	H'0000 0000/ H'0000 0020* <sup>1</sup>	H'FF00 0024	H'1F00 0024	32
Interrupt event register	INTEVT	R/W	Undefined	H'FF00 0028	H'1F00 0028	32

- Notes: 1. H'0000 0000 is set in a power-on reset, and H'0000 0020 in a manual reset.  
2. This is the address when using the virtual/physical address space P4 area. When making an access from physical address space area 7 using the TLB, the upper 3 bits of the address are ignored.

## 5.2 Register Descriptions

There are three registers related to exception handling. These are allocated to memory, and can be accessed by specifying the P4 address or area 7 address.

1. The exception event register (EXPEVT) resides at P4 address H'FF00 0024, and contains a 12-bit exception code. The exception code set in EXPEVT is that for a reset or general exception event. The exception code is set automatically by hardware when an exception occurs. EXPEVT can also be modified by software.
2. The interrupt event register (INTEVT) resides at P4 address H'FF00 0028, and contains a 12-bit exception code. The exception code set in INTEVT is that for an interrupt request. The exception code is set automatically by hardware when an exception occurs. INTEVT can also be modified by software.
3. The TRAPA exception register (TRA) resides at P4 address H'FF00 0020, and contains 8-bit immediate data (imm) for the TRAPA instruction. TRA is set automatically by hardware when a TRAPA instruction is executed. TRA can also be modified by software.

The bit configurations of EXPEVT, INTEVT, and TRA are shown in figure 5.1.

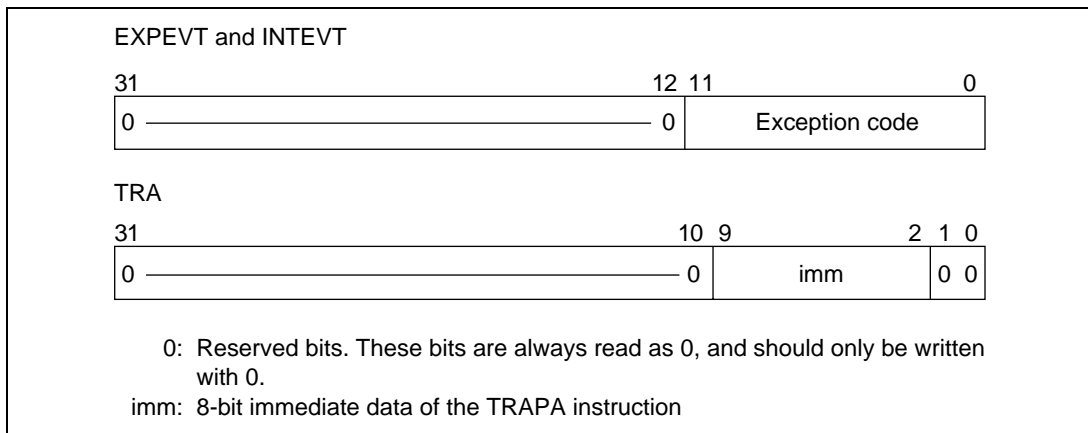

**Figure 5.1 Register Bit Configurations**

## 5.3 Exception Handling Functions

### 5.3.1 Exception Handling Flow

In exception handling, the contents of the program counter (PC), status register (SR), and R15 are saved in the saved program counter (SPC), saved status register (SSR), and saved general register15 (SGR), and the CPU starts execution of the appropriate exception handling routine according to the vector address. An exception handling routine is a program written by the user to handle a specific exception. The exception handling routine is terminated and control returned to the original program by executing a return-from-exception instruction (RTE). This instruction restores the PC and SR contents and returns control to the normal processing routine at the point at which the exception occurred.

The SGR contents are not written back to R15 by an RTE instruction.

The basic processing flow is as follows. See section 2, Data Formats and Registers, for the meaning of the individual SR bits.

1. The PC, SR, and R15 contents are saved in SPC, SSR, and SGR.
2. The block bit (BL) in SR is set to 1.
3. The mode bit (MD) in SR is set to 1.
4. The register bank bit (RB) in SR is set to 1.
5. In a reset, the FPU disable bit (FD) in SR is cleared to 0.
6. The exception code is written to bits 11–0 of the exception event register (EXPEVT) or interrupt event register (INTEVT).
7. The CPU branches to the determined exception handling vector address, and the exception handling routine begins.

### 5.3.2 Exception Handling Vector Addresses

The reset vector address is fixed at H'A000 0000. Exception and interrupt vector addresses are determined by adding the offset for the specific event to the vector base address, which is set by software in the vector base register (VBR). In the case of the TLB miss exception, for example, the offset is H'0000 0400, so if H'9C08 0000 is set in VBR, the exception handling vector address will be H'9C08 0400. If a further exception occurs at the exception handling vector address, a duplicate exception will result, and recovery will be difficult; therefore, fixed physical addresses (P1, P2) should be specified for vector addresses.

## 5.4 Exception Types and Priorities

Table 5.2 shows the types of exceptions, with their relative priorities, vector addresses, and exception/interrupt codes.

**Table 5.2 Exceptions**

Exception Category	Execution Mode	Exception	Priority Level	Priority Order	Vector Address	Offset	Exception Code		
Reset	Abort type	Power-on reset	1	1	H'A000 0000	—	H'000		
		Manual reset	1	2	H'A000 0000	—	H'020		
		Hitachi-UDI reset	1	1	H'A000 0000	—	H'000		
		Instruction TLB multiple-hit exception	1	3	H'A000 0000	—	H'140		
		Data TLB multiple-hit exception	1	4	H'A000 0000	—	H'140		
General exception	Re-execution type	User break before instruction execution* <sup>1</sup>	2	0	(VBR/DBR)	H'100/—	H'1E0		
		Instruction address error	2	1	(VBR)	H'100	H'0E0		
		Instruction TLB miss exception	2	2	(VBR)	H'400	H'040		
		Instruction TLB protection violation exception	2	3	(VBR)	H'100	H'0A0		
		General illegal instruction exception	2	4	(VBR)	H'100	H'180		
		Slot illegal instruction exception	2	4	(VBR)	H'100	H'1A0		
		General FPU disable exception	2	4	(VBR)	H'100	H'800		
		Slot FPU disable exception	2	4	(VBR)	H'100	H'820		
		Data address error (read)	2	5	(VBR)	H'100	H'0E0		
		Data address error (write)	2	5	(VBR)	H'100	H'100		
		Data TLB miss exception (read)	2	6	(VBR)	H'400	H'040		
		Data TLB miss exception (write)	2	6	(VBR)	H'400	H'060		
		Data TLB protection violation exception (read)	2	7	(VBR)	H'100	H'0A0		
		Data TLB protection violation exception (write)	2	7	(VBR)	H'100	H'0C0		
		FPU exception	2	8	(VBR)	H'100	H'120		
		Initial page write exception	2	9	(VBR)	H'100	H'080		
		Completion type	Unconditional trap (TRAPA)		2	4	(VBR)	H'100	H'160
				User break after instruction execution* <sup>1</sup>	2	10	(VBR/DBR)	H'100/—	H'1E0

**Table 5.2 Exceptions (cont)**

Exception Category	Execution Mode	Exception	Priority Level	Priority Order	Vector Address	Offset	Exception Code		
Interrupt	Completion type	Nonmaskable interrupt	3	—	(VBR)	H'600	H'1C0		
		External interrupts	0	4	*2	(VBR)	H'600	H'200	
							H'220		
							H'240		
							H'260		
							H'280		
							H'2A0		
							H'2C0		
							H'2E0		
							H'300		
							H'320		
							H'340		
							H'360		
							H'380		
							H'3A0		
							H'3C0		
Peripheral module interrupt (module/source)		TMU0	TUNIO	4	*2	(VBR)	H'600	H'400	
		TMU1	TUNI1					H'420	
		TMU2	TUNI2					H'440	
			TICPI2					H'460	
		RTC	ATI						H'480
			PRI						H'4A0
			CUI						H'4C0
		SCI	ERI						H'4E0
			RXI						H'500
			TXI						H'520
			TEI						H'540
		WDT	ITI					H'560	
		REF	RCMI						H'580
			ROVI						H'5A0
		Hitachi-UDI	Hitachi-UDI					H'600	
GPIO	GPIOI					H'620			



**Table 5.2 Exceptions (cont)**

Exception Category	Execution Mode	Exception	Priority Level	Priority Order	Vector Address	Offset	Exception Code
Interrupt	Completion type	Peripheral module interrupt (module/source)	DMTE0	4	(VBR)	H'600	H'640
			DMTE1				H'660
			DMTE2				H'680
			DMTE3				H'6A0
			DMAE				H'6C0
			SCIF	ERI			H'700
				RXI			H'720
				BRI			H'740
				TXI			H'760

Priority: Priority is first assigned by priority level, then by priority order within each level (the lowest number represents the highest priority).

Exception transition destination: Control passes to H'A000 0000 in a reset, and to [VBR + offset] in other cases.

Exception code: Stored in EXPEVT for a reset or general exception, and in INTEVT for an interrupt.

IRL: Interrupt request level (pins IRL3–IRL0).

Module/source: See the sections on the relevant peripheral modules.

- Notes: 1. When BRCR.UBDE = 1, PC = DBR. In other cases, PC = VBR + H'100.  
 2. The priority order of external interrupts and peripheral module interrupts can be set by software.

## 5.5 Exception Flow

### 5.5.1 Exception Flow

Figure 5.2 shows an outline flowchart of the basic operations in instruction execution and exception handling. For the sake of clarity, the following description assumes that instructions are executed sequentially, one by one. Figure 5.2 shows the relative priority order of the different kinds of exceptions (reset/general exception/interrupt). Register settings in the event of an exception are shown only for SSR, SPC, SGR, EXPEVT/INTEVT, SR, and PC, but other registers may be set automatically by hardware, depending on the exception. For details, see section 5.6, Description of Exceptions. Also, see section 5.6.4, Priority Order with Multiple Exceptions, for exception handling during execution of a delayed branch instruction and a delay slot instruction, and in the case of instructions in which two data accesses are performed.

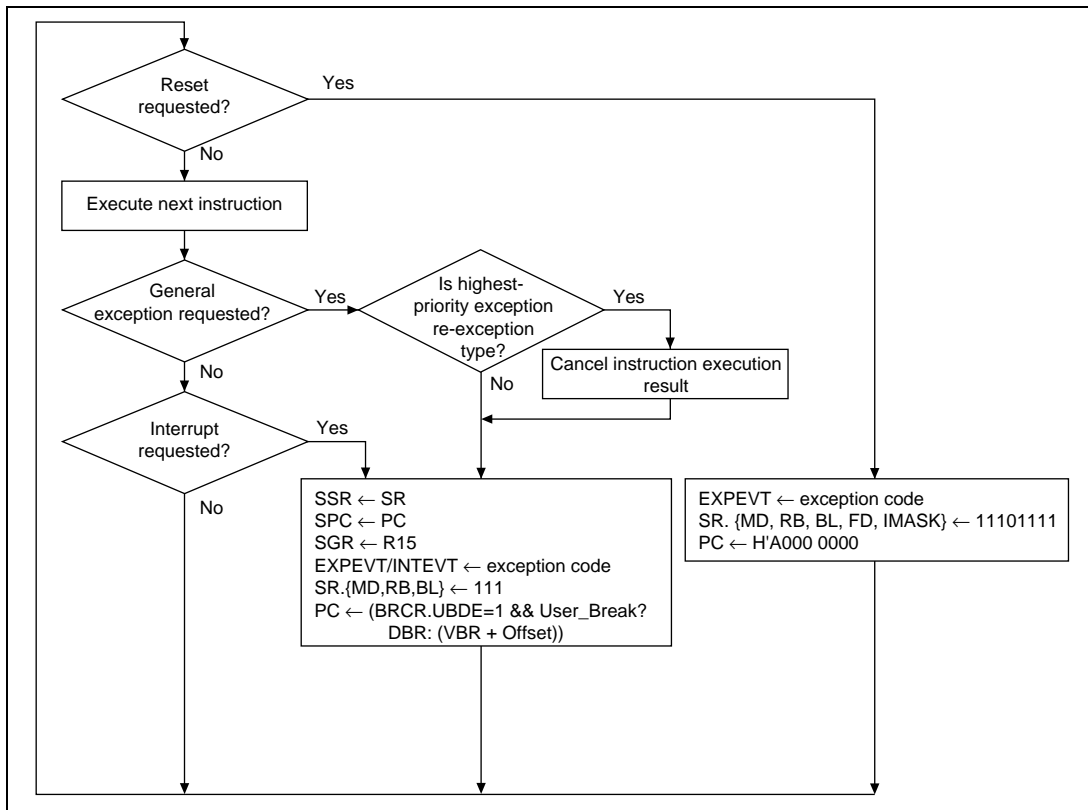

**Figure 5.2 Instruction Execution and Exception Handling**

### 5.5.2 Exception Source Acceptance

A priority ranking is provided for all exceptions for use in determining which of two or more simultaneously generated exceptions should be accepted. Five of the general exceptions—the general illegal instruction exception, slot illegal instruction exception, general FPU disable exception, slot FPU disable exception, and unconditional trap exception—are detected in the process of instruction decoding, and do not occur simultaneously in the instruction pipeline. These exceptions therefore all have the same priority. General exceptions are detected in the order of instruction execution. However, exception handling is performed in the order of instruction flow (program order). Thus, an exception for an earlier instruction is accepted before that for a later instruction. An example of the order of acceptance for general exceptions is shown in figure 5.3.

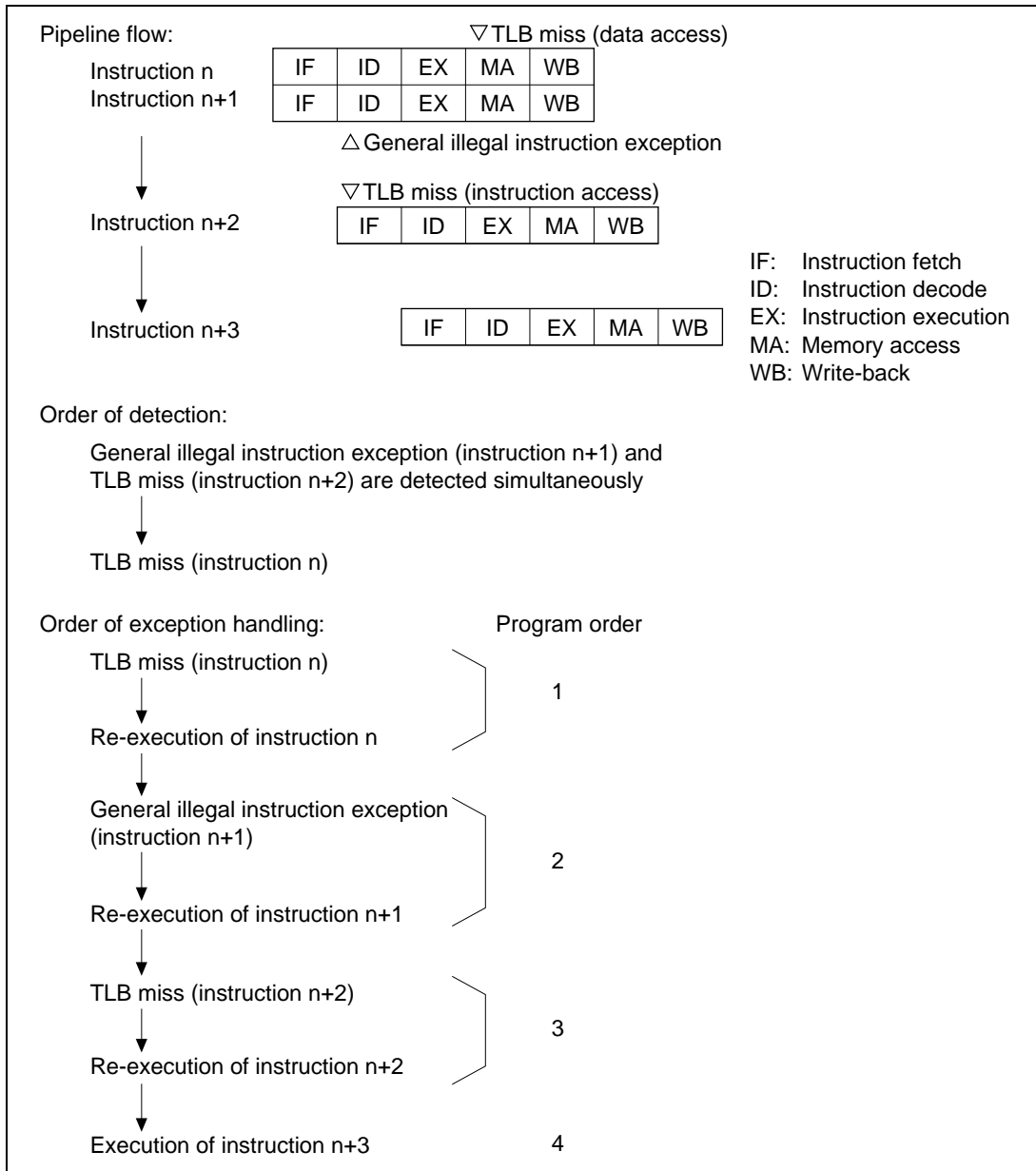

**Figure 5.3 Example of General Exception Acceptance Order**

### **5.5.3 Exception Requests and BL Bit**

When the BL bit in SR is 0, exceptions and interrupts are accepted.

When the BL bit in SR is 1 and an exception other than a user break is generated, the CPU's internal registers and the registers of the other modules are set to their states following a manual reset, and the CPU branches to the same address as in a reset (H'A000 0000). For the operation in the event of a user break, see section 20, User Break Controller in the hardware manual. If an ordinary interrupt occurs, the interrupt request is held pending and is accepted after the BL bit has been cleared to 0 by software. If a nonmaskable interrupt (NMI) occurs, it can be held pending or accepted according to the setting made by software.

Thus, normally, SPC and SSR are saved and then the BL bit in SR is cleared to 0, to enable multiple exception state acceptance.

### **5.5.4 Return from Exception Handling**

The RTE instruction is used to return from exception handling. When the RTE instruction is executed, the SPC contents are restored to PC and the SSR contents to SR, and the CPU returns from the exception handling routine by branching to the SPC address. If SPC and SSR were saved to external memory, set the BL bit in SR to 1 before restoring the SPC and SSR contents and issuing the RTE instruction.

## **5.6 Description of Exceptions**

The various exception handling operations are described here, covering exception sources, transition addresses, and processor operation when a transition is made.

## 5.6.1 Resets

### (1) Power-On Reset

- Sources:
  - SCK2 pin high level and  $\overline{\text{RESET}}$  pin low level
  - When the watchdog timer overflows while the  $\overline{\text{WT/IT}}$  bit is set to 1 and the RSTS bit is cleared to 0 in WTCSR. For details, see section 10, Clock Oscillation Circuits.

- Transition address: H'A000 0000

- Transition operations:

Exception code H'000 is set in EXPEVT, initialization of VBR and SR is performed, and a branch is made to PC = H'A000 0000.

In the initialization processing, the VBR register is set to H'0000 0000, and in SR, the MD, RB, and BL bits are set to 1, the FD bit is cleared to 0, and the interrupt mask bits (I3–I0) are set to B'1111.

CPU and on-chip peripheral module initialization is performed. For details, see the register descriptions in the relevant sections. For some CPU functions, the  $\overline{\text{TRST}}$  pin and  $\overline{\text{RESET}}$  pin must be driven low. It is therefore essential to execute a power-on reset and drive the  $\overline{\text{TRST}}$  pin low when powering on.

If the SCK2 pin is changed to the low level while the  $\overline{\text{RESET}}$  pin is low, a manual reset may occur after the power-on reset operation. Do not drive the SCK2 pin low during this interval (see figure 23.3 in the hardware manual section 23 Electrical Characteristics).

```
Power_on_reset()  
{  
    EXPEVT = H'00000000;  
    VBR = H'00000000;  
    SR.MD = 1;  
    SR.RB = 1;  
    SR.BL = 1;  
    SR.(I0-I3) = B'1111;  
    SR.FD=0;  
    Initialize_CPU();  
    Initialize_Module(PowerOn);  
    PC = H'A0000000;  
}
```

## (2) Manual Reset

- Sources:
  - SCK2 pin low level and  $\overline{\text{RESET}}$  pin low level
  - When a general exception other than a user break occurs while the BL bit is set to 1 in SR
  - When the watchdog timer overflows while the RSTS bit is set to 1 in WTCSR. For details, see section 10, Clock Oscillation Circuits.
- Transition address: H'A000 0000
- Transition operations:

Exception code H'020 is set in EXPEVT, initialization of VBR and SR is performed, and a branch is made to PC = H'A000 0000.

In the initialization processing, the VBR register is set to H'0000 0000, and in SR, the MD, RB, and BL bits are set to 1, the FD bit is cleared to 0, and the interrupt mask bits (I3–I0) are set to B'1111.

CPU and on-chip peripheral module initialization is performed. For details, see the register descriptions in the relevant sections.

```
Manual_reset()  
{  
    EXPEVT = H'00000020;  
    VBR = H'00000000;  
    SR.MD = 1;  
    SR.RB = 1;  
    SR.BL = 1;  
  
    SR.(I0-I3) = B'1111;  
    SR.FD = 0;  
    Initialize_CPU();  
    Initialize_Module(Manual);  
    PC = H'A0000000;  
}
```

**Table 5-3 Types of Reset**

Type	Reset State Transition Conditions		Internal States	
	$\overline{SCK2}$	$\overline{RESET}$	CPU	On-Chip Peripheral Modules
Power-on reset	High	Low	Initialized	See Register Configuration in each section
Manual reset	Low	Low	Initialized	

**(3) Hitachi-UDI Reset**

- Source: SDIR.TI3–TI0 = B'0110 (negation) or B'0111 (assertion)
- Transition address: H'A000 0000
- Transition operations:

Exception code H'000 is set in EXPEVT, initialization of VBR and SR is performed, and a branch is made to PC = H'A000 0000.

In the initialization processing, the VBR register is set to H'0000 0000, and in SR, the MD, RB, and BL bits are set to 1, the FD bit is cleared to 0, and the interrupt mask bits (I3–I0) are set to B'1111.

CPU and on-chip peripheral module initialization is performed. For details, see the register descriptions in the relevant sections.

```
Hitachi-UDI_reset()
{
    EXPEVT = H'00000000;
    VBR = H'00000000;
    SR.MD = 1;
    SR.RB = 1;
    SR.BL = 1;
    SR.(I0-I3) = B'1111;
    SR.FD = 0;
    Initialize_CPU();
    Initialize_Module(PowerOn);
    PC = H'A0000000;
}
```

#### (4) Instruction TLB Multiple-Hit Exception

- Source: Multiple ITLB address matches
- Transition address: H'A000 0000
- Transition operations:

The virtual address (32 bits) at which this exception occurred is set in TEA, and the corresponding virtual page number (22 bits) is set in PTEH [31:10]. ASID in PTEH indicates the ASID when this exception occurred.

Exception code H'140 is set in EXPEVT, initialization of VBR and SR is performed, and a branch is made to PC = H'A000 0000.

In the initialization processing, the VBR register is set to H'0000 0000, and in SR, the MD, RB, and BL bits are set to 1, the FD bit is cleared to 0, and the interrupt mask bits (I3–I0) are set to B'1111.

CPU and on-chip peripheral module initialization is performed in the same way as in a manual reset. For details, see the register descriptions in the relevant sections.

```
TLB_multi_hit()  
{  
    TEA = EXCEPTION_ADDRESS;  
    PTEH.VPN = PAGE_NUMBER;  
    EXPEVT = H'00000140;  
    VBR = H'00000000;  
    SR.MD = 1;  
    SR.RB = 1;  
    SR.BL = 1;  
    SR.(I0-I3) = B'1111;  
    SR.FD = 0;  
    Initialize_CPU();  
    Initialize_Module(Manual);  
    PC = H'A0000000;  
}
```



### (5) Operand TLB Multiple-Hit Exception

- Source: Multiple UTLB address matches
- Transition address: H'A000 0000
- Transition operations:

The virtual address (32 bits) at which this exception occurred is set in TEA, and the corresponding virtual page number (22 bits) is set in PTEH [31:10]. ASID in PTEH indicates the ASID when this exception occurred.

Exception code H'140 is set in EXPEVT, initialization of VBR and SR is performed, and a branch is made to PC = H'A000 0000.

In the initialization processing, the VBR register is set to H'0000 0000, and in SR, the MD, RB, and BL bits are set to 1, the FD bit is cleared to 0, and the interrupt mask bits (I3–I0) are set to B'1111.

CPU and on-chip peripheral module initialization is performed in the same way as in a manual reset. For details, see the register descriptions in the relevant sections.

```
TLB_multi_hit()  
{  
    TEA = EXCEPTION_ADDRESS;  
    PTEH.VPN = PAGE_NUMBER;  
    EXPEVT = H'00000140;  
    VBR = H'00000000;  
    SR.MD = 1;  
    SR.RB = 1;  
    SR.BL = 1;  
    SR.(I0-I3) = B'1111;  
    SR.FD = 0;  
    Initialize_CPU();  
    Initialize_Module(Manual);  
    PC = H'A0000000;  
}
```

## 5.6.2 General Exceptions

### (1) Data TLB Miss Exception

- Source: Address mismatch in UTLB address comparison
- Transition address: VBR + H'0000 0400
- Transition operations:

The virtual address (32 bits) at which this exception occurred is set in TEA, and the corresponding virtual page number (22 bits) is set in PTEH [31:10]. ASID in PTEH indicates the ASID when this exception occurred.

The PC and SR contents for the instruction at which this exception occurred are saved in SPC and SSR, and the contents of R15 are saved in SGR.

Exception code H'040 (for a read access) or H'060 (for a write access) is set in EXPEVT. The BL, MD, and RB bits are set to 1 in SR, and a branch is made to PC = VBR + H'0400.

To speed up TLB miss processing, the offset is separate from that of other exceptions.

```
Data_TLB_miss_exception()  
{  
    TEA = EXCEPTION_ADDRESS;  
    PTEH.VPN = PAGE_NUMBER;  
    SPC = PC;  
    SSR = SR;  
    SGR = R15;  
    EXPEVT = read_access ? H'00000040 : H'00000060;  
    SR.MD = 1;  
    SR.RB = 1;  
    SR.BL = 1;  
    PC = VBR + H'00000400;  
}
```

## (2) Instruction TLB Miss Exception

- Source: Address mismatch in ITLB address comparison
- Transition address: VBR + H'0000 0400
- Transition operations:

The virtual address (32 bits) at which this exception occurred is set in TEA, and the corresponding virtual page number (22 bits) is set in PTEH [31:10]. ASID in PTEH indicates the ASID when this exception occurred.

The PC and SR contents for the instruction at which this exception occurred are saved in SPC and SSR, and the contents of R15 are saved in SGR.

Exception code H'040 is set in EXPEVT. The BL, MD, and RB bits are set to 1 in SR, and a branch is made to PC = VBR + H'0400.

To speed up TLB miss processing, the offset is separate from that of other exceptions.

```
ITLB_miss_exception()  
{  
    TEA = EXCEPTION_ADDRESS;  
    PTEH.VPN = PAGE_NUMBER;  
    SPC = PC;  
    SSR = SR;  
    SGR = R15;  
    EXPEVT = H'00000040;  
    SR.MD = 1;  
    SR.RB = 1;  
    SR.BL = 1;  
    PC = VBR + H'00000400;  
}
```

### (3) Initial Page Write Exception

- Source: TLB is hit in a store access, but dirty bit D = 0
- Transition address: VBR + H'0000 0100
- Transition operations:

The virtual address (32 bits) at which this exception occurred is set in TEA, and the corresponding virtual page number (22 bits) is set in PTEH [31:10]. ASID in PTEH indicates the ASID when this exception occurred.

The PC and SR contents for the instruction at which this exception occurred are saved in SPC and SSR, and the contents of R15 are saved in SGR.

Exception code H'080 is set in EXPEVT. The BL, MD, and RB bits are set to 1 in SR, and a branch is made to PC = VBR + H'0100.

```
Initial_write_exception()
{
    TEA = EXCEPTION_ADDRESS;
    PTEH.VPN = PAGE_NUMBER;
    SPC = PC;
    SSR = SR;
    SGR = R15;
    EXPEVT = H'00000080;
    SR.MD = 1;
    SR.RB = 1;
    SR.BL = 1;
    PC = VBR + H'00000100;
}
```

#### (4) Data TLB Protection Violation Exception

- Source: The access does not accord with the UTLB protection information (PR bits) shown below.

PR	Privileged Mode	User Mode
00	Only read access possible	Access not possible
01	Read/write access possible	Access not possible
10	Only read access possible	Only read access possible
11	Read/write access possible	Read/write access possible

- Transition address: VBR + H'0000 0100
- Transition operations:

The virtual address (32 bits) at which this exception occurred is set in TEA, and the corresponding virtual page number (22 bits) is set in PTEH [31:10]. ASID in PTEH indicates the ASID when this exception occurred.

The PC and SR contents for the instruction at which this exception occurred are saved in SPC and SSR, and the contents of R15 are saved in SGR.

Exception code H'0A0 (for a read access) or H'0C0 (for a write access) is set in EXPEVT. The BL, MD, and RB bits are set to 1 in SR, and a branch is made to PC = VBR + H'0100.

```
Data_TLB_protection_violation_exception()  
{  
    TEA = EXCEPTION_ADDRESS;  
    PTEH.VPN = PAGE_NUMBER;  
    SPC = PC;  
    SSR = SR;  
    SGR = R15;  
    EXPEVT = read_access ? H'000000A0 : H'000000C0;  
    SR.MD = 1;  
    SR.RB = 1;  
    SR.BL = 1;  
    PC = VBR + H'00000100;  
}
```

### (5) Instruction TLB Protection Violation Exception

- Source: The access does not accord with the ITLB protection information (PR bits) shown below.

PR	Privileged Mode	User Mode
0	Access possible	Access not possible
1	Access possible	Access possible

- Transition address: VBR + H'0000 0100

- Transition operations:

The virtual address (32 bits) at which this exception occurred is set in TEA, and the corresponding virtual page number (22 bits) is set in PTEH [31:10]. ASID in PTEH indicates the ASID when this exception occurred.

The PC and SR contents for the instruction at which this exception occurred are saved in SPC and SSR, and the contents of R15 are saved in SGR.

Exception code H'0A0 is set in EXPEVT. The BL, MD, and RB bits are set to 1 in SR, and a branch is made to PC = VBR + H'0100.

```
ITLB_protection_violation_exception()  
{  
    TEA = EXCEPTION_ADDRESS;  
    PTEH.VPN = PAGE_NUMBER;  
    SPC = PC;  
    SSR = SR;  
    SGR = R15;  
    EXPEVT = H'000000A0;  
    SR.MD = 1;  
    SR.RB = 1;  
    SR.BL = 1;  
    PC = VBR + H'00000100;  
}
```

## (6) Data Address Error

- Sources:
  - Word data access from other than a word boundary ( $2n + 1$ )
  - Longword data access from other than a longword data boundary ( $4n + 1$ ,  $4n + 2$ , or  $4n + 3$ )
  - Quadword data access from other than a quadword data boundary ( $8n + 1$ ,  $8n + 2$ ,  $8n + 3$ ,  $8n + 4$ ,  $8n + 5$ ,  $8n + 6$ , or  $8n + 7$ )
  - Access to area H'8000 0000–H'FFFF FFFF in user mode
- Transition address: VBR + H'0000 0100
- Transition operations:

The virtual address (32 bits) at which this exception occurred is set in TEA, and the corresponding virtual page number (22 bits) is set in PTEH [31:10]. ASID in PTEH indicates the ASID when this exception occurred.

The PC and SR contents for the instruction at which this exception occurred are saved in SPC and SSR, and the contents of R15 are saved in SGR.

Exception code H'0E0 (for a read access) or H'100 (for a write access) is set in EXPEVT. The BL, MD, and RB bits are set to 1 in SR, and a branch is made to PC = VBR + H'0100. For details, see section 3, Memory Management Unit (MMU).

```
Data_address_error()  
{  
    TEA = EXCEPTION_ADDRESS;  
    PTEN.VPN = PAGE_NUMBER;  
    SPC = PC;  
    SSR = SR;  
    SGR = R15;  
    EXPEVT = read_access? H'000000E0: H'00000100;  
    SR.MD = 1;  
    SR.RB = 1;  
    SR.BL = 1;  
    PC = VBR + H'00000100;  
}
```

## (7) Instruction Address Error

- Sources:
  - Instruction fetch from other than a word boundary ( $2n + 1$ )
  - Instruction fetch from area H'8000 0000–H'FFFF FFFF in user mode
- Transition address: VBR + H'0000 0100

- Transition operations:

The virtual address (32 bits) at which this exception occurred is set in TEA, and the corresponding virtual page number (22 bits) is set in PTEH [31:10]. ASID in PTEH indicates the ASID when this exception occurred.

The PC and SR contents for the instruction at which this exception occurred are saved in SPC and SSR, and the contents of R15 are saved in SGR.

Exception code H'0E0 is set in EXPEVT. The BL, MD, and RB bits are set to 1 in SR, and a branch is made to PC = VBR + H'0100. For details, see section 3, Memory Management Unit (MMU).

```
Instruction_address_error()  
{  
    TEA = EXCEPTION_ADDRESS;  
    PTEN.VPN = PAGE_NUMBER;  
    SPC = PC;  
    SSR = SR;  
    SGR = R15;  
    EXPEVT = H'000000E0;  
    SR.MD = 1;  
    SR.RB = 1;  
    SR.BL = 1;  
    PC = VBR + H'00000100;  
}
```



## (8) Unconditional Trap

- Source: Execution of TRAPA instruction
- Transition address: VBR + H'0000 0100
- Transition operations:

As this is a processing-completion-type exception, the PC contents for the instruction following the TRAPA instruction are saved in SPC. The values of SR and R15 when the TRAPA instruction is executed are saved in SSR and SGR. The 8-bit immediate value in the TRAPA instruction is multiplied by 4, and the result is set in TRA [9:0]. Exception code H'160 is set in EXPEVT. The BL, MD, and RB bits are set to 1 in SR, and a branch is made to PC = VBR + H'0100.

```
TRAPA_exception()  
{  
    SPC = PC + 2;  
    SSR = SR;  
    SGR = R15;  
    TRA = imm << 2;  
    EXPEVT = H'00000160;  
    SR.MD = 1;  
    SR.RB = 1;  
    SR.BL = 1;  
    PC = VBR + H'00000100;  
}
```

## (9) General Illegal Instruction Exception

- Sources:
  - Decoding of an undefined instruction not in a delay slot  
Delayed branch instructions: JMP, JSR, BRA, BRAF, BSR, BSRF, RTS, RTE, BT/S, BF/S  
Undefined instruction: H'FFFD
  - Decoding in user mode of a privileged instruction not in a delay slot  
Privileged instructions: LDC, STC, RTE, LDTLB, SLEEP, but excluding LDC/STC instructions that access GBR
- Transition address: VBR + H'0000 0100
- Transition operations:

The PC and SR contents for the instruction at which this exception occurred are saved in SPC and SSR, and the contents of R15 are saved in SGR.

Exception code H'180 is set in EXPEVT. The BL, MD, and RB bits are set to 1 in SR, and a branch is made to PC = VBR + H'0100. Operation is not guaranteed if an undefined code other than H'FFFD is decoded.

```
General_illegal_instruction_exception()  
{  
    SPC = PC;  
    SSR = SR;  
    SGR = R15;  
    EXPEVT = H'00000180;  
    SR.MD = 1;  
    SR.RB = 1;  
    SR.BL = 1;  
    PC = VBR + H'00000100;  
}
```

## (10) Slot Illegal Instruction Exception

- Sources:
  - Decoding of an undefined instruction in a delay slot  
Delayed branch instructions: JMP, JSR, BRA, BRAF, BSR, BSRF, RTS, RTE, BT/S, BF/S  
Undefined instruction: H'FFFD
  - Decoding of an instruction that modifies PC in a delay slot  
Instructions that modify PC: JMP, JSR, BRA, BRAF, BSR, BSRF, RTS, RTE, BT, BF, BT/S, BF/S, TRAPA, LDC Rm, SR, LDC.L @Rm+, SR
  - Decoding in user mode of a privileged instruction in a delay slot  
Privileged instructions: LDC, STC, RTE, LDTLB, SLEEP, but excluding LDC/STC instructions that access GBR
  - Decoding of a PC-relative MOV instruction or MOVA instruction in a delay slot
- Transition address: VBR + H'0000 0100
- Transition operations:

The PC contents for the preceding delayed branch instruction are saved in SPC. The SR and R15 contents when this exception occurred are saved in SSR and SGR.

Exception code H'1A0 is set in EXPEVT. The BL, MD, and RB bits are set to 1 in SR, and a branch is made to PC = VBR + H'0100. Operation is not guaranteed if an undefined code other than H'FFFD is decoded.

```
Slot_illegal_instruction_exception()  
{  
    SPC = PC - 2;  
    SSR = SR;  
    SGR = R15;  
    EXPEVT = H'000001A0;  
    SR.MD = 1;  
    SR.RB = 1;  
    SR.BL = 1;  
    PC = VBR + H'00000100;  
}
```

### (11) General FPU Disable Exception

- Source: Decoding of an FPU instruction\* not in a delay slot with SR.FD =1
- Transition address: VBR + H'0000 0100
- Transition operations:

The PC and SR contents for the instruction at which this exception occurred are saved in SPC and SSR, and the contents of R15 are saved in SGR.

Exception code H'800 is set in EXPEVT. The BL, MD, and RB bits are set to 1 in SR, and a branch is made to PC = VBR + H'0100.

Note: \* FPU instructions are instructions in which the first 4 bits of the instruction code are F (but excluding undefined instruction H'FFFD), and the LDS, STS, LDS.L, and STS.L instructions corresponding to FPUL and FPSCR.

```
General_fpu_disable_exception()  
{  
    SPC = PC;  
    SSR = SR;  
    SGR = R15;  
    EXPEVT = H'00000800;  
    SR.MD = 1;  
    SR.RB = 1;  
    SR.BL = 1;  
    PC = VBR + H'00000100;  
}
```

## (12) Slot FPU Disable Exception

- Source: Decoding of an FPU instruction in a delay slot with SR.FD =1
- Transition address: VBR + H'0000 0100
- Transition operations:

The PC contents for the preceding delayed branch instruction are saved in SPC. The SR and R15 contents when this exception occurred are saved in SSR and SGR.

Exception code H'820 is set in EXPEVT. The BL, MD, and RB bits are set to 1 in SR, and a branch is made to PC = VBR + H'0100.

```
Slot_fpu_disable_exception()  
{  
    SPC = PC - 2;  
    SSR = SR;  
    SGR = R15;  
    EXPEVT = H'00000820;  
    SR.MD = 1;  
    SR.RB = 1;  
    SR.BL = 1;  
    PC = VBR + H'00000100;  
}
```

### (13) User Breakpoint Trap

- Source: Fulfilling of a break condition set in the user break controller
- Transition address: VBR + H'0000 0100, or DBR
- Transition operations:

In the case of a post-execution break, the PC contents for the instruction following the instruction at which the breakpoint is set are set in SPC. In the case of a pre-execution break, the PC contents for the instruction at which the breakpoint is set are set in SPC.

The SR and R15 contents when the break occurred are saved in SSR and SGR. Exception code H'1E0 is set in EXPEVT.

The BL, MD, and RB bits are set to 1 in SR, and a branch is made to PC = VBR + H'0100. It is also possible to branch to PC = DBR.

For details of PC, etc., when a data break is set, see section 20, User Break Controller.

```
User_break_exception()  
{  
    SPC = (pre_execution break? PC : PC + 2);  
    SSR = SR;  
    SGR = R15;  
    EXPEVT = H'000001E0;  
    SR.MD = 1;  
    SR.RB = 1;  
    SR.BL = 1;  
    PC = (BRCR.UBDE==1 ? DBR : VBR + H'00000100);  
}
```

#### (14) FPU Exception

- Source: Exception due to execution of a floating-point operation
- Transition address: VBR + H'0000 0100
- Transition operations:

The PC and SR contents for the instruction at which this exception occurred are saved in SPC and SSR, and the contents of R15 are saved in SGR. Exception code H'120 is set in EXPEVT. The BL, MD, and RB bits are set to 1 in SR, and a branch is made to PC = VBR + H'0100.

```
FPU_exception()  
{  
    SPC = PC;  
    SSR = SR;  
    SGR = R15;  
    EXPEVT = H'00000120;  
    SR.MD = 1;  
    SR.RB = 1;  
    SR.BL = 1;  
    PC = VBR + H'00000100;  
}
```

### 5.6.3 Interrupts

#### (1) NMI

- Source: NMI pin edge detection
- Transition address: VBR + H'0000 0600
- Transition operations:

The contents of PC and SR immediately after the instruction at which this interrupt was accepted are saved in SPC and SSR, and the contents of R15 are saved in SGR.

Exception code H'1C0 is set in INTEVT. The BL, MD, and RB bits are set to 1 in SR, and a branch is made to PC = VBR + H'0600. When the BL bit in SR is 0, this interrupt is not masked by the interrupt mask bits in SR, and is accepted at the highest priority level. When the BL bit in SR is 1, a software setting can specify whether this interrupt is to be masked or accepted. For details, see section 19, Interrupt Controller.

```
NMI ( )  
{  
    SPC = PC;  
    SSR = SR;  
    SGR = R15;  
    INTEVT = H'000001C0;  
    SR.MD = 1;  
    SR.RB = 1;  
    SR.BL = 1;  
    PC = VBR + H'00000600;  
}
```



## (2) IRL Interrupts

- Source: The interrupt mask bit setting in SR is smaller than the IRL (3–0) level, and the BL bit in SR is 0 (accepted at instruction boundary).
- Transition address: VBR + H'0000 0600
- Transition operations:

The PC contents immediately after the instruction at which the interrupt is accepted are set in SPC. The SR and R15 contents at the time of acceptance are set in SSR and SGR.

The code corresponding to the IRL (3–0) level is set in INTEVT. See table 19.5, Interrupt Exception Handling Sources and Priority Order, for the corresponding codes. The BL, MD, and RB bits are set to 1 in SR, and a branch is made to VBR + H'0600. The acceptance level is not set in the interrupt mask bits in SR. When the BL bit in SR is 1, the interrupt is masked. For details, see section 19, Interrupt Controller.

```
IRL( )
{
    SPC = PC;
    SSR = SR;
    SGR = R15;
    INTEVT = H'00000200 ~ H'000003C0;
    SR.MD = 1;
    SR.RB = 1;
    SR.BL = 1;
    PC = VBR + H'00000600;
}
```

### (3) Peripheral Module Interrupts

- Source: The interrupt mask bit setting in SR is smaller than the peripheral module (Hitachi-UDI, GPIO, DMAC, TMU, RTC, SCI, SCIF, WDT, or REF) interrupt level, and the BL bit in SR is 0 (accepted at instruction boundary).

- Transition address: VBR + H'0000 0600

- Transition operations:

The PC contents immediately after the instruction at which the interrupt is accepted are set in SPC. The SR and R15 contents at the time of acceptance are set in SSR and SGR.

The code corresponding to the interrupt source is set in INTEVT. The BL, MD, and RB bits are set to 1 in SR, and a branch is made to VBR + H'0600. The module interrupt levels should be set as values between B'0000 and B'1111 in the interrupt priority registers (IPRA–IPRC) in the interrupt controller. For details, see section 19, Interrupt Controller.

```
Module_interruption()  
{  
    SPC = PC;  
    SSR = SR;  
    SGR = R15;  
    INTEVT = H'00000400 ~ H'00000760;  
    SR.MD = 1;  
    SR.RB = 1;  
    SR.BL = 1;  
    PC = VBR + H'00000600;  
}
```

#### 5.6.4 Priority Order with Multiple Exceptions

With some instructions, such as instructions that make two accesses to memory, and the indivisible pair comprising a delayed branch instruction and delay slot instruction, multiple exceptions occur. Care is required in these cases, as the exception priority order differs from the normal order.

##### 1. Instructions that make two accesses to memory

With MAC instructions, memory-to-memory arithmetic/logic instructions, and TAS instructions, two data transfers are performed by a single instruction, and an exception will be detected for each of these data transfers. In these cases, therefore, the following order is used to determine priority.

- a. Data address error in first data transfer
- b. TLB miss in first data transfer
- c. TLB protection violation in first data transfer
- d. Initial page write exception in first data transfer
- e. Data address error in second data transfer
- f. TLB miss in second data transfer
- g. TLB protection violation in second data transfer
- h. Initial page write exception in second data transfer

##### 2. Indivisible delayed branch instruction and delay slot instruction

As a delayed branch instruction and its associated delay slot instruction are indivisible, they are treated as a single instruction. Consequently, the priority order for exceptions that occur in these instructions differs from the usual priority order. The priority order shown below is for the case where the delay slot instruction has only one data transfer.

- a. The delayed branch instruction is checked for priority levels 1 and 2.
- b. The delay slot instruction is checked for priority levels 1 and 2.
- c. A check is performed for priority level 3 in the delayed branch instruction and priority level 3 in the delay slot instruction. (There is no priority ranking between these two.)
- d. A check is performed for priority level 4 in the delayed branch instruction and priority level 4 in the delay slot instruction. (There is no priority ranking between these two.)

If the delay slot instruction has a second data transfer, two checks are performed in step b, as in 1 above.

If the accepted exception (the highest-priority exception) is a delay slot instruction re-execution type exception, the branch instruction PR register write operation (PC → PR operation performed in BSR, BSRF, JSR) is inhibited.

## 5.7 Usage Notes

1. Return from exception handling
  - a. Check the BL bit in SR with software. If SPC and SSR have been saved to external memory, set the BL bit in SR to 1 before restoring them.
  - b. Issue an RTE instruction. When RTE is executed, the SPC contents are set in PC, the SSR contents are set in SR, and branch is made to the SPC address to return from the exception handling routine.
2. If an exception or interrupt occurs when SR.BL = 1
  - a. Exception

When an exception other than a user break occurs, a manual reset is executed. The value in EXPEVT at this time is H'0000 0020; the value of the SPC and SSR registers is undefined.
  - b. Interrupt

If an ordinary interrupt occurs, the interrupt request is held pending and is accepted after the BL bit in SR has been cleared to 0 by software. If a nonmaskable interrupt (NMI) occurs, it can be held pending or accepted according to the setting made by software. In the sleep or standby state, however, an interrupt is accepted even if the BL bit in SR is set to 1.
3. SPC when an exception occurs
  - a. Re-execution type exception

The PC value for the instruction in which the exception occurred is set in SPC, and the instruction is re-executed after returning from exception handling. If an exception occurs in a delay slot instruction, however, the PC value for the delay slot instruction is saved in SPC regardless of whether or not the preceding delay slot instruction condition is satisfied.
  - b. Completion type exception or interrupt

The PC value for the instruction following that in which the exception occurred is set in SPC. If an exception occurs in a branch instruction with delay slot, however, the PC value for the branch destination is saved in SPC.
4. An exception must not be generated in an RTE instruction delay slot, as the operation will be undefined in this case.

## 5.8 Restrictions

### 1. Restrictions on first instruction of exception handling routine

- Do not locate a BT, BF, BT/S, BF/S, BRA, or BSR instruction at address VBR + H'100, VBR + H'400, or VBR + H'600.
- When the UBDE bit in the BRCCR register is set to 1 and the user break debug support function\* is used, do not locate a BT, BF, BT/S, BF/S, BRA, or BSR instruction at the address indicated by the DBR register.

Note: \* See section 20.4 in the SH-4 Hardware manual.

## Section 6 Floating-Point Unit

### 6.1 Overview

The floating-point unit (FPU) has the following features:

- Conforms to IEEE754 standard
- 32 single-precision floating-point registers (can also be referenced as 16 double-precision registers)
- Two rounding modes: Round to Nearest and Round to Zero
- Two denormalization modes: Flush to Zero and Treat Denormalized Number
- Six exception sources: FPU Error, Invalid Operation, Divide By Zero, Overflow, Underflow, and Inexact
- Comprehensive instructions: Single-precision, double-precision, graphics support, system control

When the FD bit in SR is set to 1, the FPU cannot be used, and an attempt to execute an FPU instruction will cause an FPU disable exception.

### 6.2 Data Formats

#### 6.2.1 Floating-Point Format

A floating-point number consists of the following three fields:

- Sign (s)
- Exponent (e)
- Fraction (f)

The SH7750 can handle single-precision and double-precision floating-point numbers, using the formats shown in figures 6.1 and 6.2.

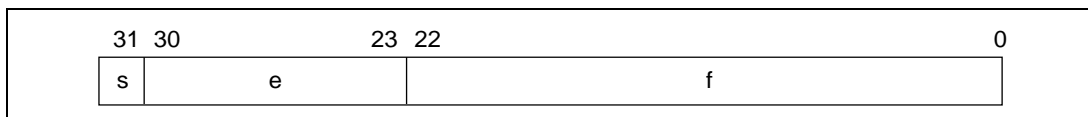

**Figure 6.1 Format of Single-Precision Floating-Point Number**

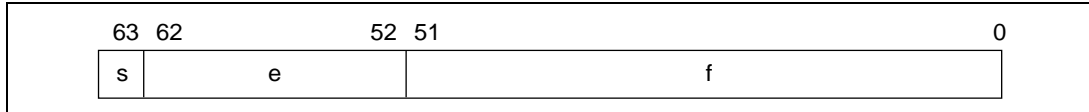

**Figure 6.2 Format of Double-Precision Floating-Point Number**

The exponent is expressed in biased form, as follows:

$$e = E + \text{bias}$$

The range of unbiased exponent  $E$  is  $E_{\min} - 1$  to  $E_{\max} + 1$ . The two values  $E_{\min} - 1$  and  $E_{\max} + 1$  are distinguished as follows.  $E_{\min} - 1$  indicates zero (both positive and negative sign) and a denormalized number, and  $E_{\max} + 1$  indicates positive or negative infinity or a non-number (NaN). Table 6.1 shows bias,  $E_{\min}$ , and  $E_{\max}$  values.

**Table 6.1 Floating-Point Number Formats and Parameters**

Parameter	Single-Precision	Double-Precision
Total bit width	32 bits	64 bits
Sign bit	1 bit	1 bit
Exponent field	8 bits	11 bits
Fraction field	23 bits	52 bits
Precision	24 bits	53 bits
Bias	+127	+1023
$E_{\max}$	+127	+1023
$E_{\min}$	-126	-1022

Floating-point number value  $v$  is determined as follows:

- If  $E = E_{\max} + 1$  and  $f \neq 0$ ,  $v$  is a non-number (NaN) irrespective of sign  $s$
- If  $E = E_{\max} + 1$  and  $f = 0$ ,  $v = (-1)^s$  (infinity) [positive or negative infinity]
- If  $E_{\min} \leq E \leq E_{\max}$ ,  $v = (-1)^s 2^E (1.f)$  [normalized number]
- If  $E = E_{\min} - 1$  and  $f \neq 0$ ,  $v = (-1)^s 2^{E_{\min}} (0.f)$  [denormalized number]
- If  $E = E_{\min} - 1$  and  $f = 0$ ,  $v = (-1)^s 0$  [positive or negative zero]

Table 6.2 shows the ranges of the various numbers in hexadecimal notation.

**Table 6.2 Floating-Point Ranges**

Type	Single-Precision	Double-Precision
Signaling non-number	H'7FFFFFFF to H'7FC00000	H'7FFFFFFF H'FFFFFFFF to H'7FF80000 H'00000000
Quiet non-number	H'7FBFFFFFFF to H'7F800001	H'7FF7FFFF H'FFFFFFFF to H'7FF00000 H'00000001
Positive infinity	H'7F800000	H'7FF00000 H'000000
Positive normalized number	H'7F7FFFFFFF to H'00800000	H'7FEFFFFFFF H'FFFFFFFF to H'00100000 H'00000000
Positive denormalized number	H'007FFFFFFF to H'00000001	H'000FFFFFFF H'FFFFFFFF to H'00000000 H'00000001
Positive zero	H'00000000	H'00000000 H'00000000
Negative zero	H'80000000	H'80000000 H'00000000
Negative denormalized number	H'80000001 to H'807FFFFFFF	H'80000000 H'00000001 to H'800FFFFFFF H'FFFFFFFF
Negative normalized number	H'80800000 to H'FF7FFFFFFF	H'80100000 H'00000000 to H'FFEFFFFFFF H'FFFFFFFF
Negative infinity	H'FF800000	H'FFF00000 H'00000000
Quiet non-number	H'FF800001 to H'FFBFFFFFFF	H'FFF00000 H'00000001 to H'FFF7FFFF H'FFFFFFFF
Signaling non-number	H'FFC00000 to H'FFFFFFFF	H'FFF80000 H'00000000 to H'FFFFFFFF H'FFFFFFFF

**6.2.2 Non-Numbers (NaN)**

Figure 6.3 shows the bit pattern of a non-number (NaN). A value is NaN in the following case:

- Sign bit: Don't care
- Exponent field: All bits are 1
- Fraction field: At least one bit is 1

The NaN is a signaling NaN (sNaN) if the MSB of the fraction field is 1, and a quiet NaN (qNaN) if the MSB is 0.



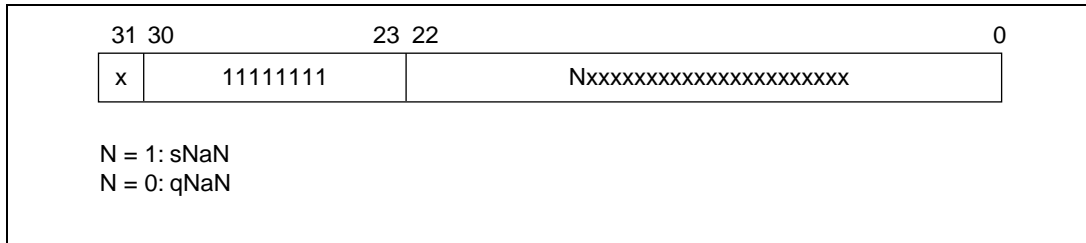

**Figure 6.3 Single-Precision NaN Bit Pattern**

An sNaN is input in an operation, except copy, FABS, and FNEG, that generates a floating-point value.

- When the EN.V bit in the FPSCR register is 0, the operation result (output) is a qNaN.
- When the EN.V bit in the FPSCR register is 1, an invalid operation exception will be generated. In this case, the contents of the operation destination register are unchanged.

If a qNaN is input in an operation that generates a floating-point value, and an sNaN has not been input in that operation, the output will always be a qNaN irrespective of the setting of the EN.V bit in the FPSCR register. An exception will not be generated in this case.

The qNaN values generated by the SH7750 as operation results are as follows:

- Single-precision qNaN: H'7FBFFFFF
- Double-precision qNaN: H'7FF7FFFF FFFFFFFF

See section 10, Instruction Descriptions, for details of floating-point operations when a non-number (NaN) is input.

### 6.2.3 Denormalized Numbers

For a denormalized number floating-point value, the exponent field is expressed as 0, and the fraction field as a non-zero value.

When the DN bit in the FPU's status register FPSCR is 1, a denormalized number (source operand or operation result) is always flushed to 0 in a floating-point operation that generates a value (an operation other than copy, FNEG, or FABS).

When the DN bit in FPSCR is 0, a denormalized number (source operand or operation result) is processed as it is. See section 10, Description of Instructions, for details of floating-point operations when a denormalized number is input.

## 6.3 Registers

### 6.3.1 Floating-Point Registers

Figure 6.4 shows the floating-point register configuration. There are thirty-two 32-bit floating-point registers, referenced by specifying FR0–FR15, DR0/2/4/6/8/10/12/14, FV0/4/8/12, XF0–XF15, XD0/2/4/6/8/10/12/14, or XMTRX.

1. Floating-point registers, FPR<sub>i</sub>\_BANK<sub>j</sub> (32 registers)  
FPR0\_BANK0–FPR15\_BANK0  
FPR0\_BANK1–FPR15\_BANK1
2. Single-precision floating-point registers, FR<sub>i</sub> (16 registers)  
When FPSCR.FR = 0, FR0–FR15 indicate FPR0\_BANK0–FPR15\_BANK0;  
when FPSCR.FR = 1, FR0–FR15 indicate FPR0\_BANK1–FPR15\_BANK1.
3. Double-precision floating-point registers, DR<sub>i</sub> (8 registers): A DR register comprises two FR registers  
DR0 = {FR0, FR1}, DR2 = {FR2, FR3}, DR4 = {FR4, FR5}, DR6 = {FR6, FR7},  
DR8 = {FR8, FR9}, DR10 = {FR10, FR11}, DR12 = {FR12, FR13}, DR14 = {FR14, FR15}
4. Single-precision floating-point vector registers, FV<sub>i</sub> (4 registers): An FV register comprises four FR registers  
FV0 = {FR0, FR1, FR2, FR3}, FV4 = {FR4, FR5, FR6, FR7},  
FV8 = {FR8, FR9, FR10, FR11}, FV12 = {FR12, FR13, FR14, FR15}
5. Single-precision floating-point extended registers, XF<sub>i</sub> (16 registers)  
When FPSCR.FR = 0, XF0–XF15 indicate FPR0\_BANK1–FPR15\_BANK1;  
when FPSCR.FR = 1, XF0–XF15 indicate FPR0\_BANK0–FPR15\_BANK0.
6. Double-precision floating-point extended registers, XD<sub>i</sub> (8 registers): An XD register comprises two XF registers  
XD0 = {XF0, XF1}, XD2 = {XF2, XF3}, XD4 = {XF4, XF5}, XD6 = {XF6, XF7},  
XD8 = {XF8, XF9}, XD10 = {XF10, XF11}, XD12 = {XF12, XF13}, XD14 = {XF14, XF15}
7. Single-precision floating-point extended register matrix, XMTRX: XMTRX comprises all 16 XF registers

$$\text{XMTRX} = \begin{bmatrix} \text{XF0} & \text{XF4} & \text{XF8} & \text{XF12} \\ \text{XF1} & \text{XF5} & \text{XF9} & \text{XF13} \\ \text{XF2} & \text{XF6} & \text{XF10} & \text{XF14} \\ \text{XF3} & \text{XF7} & \text{XF11} & \text{XF15} \end{bmatrix}$$

<u>FPSCR.FR = 0</u>				<u>FPSCR.FR = 1</u>		
FV0	DR0	FR0	FPR0_BANK0	XF0	XD0	XMTRX
		FR1	FPR1_BANK0	XF1		
	DR2	FR2	FPR2_BANK0	XF2	XD2	
FR3		FPR3_BANK0	XF3			
FV4	DR4	FR4	FPR4_BANK0	XF4	XD4	
		FR5	FPR5_BANK0	XF5		
	DR6	FR6	FPR6_BANK0	XF6	XD6	
FR7		FPR7_BANK0	XF7			
FV8	DR8	FR8	FPR8_BANK0	XF8	XD8	
		FR9	FPR9_BANK0	XF9		
	DR10	FR10	FPR10_BANK0	XF10	XD10	
FR11		FPR11_BANK0	XF11			
FV12	DR12	FR12	FPR12_BANK0	XF12	XD12	
		FR13	FPR13_BANK0	XF13		
	DR14	FR14	FPR14_BANK0	XF14	XD14	
FR15		FPR15_BANK0	XF15			
XMTRX	XD0	XF0	FPR0_BANK1	FR0	DR0	FV0
		XF1	FPR1_BANK1	FR1		
	XD2	XF2	FPR2_BANK1	FR2	DR2	
		XF3	FPR3_BANK1	FR3		
	XD4	XF4	FPR4_BANK1	FR4	DR4	FV4
		XF5	FPR5_BANK1	FR5		
	XD6	XF6	FPR6_BANK1	FR6	DR6	
		XF7	FPR7_BANK1	FR7		
	XD8	XF8	FPR8_BANK1	FR8	DR8	FV8
		XF9	FPR9_BANK1	FR9		
	XD10	XF10	FPR10_BANK1	FR10	DR10	
		XF11	FPR11_BANK1	FR11		
	XD12	XF12	FPR12_BANK1	FR12	DR12	FV12
		XF13	FPR13_BANK1	FR13		
	XD14	XF14	FPR14_BANK1	FR14	DR14	
XF15		FPR15_BANK1	FR15			

**Figure 6.4 Floating-Point Registers**

### 6.3.2 Floating-Point Status/Control Register (FPSCR)

**Floating-point status/control register, FPSCR (32 bits, initial value = H'0004 0001)**

- **FR:** Floating-point register bank  
 FR = 0: FPR0\_BANK0–FPR15\_BANK0 are assigned to FR0–FR15; FPR0\_BANK1–FPR15\_BANK1 are assigned to XF0–XF15.  
 FR = 1: FPR0\_BANK0–FPR15\_BANK0 are assigned to XF0–XF15; FPR0\_BANK1–FPR15\_BANK1 are assigned to FR0–FR15.
- **SZ:** Transfer size mode  
 SZ = 0: The data size of the FMOV instruction is 32 bits.  
 SZ = 1: The data size of the FMOV instruction is a 32-bit register pair (64 bits).
- **PR:** Precision mode  
 PR = 0: Floating-point instructions are executed as single-precision operations.  
 PR = 1: Floating-point instructions are executed as double-precision operations (graphics support instructions are undefined).  
 Do not set SZ and PR to 1 simultaneously; this setting is reserved.  
 [SZ, PR = 11]: Reserved (FPU operation instruction is undefined.)
- **DN:** Denormalization mode  
 DN = 0: A denormalized number is treated as such.  
 DN = 1: A denormalized number is treated as zero.

		<b>FPU Error (E)</b>	<b>Invalid Operation (V)</b>	<b>Division by Zero (Z)</b>	<b>Overflow (O)</b>	<b>Underflow (U)</b>	<b>Inexact (I)</b>
Cause	FPU exception cause field	Bit 17	Bit 16	Bit 15	Bit 14	Bit 13	Bit 12
Enable	FPU exception enable field	None	Bit 11	Bit 10	Bit 9	Bit 8	Bit 7
Flag	FPU exception flag field	None	Bit 6	Bit 5	Bit 4	Bit 3	Bit 2

When an FPU exception is requested, the corresponding bits in the cause and flag fields are set to 1. Each time an FPU operation instruction is executed, the cause field is cleared to 0 first. The flag field retains the value of 1 until cleared to 0 by software.

- RM: Rounding mode  
 RM = 00: Round to Nearest  
 RM = 01: Round to Zero  
 RM = 10: Reserved  
 RM = 11: Reserved
- Bits 22 to 31: Reserved  
 These bits are always read as 0, and should only be written with 0.

Notes: The following functions have been added to the FPU of the SH7750 (not provided in the FPU of the SH7718):

1. The FR, SZ, and PR bits have been added.
2. Exception O (overflow), U (underflow), and I (inexact) bits have been added to the cause, enable, and flag fields.
3. An exception E (FPU error) bit has been added to the cause field.

### 6.3.3 Floating-Point Communication Register (FPUL)

Information is transferred between the FPU and CPU via the FPUL register. The 32-bit FPUL register is a system register, and is accessed from the CPU side by means of LDS and STS instructions. For example, to convert the integer stored in general register R1 to a single-precision floating-point number, the processing flow is as follows:

R1 → (LDS instruction) → FPUL → (single-precision FLOAT instruction) → FR1

## 6.4 Rounding

In a floating-point instruction, rounding is performed when generating the final operation result from the intermediate result. Therefore, the result of combination instructions such as FMAC, FTRV, and FIPR will differ from the result when using a basic instruction such as FADD, FSUB, or FMUL. Rounding is performed once in FMAC, but twice in FADD, FSUB, and FMUL.

There are two rounding methods, the method to be used being determined by the RM field in FPSCR.

- RM = 00: Round to Nearest
- RM = 01: Round to Zero

**Round to Nearest:** The value is rounded to the nearest expressible value. If there are two nearest expressible values, the one with an LSB of 0 is selected.

If the unrounded value is  $2^{\text{E}_{\text{max}}} (2 - 2^{\text{P}})$  or more, the result will be infinity with the same sign as the unrounded value. The values of  $\text{E}_{\text{max}}$  and  $\text{P}$ , respectively, are 127 and 24 for single-precision, and 1023 and 53 for double-precision.

**Round to Zero:** The digits below the round bit of the unrounded value are discarded.

If the unrounded value is larger than the maximum expressible absolute value, the value will be the maximum expressible absolute value.

## 6.5 Floating-Point Exceptions

FPU-related exceptions are as follows:

- General illegal instruction/slot illegal instruction exception

The exception occurs if an FPU instruction is executed when  $\text{SR.FD} = 1$ .

- FPU exceptions

The exception sources are as follows:

- FPU error (E): When  $\text{FPSCR.DN} = 0$  and a denormalized number is input
- Invalid operation (V): In case of an invalid operation, such as NaN input
- Division by zero (Z): Division with a zero divisor
- Overflow (O): When the operation result overflows
- Underflow (U): When the operation result underflows
- Inexact exception (I): When overflow, underflow, or rounding occurs

The FPSCR cause field contains bits corresponding to all of above sources E, V, Z, O, U, and I, and the FPSCR flag and enable fields contain bits corresponding to sources V, Z, O, U, and I, but not E. Thus, FPU errors cannot be disabled.

When an exception source occurs, the corresponding bit in the cause field is set to 1, and 1 is added to the corresponding bit in the flag field. When an exception source does not occur, the corresponding bit in the cause field is cleared to 0, but the corresponding bit in the flag field remains unchanged.

- Enable/disable exception handling

The SH7750 supports enable exception handling and disable exception handling.

Enable exception handling is initiated in the following cases:

- FPU error (E):  $\text{FPSCR.DN} = 0$  and a denormalized number is input
- Invalid operation (V):  $\text{FPSCR.EN.V} = 1$  and (instruction = FTRV or invalid operation)
- Division by zero (Z):  $\text{FPSCR.EN.Z} = 1$  and division with a zero divisor
- Overflow (O):  $\text{FPSCR.EN.O} = 1$  and instruction with possibility of operation result overflow

- Underflow (U): FPSCR.EN.U = 1 and instruction with possibility of operation result underflow
- Inexact exception (I): FPSCR.EN.I = 1 and instruction with possibility of inexact operation result

These possibilities are shown in the individual instruction descriptions. All exception events that originate in the FPU are assigned as the same exception event. The meaning of an exception is determined by software by reading system register FPSCR and interpreting the information it contains. If no bits are set in the cause field of FPSCR when one or more of bits O, U, I, and V (in case of FTRV only) are set in the enable field, this indicates that an actual exception source is not generated. Also, the destination register is not changed by any enable exception handling operation.

Except for the above, the FPU disables exception handling. In all processing, the bit corresponding to source V, Z, O, U, or I is set to 1, and disable exception handling is provided for each exception.

- Invalid operation (V): qNaN is generated as the result.
- Division by zero (Z): Infinity with the same sign as the unrounded value is generated.
- Overflow (O):
  - When rounding mode = RZ, the maximum normalized number, with the same sign as the unrounded value, is generated.
  - When rounding mode = RN, infinity with the same sign as the unrounded value is generated.
- Underflow (U):
  - When FPSCR.DN = 0, a denormalized number with the same sign as the unrounded value, or zero with the same sign as the unrounded value, is generated.
  - When FPSCR.DN = 1, zero with the same sign as the unrounded value, is generated.
- Inexact exception (I): An inexact result is generated.

## 6.6 Graphics Support Functions

The SH7750 supports two kinds of graphics functions: new instructions for geometric operations, and pair single-precision transfer instructions that enable high-speed data transfer.

### 6.6.1 Geometric Operation Instructions

Geometric operation instructions perform approximate-value computations. To enable high-speed computation with a minimum of hardware, the SH7750 ignores comparatively small values in the partial computation results of four multiplications. Consequently, the error shown below is produced in the result of the computation:

$$\text{Maximum error} = \text{MAX}(\text{individual multiplication result} \times 2^{-\text{MIN}(\text{number of multiplier significant digits}-1, \text{number of multiplicand significant digits}-1)}) + \text{MAX}(\text{result value} \times 2^{-23}, 2^{-149})$$

The number of significant digits is 24 for a normalized number and 23 for a denormalized number (number of leading zeros in the fractional part).

In future version of SH series, the above error is guaranteed, but the same result as SH7750 is not guaranteed.

**FIPR FVm, FVn (m, n: 0, 4, 8, 12):** This instruction is basically used for the following purposes:

- Inner product ( $m \neq n$ ):  
This operation is generally used for surface/rear surface determination for polygon surfaces.
- Sum of square of elements ( $m = n$ ):  
This operation is generally used to find the length of a vector.

Since approximate-value computations are performed to enable high-speed computation, the inexact exception (I) bit in the cause field and flag field is always set to 1 when an FIPR instruction is executed. Therefore, if the corresponding bit is set in the enable field, enable exception handling will be executed.

**FTRV XMTRX, FVn (n: 0, 4, 8, 12):** This instruction is basically used for the following purposes:

- Matrix ( $4 \times 4$ ) · vector (4):  
This operation is generally used for viewpoint changes, angle changes, or movements called vector transformations (4-dimensional). Since affine transformation processing for angle + parallel movement basically requires a  $4 \times 4$  matrix, the SH7750 supports 4-dimensional operations.
- Matrix ( $4 \times 4$ ) × matrix ( $4 \times 4$ ):  
This operation requires the execution of four FTRV instructions.

Since approximate-value computations are performed to enable high-speed computation, the inexact exception (I) bit in the cause field and flag field is always set to 1 when an FTRV instruction is executed. Therefore, if the corresponding bit is set in the enable field, enable exception handling will be executed. For the same reason, it is not possible to check all data types in the registers beforehand when executing an FTRV instruction. If the V bit is set in the enable field, enable exception handling will be executed.

**FRCHG:** This instruction modifies banked registers. For example, when the FTRV instruction is executed, matrix elements must be set in an array in the background bank. However, to create the actual elements of a translation matrix, it is easier to use registers in the foreground bank. When the LDC instruction is used on FPSCR, this instruction expends 4 to 5 cycles in order to maintain the FPU state. With the FRCHG instruction, an FPSCR.FR bit modification can be performed in one cycle.



### 6.6.2 Pair Single-Precision Data Transfer

In addition to the powerful new geometric operation instructions, the SH7750 also supports high-speed data transfer instructions.

When FPSCR.SZ = 1, the SH7750 can perform data transfer by means of pair single-precision data transfer instructions.

- FMOV DRm/XDm, DRn/XDRn (m, n: 0, 2, 4, 6, 8, 10, 12, 14)
- FMOV DRm/XDm, @Rn (m: 0, 2, 4, 6, 8, 10, 12, 14; n: 0 to 15)

These instructions enable two single-precision ( $2 \times 32$ -bit) data items to be transferred; that is, the transfer performance of these instructions is doubled.

- FSCHG  
This instruction changes the value of the SZ bit in FPSCR, enabling fast switching between use and non-use of pair single-precision data transfer.

# Section 7 Instruction Set

## 7.1 Execution Environment

**PC:** At the start of instruction execution, PC indicates the address of the instruction itself.

**Data sizes and data types:** The SH7750's instruction set is implemented with 16-bit fixed-length instructions. The SH7750 can use byte (8-bit), word (16-bit), longword (32-bit), and quadword (64-bit) data sizes for memory access. Single-precision floating-point data (32 bits) can be moved to and from memory using longword or quadword size. Double-precision floating-point data (64 bits) can be moved to and from memory using longword size. When a double-precision floating-point operation is specified (FPSCR.PR = 1), the result of an operation using quadword access will be undefined. When the SH7750 moves byte-size or word-size data from memory to a register, the data is sign-extended.

**Load-Store Architecture:** The SH7750 features a load-store architecture in which operations are basically executed using registers. Except for bit-manipulation operations such as logical AND that are executed directly in memory, operands in an operation that requires memory access are loaded into registers and the operation is executed between the registers.

**Delayed Branches:** Except for the two branch instructions BF and BT, the SH7750's branch instructions and RTE are delayed branches. In a delayed branch, the instruction following the branch is executed before the branch destination instruction. This execution slot following a delayed branch is called a delay slot. For example, the BRA execution sequence is as follows:

Static Sequence		Dynamic Sequence	
BRA	TARGET	BRA	TARGET
ADD	R1, R0 next_2	ADD	R1, R0 target_instr
		ADD in delay slot is executed before branching to TARGET	

**Delay Slot:** An illegal instruction exception may occur when a specific instruction is executed in a delay slot. See section 5, Exceptions. The instruction following BF/S or BT/S for which the branch is not taken is also a delay slot instruction.

**T Bit:** The T bit in the status register (SR) is used to show the result of a compare operation, and is referenced by a conditional branch instruction. An example of the use of a conditional branch instruction is shown below.

ADD #1, R0 ; T bit is not changed by ADD operation  
CMP/EQ R1, R0 ; If R0 = R1, T bit is set to 1  
BT TARGET ; Branches to TARGET if T bit = 1 (R0 = R1)

In an RTE delay slot, status register (SR) bits are referenced as follows. In instruction access, the MD bit is used before modification, and in data access, the MD bit is accessed after modification. The other bits—S, T, M, Q, FD, BL, and RB—after modification are used for delay slot instruction execution. The STC and STC.L SR instructions access all SR bits after modification.

**Constant Values:** An 8-bit constant value can be specified by the instruction code and an immediate value. 16-bit and 32-bit constant values can be defined as literal constant values in memory, and can be referenced by a PC-relative load instruction.

MOV.W @(disp, PC), Rn  
MOV.L @(disp, PC), Rn

There are no PC-relative load instructions for floating-point operations. However, it is possible to set 0.0 or 1.0 by using the FLDI0 or FLDI1 instruction on a single-precision floating-point register.

## 7.2 Addressing Modes

Addressing modes and effective address calculation methods are shown in table 7.1. When a location in virtual memory space is accessed (MMUCR.AT = 1), the effective address is translated into a physical memory address. If multiple virtual memory space systems are selected (MMUCR.SV = 0), the least significant bit of PTEH is also referenced as the access ASID. See section 3, Memory Management Unit (MMU).

**Table 7.1 Addressing Modes and Effective Addresses**

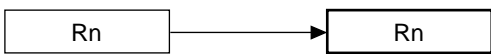
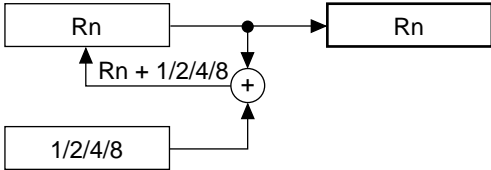
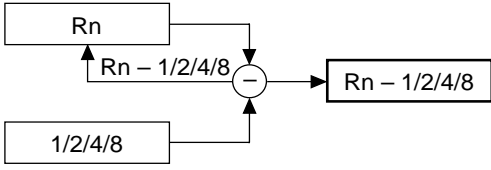
Addressing Mode	Instruction Format	Effective Address Calculation Method	Calculation Formula
Register direct	Rn	Effective address is register Rn. (Operand is register Rn contents.)	—
Register indirect	@Rn	Effective address is register Rn contents. 	Rn → EA (EA: effective address)
Register indirect with post-increment	@Rn+	Effective address is register Rn contents. A constant is added to Rn after instruction execution: 1 for a byte operand, 2 for a word operand, 4 for a longword operand, 8 for a quadword operand. 	Rn → EA After instruction execution Byte: Rn + 1 → Rn Word: Rn + 2 → Rn Longword: Rn + 4 → Rn Quadword: Rn + 8 → Rn
Register indirect with pre-decrement	@-Rn	Effective address is register Rn contents, decremented by a constant beforehand: 1 for a byte operand, 2 for a word operand, 4 for a longword operand, 8 for a quadword operand. 	Byte: Rn - 1 → Rn Word: Rn - 2 → Rn Longword: Rn - 4 → Rn Quadword: Rn - 8 → Rn Rn → EA (Instruction executed with Rn after calculation)

**Table 7.1 Addressing Modes and Effective Addresses (cont)**

Addressing Mode	Instruction Format	Effective Address Calculation Method	Calculation Formula
Register indirect with displacement	@(disp:4, Rn)	Effective address is register Rn contents with 4-bit displacement disp added. After disp is zero-extended, it is multiplied by 1 (byte), 2 (word), or 4 (longword), according to the operand size.	Byte: $Rn + disp \rightarrow EA$ Word: $Rn + disp \times 2 \rightarrow EA$ Longword: $Rn + disp \times 4 \rightarrow EA$
Indexed register indirect	@(R0, Rn)	Effective address is sum of register Rn and R0 contents.	$Rn + R0 \rightarrow EA$
GBR indirect with displacement	@(disp:8, GBR)	Effective address is register GBR contents with 8-bit displacement disp added. After disp is zero-extended, it is multiplied by 1 (byte), 2 (word), or 4 (longword), according to the operand size.	Byte: $GBR + disp \rightarrow EA$ Word: $GBR + disp \times 2 \rightarrow EA$ Longword: $GBR + disp \times 4 \rightarrow EA$
Indexed GBR indirect	@(R0, GBR)	Effective address is sum of register GBR and R0 contents.	$GBR + R0 \rightarrow EA$

**Table 7.1 Addressing Modes and Effective Addresses (cont)**

Addressing Mode	Instruction Format	Effective Address Calculation Method	Calculation Formula
PC-relative with displacement	@(disp:8, PC)	<p>Effective address is PC+4 with 8-bit displacement disp added. After disp is zero-extended, it is multiplied by 2 (word), or 4 (longword), according to the operand size. With a longword operand, the lower 2 bits of PC are masked.</p> <p style="text-align: right;">* With longword operand</p>	<p>Word: <math>PC + 4 + disp \times 2 \rightarrow EA</math></p> <p>Longword:  <math>PC \&amp; H'FFFFFFFC + 4 + disp \times 4 \rightarrow EA</math></p>
PC-relative	disp:8	<p>Effective address is PC+4 with 8-bit displacement disp added after being sign-extended and multiplied by 2.</p>	<p><math>PC + 4 + disp \times 2 \rightarrow \text{Branch-Target}</math></p>

**Table 7.1 Addressing Modes and Effective Addresses (cont)**

Addressing Mode	Instruction Format	Effective Address Calculation Method	Calculation Formula
PC-relative	disp:12	Effective address is PC+4 with 12-bit displacement disp added after being sign-extended and multiplied by 2.	$PC + 4 + \text{disp} \times 2 \rightarrow \text{Branch-Target}$
	Rn	Effective address is sum of PC+4 and Rn.	$PC + 4 + Rn \rightarrow \text{Branch-Target}$
Immediate	#imm:8	8-bit immediate data imm of TST, AND, OR, or XOR instruction is zero-extended.	—
	#imm:8	8-bit immediate data imm of MOV, ADD, or CMP/EQ instruction is sign-extended.	—
	#imm:8	8-bit immediate data imm of TRAPA instruction is zero-extended and multiplied by 4.	—

Note: For the addressing modes below that use a displacement (disp), the assembler descriptions in this manual show the value before scaling ( $\times 1$ ,  $\times 2$ , or  $\times 4$ ) is performed according to the operand size. This is done to clarify the operation of the chip. Refer to the relevant assembler notation rules for the actual assembler descriptions.

- @ (disp:4, Rn) ; Register indirect with displacement
- @ (disp:8, GBR) ; GBR indirect with displacement
- @ (disp:8, PC) ; PC-relative with displacement
- disp:8, disp:12 ; PC-relative

## 7.3 Instruction Set

Table 7.2 shows the notation used in the following SH instruction list.

**Table 7.2 Notation Used in Instruction List**

Item	Format	Description
Instruction mnemonic	OP.Sz SRC, DEST	OP: Operation code Sz: Size SRC: Source DEST: Source and/or destination operand
Summary of operation		→, ← Transfer direction (xx) Memory operand M/Q/T SR flag bits & Logical AND of individual bits   Logical OR of individual bits ^ Logical exclusive-OR of individual bits ~ Logical NOT of individual bits <<n, >>n n-bit shift
Instruction code	MSB ↔ LSB	m m m m: Register number (Rm, FRm) n n n n: Register number (Rn, FRn) 0000: R0, FR0 0001: R1, FR1 : 1111: R15, FR15 m m m: Register number (DRm, XDm, Rm_BANK) n n n: Register number (DRm, XDm, Rn_BANK) 000: DR0, XD0, R0_BANK 001: DR2, XD2, R1_BANK : 111: DR14, XD14, R7_BANK m m: Register number (FVm) n n: Register number (FVn) 00: FV0 01: FV4 10: FV8 11: FV12 i i i i: Immediate data d d d d: Displacement
Privileged mode		"Privileged" means the instruction can only be executed in privileged mode.
T bit	Value of T bit after instruction execution	—: No change

Note: Scaling (×1, ×2, ×4, or ×8) is executed according to the size of the instruction operand(s).



**Table 7.3 Fixed-Point Transfer Instructions**

Instruction	Operation	Instruction Code	Privileged	T Bit
MOV #imm,Rn	imm → sign extension → Rn	1110nnnniiiiiii	—	—
MOV.W @(disp,PC),Rn	(disp × 2 + PC + 4) → sign extension → Rn	1001nnnnddddddd	—	—
MOV.L @(disp,PC),Rn	(disp × 4 + PC & H'FFFFFFC + 4) → Rn	1101nnnnddddddd	—	—
MOV Rm,Rn	Rm → Rn	0110nnnnmmmm0011	—	—
MOV.B Rm,@Rn	Rm → (Rn)	0010nnnnmmmm0000	—	—
MOV.W Rm,@Rn	Rm → (Rn)	0010nnnnmmmm0001	—	—
MOV.L Rm,@Rn	Rm → (Rn)	0010nnnnmmmm0010	—	—
MOV.B @Rm,Rn	(Rm) → sign extension → Rn	0110nnnnmmmm0000	—	—
MOV.W @Rm,Rn	(Rm) → sign extension → Rn	0110nnnnmmmm0001	—	—
MOV.L @Rm,Rn	(Rm) → Rn	0110nnnnmmmm0010	—	—
MOV.B Rm,@-Rn	Rn-1 → Rn, Rm → (Rn)	0010nnnnmmmm0100	—	—
MOV.W Rm,@-Rn	Rn-2 → Rn, Rm → (Rn)	0010nnnnmmmm0101	—	—
MOV.L Rm,@-Rn	Rn-4 → Rn, Rm → (Rn)	0010nnnnmmmm0110	—	—
MOV.B @Rm+,Rn	(Rm) → sign extension → Rn, Rm + 1 → Rm	0110nnnnmmmm0100	—	—
MOV.W @Rm+,Rn	(Rm) → sign extension → Rn, Rm + 2 → Rm	0110nnnnmmmm0101	—	—
MOV.L @Rm+,Rn	(Rm) → Rn, Rm + 4 → Rm	0110nnnnmmmm0110	—	—
MOV.B R0,@(disp,Rn)	R0 → (disp + Rn)	10000000nnnnddd	—	—
MOV.W R0,@(disp,Rn)	R0 → (disp × 2 + Rn)	10000001nnnnddd	—	—
MOV.L Rm,@(disp,Rn)	Rm → (disp × 4 + Rn)	0001nnnnmmmmddd	—	—
MOV.B @(disp,Rm),R0	(disp + Rm) → sign extension → R0	10000100mmmmddd	—	—
MOV.W @(disp,Rm),R0	(disp × 2 + Rm) → sign extension → R0	10000101mmmmddd	—	—
MOV.L @(disp,Rm),Rn	(disp × 4 + Rm) → Rn	0101nnnnmmmmddd	—	—
MOV.B Rm,@(R0,Rn)	Rm → (R0 + Rn)	0000nnnnmmmm0100	—	—
MOV.W Rm,@(R0,Rn)	Rm → (R0 + Rn)	0000nnnnmmmm0101	—	—
MOV.L Rm,@(R0,Rn)	Rm → (R0 + Rn)	0000nnnnmmmm0110	—	—
MOV.B @(R0,Rm),Rn	(R0 + Rm) → sign extension → Rn	0000nnnnmmmm1100	—	—
MOV.W @(R0,Rm),Rn	(R0 + Rm) → sign extension → Rn	0000nnnnmmmm1101	—	—
MOV.L @(R0,Rm),Rn	(R0 + Rm) → Rn	0000nnnnmmmm1110	—	—

**Table 7.3 Fixed-Point Transfer Instructions (cont)**

Instruction	Operation	Instruction Code	Privileged	T Bit
MOV.B	R0,@(disp,GBR) R0 → (disp + GBR)	11000000dddddddd	—	—
MOV.W	R0,@(disp,GBR) R0 → (disp × 2 + GBR)	11000001dddddddd	—	—
MOV.L	R0,@(disp,GBR) R0 → (disp × 4 + GBR)	11000010dddddddd	—	—
MOV.B	@(disp,GBR),R0 (disp + GBR) → sign extension → R0	11000100dddddddd	—	—
MOV.W	@(disp,GBR),R0 (disp × 2 + GBR) → sign extension → R0	11000101dddddddd	—	—
MOV.L	@(disp,GBR),R0 (disp × 4 + GBR) → R0	11000110dddddddd	—	—
MOVA	@(disp,PC),R0 disp × 4 + PC & H'FFFFFFC + 4 → R0	11000111dddddddd	—	—
MOVT	Rn T → Rn	0000nnnn00101001	—	—
SWAP.B	Rm,Rn Rm → swap lower 2 bytes → Rn	0110nnnnmmmm1000	—	—
SWAP.W	Rm,Rn Rm → swap upper/lower words → Rn	0110nnnnmmmm1001	—	—
XTRCT	Rm,Rn Rm:Rn middle 32 bits → Rn	0010nnnnmmmm1101	—	—

**Table 7.4 Arithmetic Operation Instructions**

Instruction		Operation	Instruction Code	Privileged	T Bit
ADD	Rm,Rn	$Rn + Rm \rightarrow Rn$	0011nnnnmmmm1100	—	—
ADD	#imm,Rn	$Rn + imm \rightarrow Rn$	0111nnnniiiiiii	—	—
ADDC	Rm,Rn	$Rn + Rm + T \rightarrow Rn$ , carry $\rightarrow T$	0011nnnnmmmm1110	—	Carry
ADDV	Rm,Rn	$Rn + Rm \rightarrow Rn$ , overflow $\rightarrow T$	0011nnnnmmmm1111	—	Overflow
CMP/EQ	#imm,R0	When R0 = imm, 1 $\rightarrow T$ Otherwise, 0 $\rightarrow T$	10001000iiiiiii	—	Comparison result
CMP/EQ	Rm,Rn	When Rn = Rm, 1 $\rightarrow T$ Otherwise, 0 $\rightarrow T$	0011nnnnmmmm0000	—	Comparison result
CMP/HS	Rm,Rn	When Rn $\geq$ Rm (unsigned), 1 $\rightarrow T$ Otherwise, 0 $\rightarrow T$	0011nnnnmmmm0010	—	Comparison result
CMP/GE	Rm,Rn	When Rn $\geq$ Rm (signed), 1 $\rightarrow T$ Otherwise, 0 $\rightarrow T$	0011nnnnmmmm0011	—	Comparison result
CMP/HI	Rm,Rn	When Rn > Rm (unsigned), 1 $\rightarrow T$ Otherwise, 0 $\rightarrow T$	0011nnnnmmmm0110	—	Comparison result
CMP/GT	Rm,Rn	When Rn > Rm (signed), 1 $\rightarrow T$ Otherwise, 0 $\rightarrow T$	0011nnnnmmmm0111	—	Comparison result
CMP/PZ	Rn	When Rn $\geq$ 0, 1 $\rightarrow T$ Otherwise, 0 $\rightarrow T$	0100nnnn00010001	—	Comparison result
CMP/PL	Rn	When Rn > 0, 1 $\rightarrow T$ Otherwise, 0 $\rightarrow T$	0100nnnn00010101	—	Comparison result
CMP/STR	Rm,Rn	When any bytes are equal, 1 $\rightarrow T$ Otherwise, 0 $\rightarrow T$	0010nnnnmmmm1100	—	Comparison result
DIV1	Rm,Rn	1-step division ( $Rn \div Rm$ )	0011nnnnmmmm0100	—	Calculation result
DIV0S	Rm,Rn	MSB of Rn $\rightarrow Q$ , MSB of Rm $\rightarrow M$ , $M^Q \rightarrow T$	0010nnnnmmmm0111	—	Calculation result
DIV0U		0 $\rightarrow M/Q/T$	0000000000011001	—	0
DMULS.L	Rm,Rn	Signed, $Rn \times Rm \rightarrow MAC$ , $32 \times 32 \rightarrow 64$ bits	0011nnnnmmmm1101	—	—
DMULU.L	Rm,Rn	Unsigned, $Rn \times Rm \rightarrow MAC$ , $32 \times 32 \rightarrow 64$ bits	0011nnnnmmmm0101	—	—
DT	Rn	$Rn - 1 \rightarrow Rn$ ; when Rn = 0, 1 $\rightarrow T$ When Rn $\neq$ 0, 0 $\rightarrow T$	0100nnnn00010000	—	Comparison result
EXTS.B	Rm,Rn	Rm sign-extended from byte $\rightarrow Rn$	0110nnnnmmmm1110	—	—

**Table 7.4 Arithmetic Operation Instructions (cont)**

Instruction		Operation	Instruction Code	Privileged	T Bit
EXTS.W	Rm,Rn	Rm sign-extended from word → Rn	0110nnnnnnmmmm1111	—	—
EXTU.B	Rm,Rn	Rm zero-extended from byte → Rn	0110nnnnnnmmmm1100	—	—
EXTU.W	Rm,Rn	Rm zero-extended from word → Rn	0110nnnnnnmmmm1101	—	—
MAC.L	@Rm+,@Rn+	Signed, (Rn) × (Rm) + MAC → MAC Rn + 4 → Rn, Rm + 4 → Rm 32 × 32 + 64 → 64 bits	0000nnnnnnmmmm1111	—	—
MAC.W	@Rm+,@Rn+	Signed, (Rn) × (Rm) + MAC → MAC Rn + 2 → Rn, Rm + 2 → Rm 16 × 16 + 64 → 64 bits	0100nnnnnnmmmm1111	—	—
MUL.L	Rm,Rn	Rn × Rm → MACL 32 × 32 → 32 bits	0000nnnnnnmmmm0111	—	—
MULS.W	Rm,Rn	Signed, Rn × Rm → MACL 16 × 16 → 32 bits	0010nnnnnnmmmm1111	—	—
MULU.W	Rm,Rn	Unsigned, Rn × Rm → MACL 16 × 16 → 32 bits	0010nnnnnnmmmm1110	—	—
NEG	Rm,Rn	0 – Rm → Rn	0110nnnnnnmmmm1011	—	—
NEGC	Rm,Rn	0 – Rm – T → Rn, borrow → T	0110nnnnnnmmmm1010	—	Borrow
SUB	Rm,Rn	Rn – Rm → Rn	0011nnnnnnmmmm1000	—	—
SUBC	Rm,Rn	Rn – Rm – T → Rn, borrow → T	0011nnnnnnmmmm1010	—	Borrow
SUBV	Rm,Rn	Rn – Rm → Rn, underflow → T	0011nnnnnnmmmm1011	—	Underflow

**Table 7.5 Logic Operation Instructions**

Instruction	Operation	Instruction Code	Privileged	T Bit
AND Rm,Rn	$Rn \& Rm \rightarrow Rn$	0010nnnnmmmm1001	—	—
AND #imm,R0	$R0 \& imm \rightarrow R0$	11001001iiiiiii	—	—
AND.B #imm,@(R0,GBR)	$(R0 + GBR) \& imm \rightarrow (R0 + GBR)$	11001101iiiiiii	—	—
NOT Rm,Rn	$\sim Rm \rightarrow Rn$	0110nnnnmmmm0111	—	—
OR Rm,Rn	$Rn   Rm \rightarrow Rn$	0010nnnnmmmm1011	—	—
OR #imm,R0	$R0   imm \rightarrow R0$	11001011iiiiiii	—	—
OR.B #imm,@(R0,GBR)	$(R0 + GBR)   imm \rightarrow (R0 + GBR)$	11001111iiiiiii	—	—
TAS.B @Rn	When (Rn) = 0, 1 → T Otherwise, 0 → T In both cases, 1 → MSB of (Rn)	0100nnnn00011011	—	Test result
TST Rm,Rn	$Rn \& Rm$ ; when result = 0, 1 → T Otherwise, 0 → T	0010nnnnmmmm1000	—	Test result
TST #imm,R0	$R0 \& imm$ ; when result = 0, 1 → T Otherwise, 0 → T	11001000iiiiiii	—	Test result
TST.B #imm,@(R0,GBR)	$(R0 + GBR) \& imm$ ; when result = 0, 1 → T Otherwise, 0 → T	11001100iiiiiii	—	Test result
XOR Rm,Rn	$Rn \wedge Rm \rightarrow Rn$	0010nnnnmmmm1010	—	—
XOR #imm,R0	$R0 \wedge imm \rightarrow R0$	11001010iiiiiii	—	—
XOR.B #imm,@(R0,GBR)	$(R0 + GBR) \wedge imm \rightarrow (R0 + GBR)$	11001110iiiiiii	—	—

**Table 7.6 Shift Instructions**

Instruction		Operation	Instruction Code	Privileged	T Bit
ROTL	Rn	$T \leftarrow Rn \leftarrow \text{MSB}$	0100nnnn00000100	—	MSB
ROTR	Rn	$\text{LSB} \rightarrow Rn \rightarrow T$	0100nnnn00000101	—	LSB
ROTCL	Rn	$T \leftarrow Rn \leftarrow T$	0100nnnn00100100	—	MSB
ROTCR	Rn	$T \rightarrow Rn \rightarrow T$	0100nnnn00100101	—	LSB
SHAD	Rm,Rn	When $Rn \geq 0$ , $Rn \ll Rm \rightarrow Rn$ When $Rn < 0$ , $Rn \gg Rm \rightarrow$ [MSB $\rightarrow Rn$ ]	0100nnnnmmmm1100	—	—
SHAL	Rn	$T \leftarrow Rn \leftarrow 0$	0100nnnn00100000	—	MSB
SHAR	Rn	$\text{MSB} \rightarrow Rn \rightarrow T$	0100nnnn00100001	—	LSB
SHLD	Rm,Rn	When $Rn \geq 0$ , $Rn \ll Rm \rightarrow Rn$ When $Rn < 0$ , $Rn \gg Rm \rightarrow$ [0 $\rightarrow Rn$ ]	0100nnnnmmmm1101	—	—
SHLL	Rn	$T \leftarrow Rn \leftarrow 0$	0100nnnn00000000	—	MSB
SHLR	Rn	$0 \rightarrow Rn \rightarrow T$	0100nnnn00000001	—	LSB
SHLL2	Rn	$Rn \ll 2 \rightarrow Rn$	0100nnnn00001000	—	—
SHLR2	Rn	$Rn \gg 2 \rightarrow Rn$	0100nnnn00001001	—	—
SHLL8	Rn	$Rn \ll 8 \rightarrow Rn$	0100nnnn00011000	—	—
SHLR8	Rn	$Rn \gg 8 \rightarrow Rn$	0100nnnn00011001	—	—
SHLL16	Rn	$Rn \ll 16 \rightarrow Rn$	0100nnnn00101000	—	—
SHLR16	Rn	$Rn \gg 16 \rightarrow Rn$	0100nnnn00101001	—	—

**Table 7.7 Branch Instructions**

Instruction		Operation	Instruction Code	Privileged	T Bit
BF	label	When T = 0, $\text{disp} \times 2 + \text{PC} + 4 \rightarrow \text{PC}$ When T = 1, nop	10001011dddddddd	—	—
BF/S	label	Delayed branch; when T = 0, $\text{disp} \times 2 + \text{PC} + 4 \rightarrow \text{PC}$ When T = 1, nop	10001111dddddddd	—	—
BT	label	When T = 1, $\text{disp} \times 2 + \text{PC} + 4 \rightarrow \text{PC}$ When T = 0, nop	10001001dddddddd	—	—
BT/S	label	Delayed branch; when T = 1, $\text{disp} \times 2 + \text{PC} + 4 \rightarrow \text{PC}$ When T = 0, nop	10001101dddddddd	—	—
BRA	label	Delayed branch, $\text{disp} \times 2 + \text{PC} + 4 \rightarrow \text{PC}$	1010dddddddddddd	—	—
BRAF	Rn	$\text{Rn} + \text{PC} + 4 \rightarrow \text{PC}$	0000nmmn00100011	—	—
BSR	label	Delayed branch, $\text{PC} + 4 \rightarrow \text{PR}$ , $\text{disp} \times 2 + \text{PC} + 4 \rightarrow \text{PC}$	1011dddddddddddd	—	—
BSRF	Rn	Delayed branch, $\text{PC} + 4 \rightarrow \text{PR}$ , $\text{Rn} + \text{PC} + 4 \rightarrow \text{PC}$	0000nmmn00000011	—	—
JMP	@Rn	Delayed branch, $\text{Rn} \rightarrow \text{PC}$	0100nmmn00101011	—	—
JSR	@Rn	Delayed branch, $\text{PC} + 4 \rightarrow \text{PR}$ , $\text{Rn} \rightarrow \text{PC}$	0100nmmn00001011	—	—
RTS		Delayed branch, $\text{PR} \rightarrow \text{PC}$	0000000000001011	—	—

**Table 7.8 System Control Instructions**

Instruction	Operation	Instruction Code	Privileged	T Bit
CLRMACH	0 → MACH, MACL	000000000101000	—	—
CLRS	0 → S	000000001001000	—	—
CLRT	0 → T	000000000001000	—	0
LDC Rm,SR	Rm → SR	0100mmmm00001110	Privileged	LSB
LDC Rm,GBR	Rm → GBR	0100mmmm00011110	—	—
LDC Rm,VBR	Rm → VBR	0100mmmm00101110	Privileged	—
LDC Rm,SSR	Rm → SSR	0100mmmm00111110	Privileged	—
LDC Rm,SPC	Rm → SPC	0100mmmm01001110	Privileged	—
LDC Rm,DBR	Rm → DBR	0100mmmm111101010	Privileged	—
LDC Rm,Rn_BANK	Rm → Rn_BANK (n = 0 to 7)	0100mmmm1nnn1110	Privileged	—
LDC.L @Rm+,SR	(Rm) → SR, Rm + 4 → Rm	0100mmmm00000111	Privileged	LSB
LDC.L @Rm+,GBR	(Rm) → GBR, Rm + 4 → Rm	0100mmmm00010111	—	—
LDC.L @Rm+,VBR	(Rm) → VBR, Rm + 4 → Rm	0100mmmm00100111	Privileged	—
LDC.L @Rm+,SSR	(Rm) → SSR, Rm + 4 → Rm	0100mmmm00110111	Privileged	—
LDC.L @Rm+,SPC	(Rm) → SPC, Rm + 4 → Rm	0100mmmm01000111	Privileged	—
LDC.L @Rm+,DBR	(Rm) → DBR, Rm + 4 → Rm	0100mmmm11110110	Privileged	—
LDC.L @Rm+,Rn_BANK	(Rm) → Rn_BANK, Rm + 4 → Rm	0100mmmm1nnn0111	Privileged	—
LDS Rm,MACH	Rm → MACH	0100mmmm00001010	—	—
LDS Rm,MACL	Rm → MACL	0100mmmm00011010	—	—
LDS Rm,PR	Rm → PR	0100mmmm00101010	—	—
LDS.L @Rm+,MACH	(Rm) → MACH, Rm + 4 → Rm	0100mmmm00000110	—	—
LDS.L @Rm+,MACL	(Rm) → MACL, Rm + 4 → Rm	0100mmmm00010110	—	—
LDS.L @Rm+,PR	(Rm) → PR, Rm + 4 → Rm	0100mmmm00100110	—	—
LDTLB	PTEH/PTEL → TLB	000000000111000	Privileged	—
MOVCA.L R0,@Rn	R0 → (Rn) (without fetching cache block)	0000nnnn11000011	—	—
NOP	No operation	000000000001001	—	—
OCBI @Rn	Invalidates operand cache block	0000nnnn10010011	—	—
OCBP @Rn	Writes back and invalidates operand cache block	0000nnnn10100011	—	—
OCBWB @Rn	Writes back operand cache block	0000nnnn10110011	—	—
PREF @Rn	(Rn) → operand cache	0000nnnn10000011	—	—
RTE	Delayed branch, SSR/SPC → SR/PC	000000000101011	Privileged	—



**Table 7.8 System Control Instructions (cont)**

Instruction	Operation	Instruction Code	Privileged	T Bit	
SETS	1 → S	0000000001011000	—	—	
SETT	1 → T	0000000000011000	—	1	
SLEEP	Sleep or standby	0000000000011011	Privileged	—	
STC	SR,Rn	SR → Rn	0000nnnn00000010	Privileged	—
STC	GBR,Rn	GBR → Rn	0000nnnn00010010	—	—
STC	VBR,Rn	VBR → Rn	0000nnnn00100010	Privileged	—
STC	SSR,Rn	SSR → Rn	0000nnnn00110010	Privileged	—
STC	SPC,Rn	SPC → Rn	0000nnnn01000010	Privileged	—
STC	SGR,Rn	SGR → Rn	0000nnnn00111010	Privileged	—
STC	DBR,Rn	DBR → Rn	0000nnnn11111010	Privileged	—
STC	Rm_BANK,Rn	Rm_BANK → Rn (m = 0 to 7)	0000nnnn1mmm0010	Privileged	—
STC.L	SR,@-Rn	Rn - 4 → Rn, SR → (Rn)	0100nnnn00000011	Privileged	—
STC.L	GBR,@-Rn	Rn - 4 → Rn, GBR → (Rn)	0100nnnn00010011	—	—
STC.L	VBR,@-Rn	Rn - 4 → Rn, VBR → (Rn)	0100nnnn00100011	Privileged	—
STC.L	SSR,@-Rn	Rn - 4 → Rn, SSR → (Rn)	0100nnnn00110011	Privileged	—
STC.L	SPC,@-Rn	Rn - 4 → Rn, SPC → (Rn)	0100nnnn01000011	Privileged	—
STC.L	SGR,@-Rn	Rn - 4 → Rn, SGR → (Rn)	0100nnnn00110010	Privileged	—
STC.L	DBR,@-Rn	Rn - 4 → Rn, DBR → (Rn)	0100nnnn11110010	Privileged	—
STC.L	Rm_BANK,@-Rn	Rn - 4 → Rn, Rm_BANK → (Rn) (m = 0 to 7)	0100nnnn1mmm0011	Privileged	—
STS	MACH,Rn	MACH → Rn	0000nnnn00001010	—	—
STS	MACL,Rn	MACL → Rn	0000nnnn00011010	—	—
STS	PR,Rn	PR → Rn	0000nnnn00101010	—	—
STS.L	MACH,@-Rn	Rn - 4 → Rn, MACH → (Rn)	0100nnnn00000010	—	—
STS.L	MACL,@-Rn	Rn - 4 → Rn, MACL → (Rn)	0100nnnn00010010	—	—
STS.L	PR,@-Rn	Rn - 4 → Rn, PR → (Rn)	0100nnnn00100010	—	—
TRAPA	#imm	PC + 2 → SPC, SR → SSR, #imm << 2 → TRA, H'160 → EXPEVT, VBR + H'0100 → PC	11000011iiiiiiii	—	—

**Table 7.9 Floating-Point Single-Precision Instructions**

Instruction	Operation	Instruction Code	Privileged	T Bit
FLDI0	FRn	H'00000000 → FRn	1111nnnn10001101	—
FLDI1	FRn	H'3F800000 → FRn	1111nnnn10011101	—
FMOV	FRm,FRn	FRm → FRn	1111nnnnmmmm1100	—
FMOV.S	@Rm,FRn	(Rm) → FRn	1111nnnnmmmm1000	—
FMOV.S	@(R0,Rm),FRn	(R0 + Rm) → FRn	1111nnnnmmmm0110	—
FMOV.S	@Rm+,FRn	(Rm) → FRn, Rm + 4 → Rm	1111nnnnmmmm1001	—
FMOV.S	FRm,@Rn	FRm → (Rn)	1111nnnnmmmm1010	—
FMOV.S	FRm,@-Rn	Rn-4 → Rn, FRm → (Rn)	1111nnnnmmmm1011	—
FMOV.S	FRm,@(R0,Rn)	FRm → (R0 + Rn)	1111nnnnmmmm0111	—
FMOV	DRm,DRn	DRm → DRn	1111nnn0mmmm01100	—
FMOV	@Rm,DRn	(Rm) → DRn	1111nnn0mmmm1000	—
FMOV	@(R0,Rm),DRn	(R0 + Rm) → DRn	1111nnn0mmmm0110	—
FMOV	@Rm+,DRn	(Rm) → DRn, Rm + 8 → Rm	1111nnn0mmmm1001	—
FMOV	DRm,@Rn	DRm → (Rn)	1111nnnnmmmm01010	—
FMOV	DRm,@-Rn	Rn-8 → Rn, DRm → (Rn)	1111nnnnmmmm01011	—
FMOV	DRm,@(R0,Rn)	DRm → (R0 + Rn)	1111nnnnmmmm00111	—
FLDS	FRm,FPUL	FRm → FPUL	1111mmmm00011101	—
FSTS	FPUL,FRn	FPUL → FRn	1111nnnn00001101	—
FABS	FRn	FRn & H'7FFF FFFF → FRn	1111nnnn01011101	—
FADD	FRm,FRn	FRn + FRm → FRn	1111nnnnmmmm0000	—
FCMP/EQ	FRm,FRn	When FRn = FRm, 1 → T Otherwise, 0 → T	1111nnnnmmmm0100	—
FCMP/GT	FRm,FRn	When FRn > FRm, 1 → T Otherwise, 0 → T	1111nnnnmmmm0101	—
FDIV	FRm,FRn	FRn/FRm → FRn	1111nnnnmmmm0011	—
FLOAT	FPUL,FRn	(float) FPUL → FRn	1111nnnn00101101	—
FMAC	FR0,FRm,FRn	FR0*FRm + FRn → FRn	1111nnnnmmmm1110	—
FMUL	FRm,FRn	FRn*FRm → FRn	1111nnnnmmmm0010	—
FNEG	FRn	FRn ^ H'80000000 → FRn	1111nnnn01001101	—
FSQRT	FRn	√FRn → FRn	1111nnnn01101101	—
FSUB	FRm,FRn	FRn - FRm → FRn	1111nnnnmmmm0001	—
FTRC	FRm,FPUL	(long) FRm → FPUL	1111mmmm00111101	—

**Table 7.10 Floating-Point Double-Precision Instructions**

Instruction		Operation	Instruction Code	Privileged	T Bit
FABS	DRn	DRn & H'7FFF FFFF FFFF FFFF → DRn	1111nnn001011101	—	—
FADD	DRm,DRn	DRn + DRm → DRn	1111nnn0mmm00000	—	—
FCMP/EQ	DRm,DRn	When DRn = DRm, 1 → T Otherwise, 0 → T	1111nnn0mmm00100	—	Comparison result
FCMP/GT	DRm,DRn	When DRn > DRm, 1 → T Otherwise, 0 → T	1111nnn0mmm00101	—	Comparison result
FDIV	DRm,DRn	DRn /DRm → DRn	1111nnn0mmm00011	—	—
FCNVDS	DRm,FPUL	double_to_float[DRm] → FPUL	1111mmm01011101	—	—
FCNVSD	FPUL,DRn	float_to_double [FPUL] → DRn	1111nnn010101101	—	—
FLOAT	FPUL,DRn	(float)FPUL → DRn	1111nnn000101101	—	—
FMUL	DRm,DRn	DRn *DRm → DRn	1111nnn0mmm00010	—	—
FNEG	DRn	DRn ^ H'8000 0000 0000 0000 → DRn	1111nnn001001101	—	—
FSQRT	DRn	$\sqrt{\text{DRn}}$ → DRn	1111nnn001101101	—	—
FSUB	DRm,DRn	DRn – DRm → DRn	1111nnn0mmm00001	—	—
FTRC	DRm,FPUL	(long) DRm → FPUL	1111mmm000111101	—	—

**Table 7.11 Floating-Point Control Instructions**

Instruction		Operation	Instruction Code	Privileged	T Bit
LDS	Rm,FPSCR	Rm → FPSCR	0100mmmm01101010	—	—
LDS	Rm,FPUL	Rm → FPUL	0100mmmm01011010	—	—
LDS.L	@Rm+,FPSCR	(Rm) → FPSCR, Rm+4 → Rm	0100mmmm01100110	—	—
LDS.L	@Rm+,FPUL	(Rm) → FPUL, Rm+4 → Rm	0100mmmm01010110	—	—
STS	FPSCR,Rn	FPSCR → Rn	0000nnnn01101010	—	—
STS	FPUL,Rn	FPUL → Rn	0000nnnn01011010	—	—
STS.L	FPSCR,@-Rn	Rn – 4 → Rn, FPSCR → (Rn)	0100nnnn01100010	—	—
STS.L	FPUL,@-Rn	Rn – 4 → Rn, FPUL → (Rn)	0100nnnn01010010	—	—

**Table 7.12 Floating-Point Graphics Acceleration Instructions**

Instruction	Operation	Instruction Code	Privileged	T Bit
FMOV DRm,XDn	DRm → XDn	1111nnn1mmm01100	—	—
FMOV XDm,DRn	XDm → DRn	1111nnn0mmm11100	—	—
FMOV XDm,XDn	XDm → XDn	1111nnn1mmm11100	—	—
FMOV @Rm,XDn	(Rm) → XDn	1111nnn1mmm1000	—	—
FMOV @Rm+,XDn	(Rm) → XDn, Rm + 8 → Rm	1111nnn1mmm1001	—	—
FMOV @(R0,Rm),DRn	(R0 + Rm) → DRn	1111nnn1mmm0110	—	—
FMOV XDm,@Rn	XDm → (Rn)	1111nnnnmmm11010	—	—
FMOV XDm,@-Rn	Rn - 8 → Rn, XDm → (Rn)	1111nnnnmmm11011	—	—
FMOV XDm,@(R0,Rn)	XDm → (R0+Rn)	1111nnnnmmm10111	—	—
FIPR FVm,FVn	inner_product [FVm, FVn] → FR[n+3]	1111nnmm11101101	—	—
FTRV XMTRX,FVn	transform_vector [XMTRX, FVn] → FVn	1111nn0111111101	—	—
FRCHG	~FPSCR.FR → SPFCR.FR	1111101111111101	—	—
FSCHG	~FPSCR.SZ → SPFCR.SZ	1111001111111101	—	—

## Section 8 Pipelining

The SH7750 is a 2-ILP (instruction-level-parallelism) superscalar pipelining microprocessor. Instruction execution is pipelined, and two instructions can be executed in parallel. The execution cycles depend on the implementation of a processor. Definitions in this section may not be applicable to SH-4 Series models other than the SH7750.

### 8.1 Pipelines

Figure 8.1 shows the basic pipelines. Normally, a pipeline consists of five or six stages: instruction fetch (I), decode and register read (D), execution (EX/SX/F0/F1/F2/F3), data access (NA/MA), and write-back (S/FS). An instruction is executed as a combination of basic pipelines. Figure 8.2 shows the instruction execution patterns.

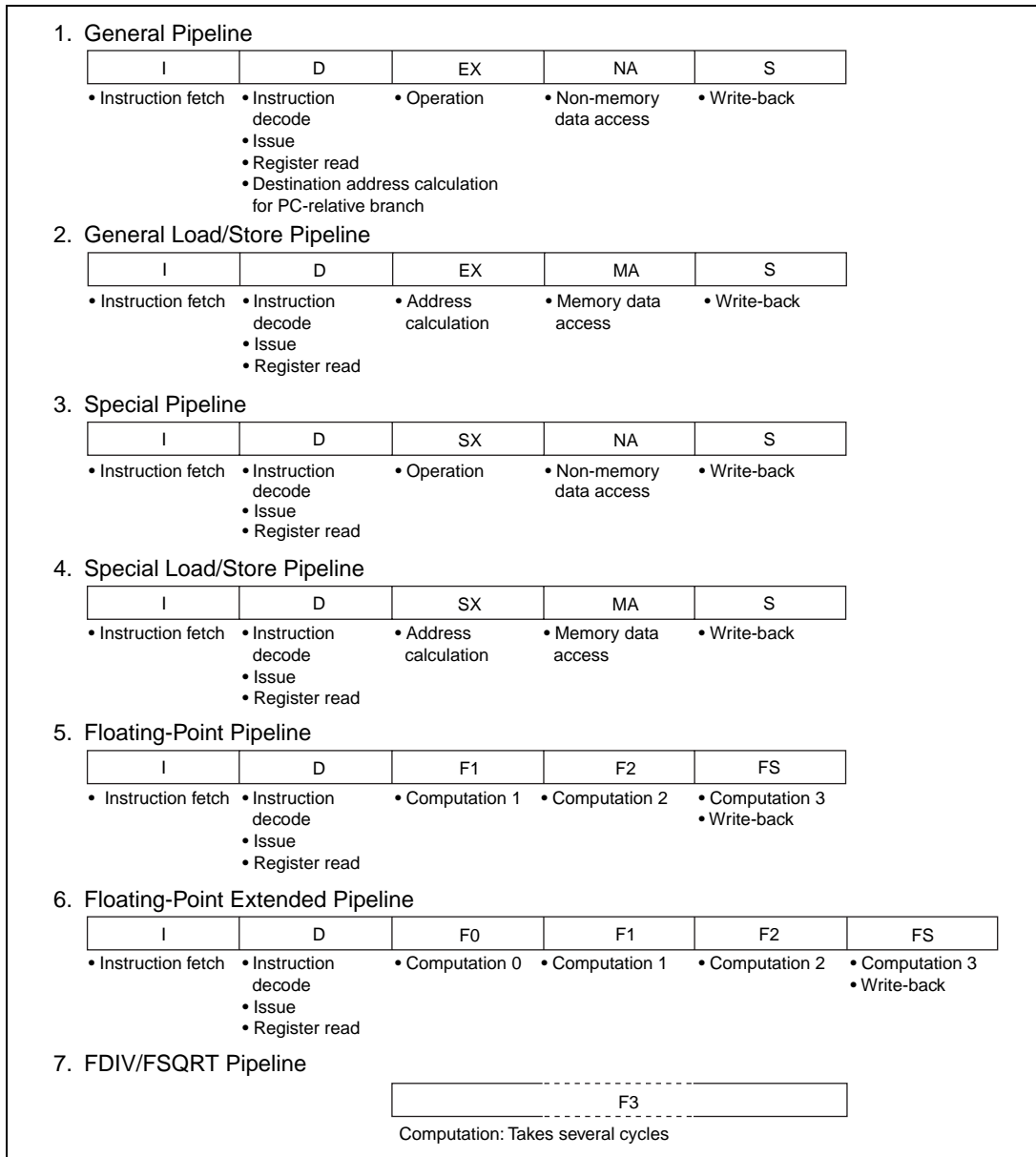

Figure 8.1 Basic Pipelines

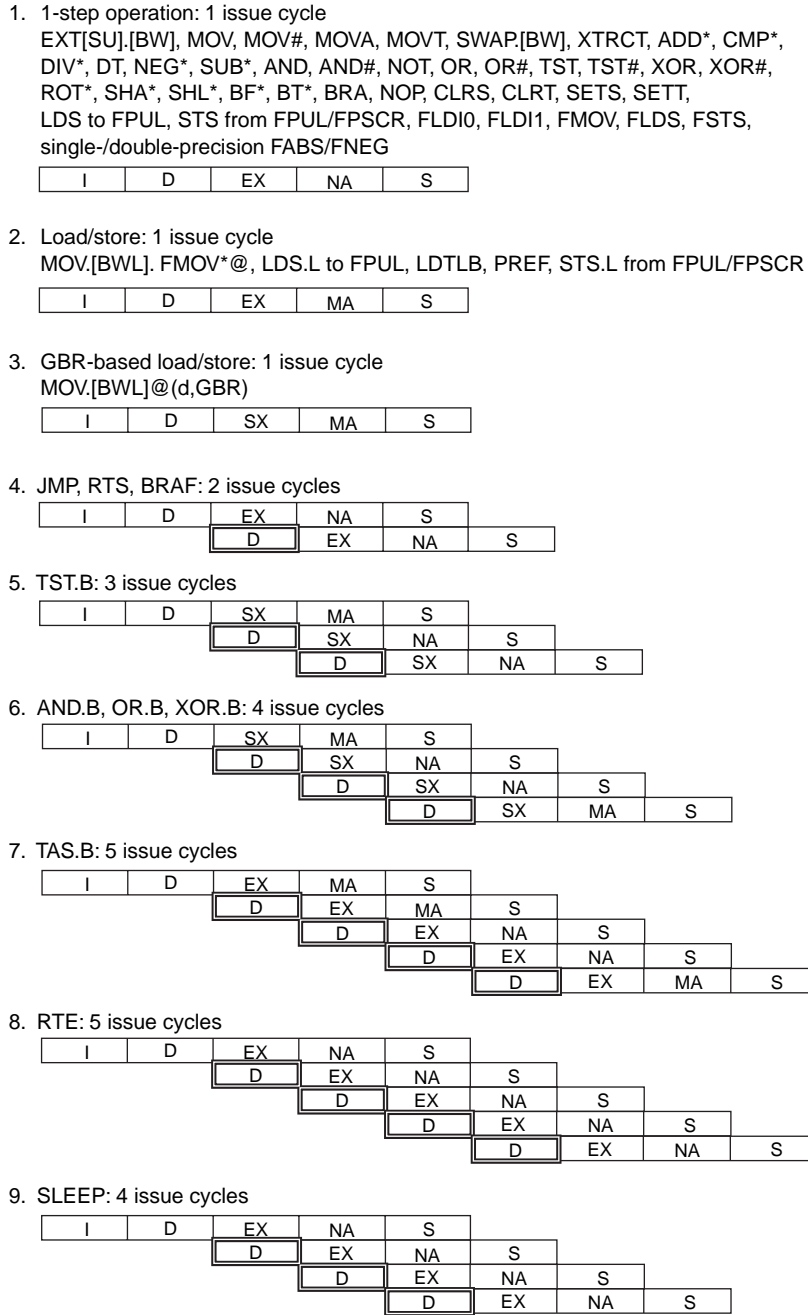
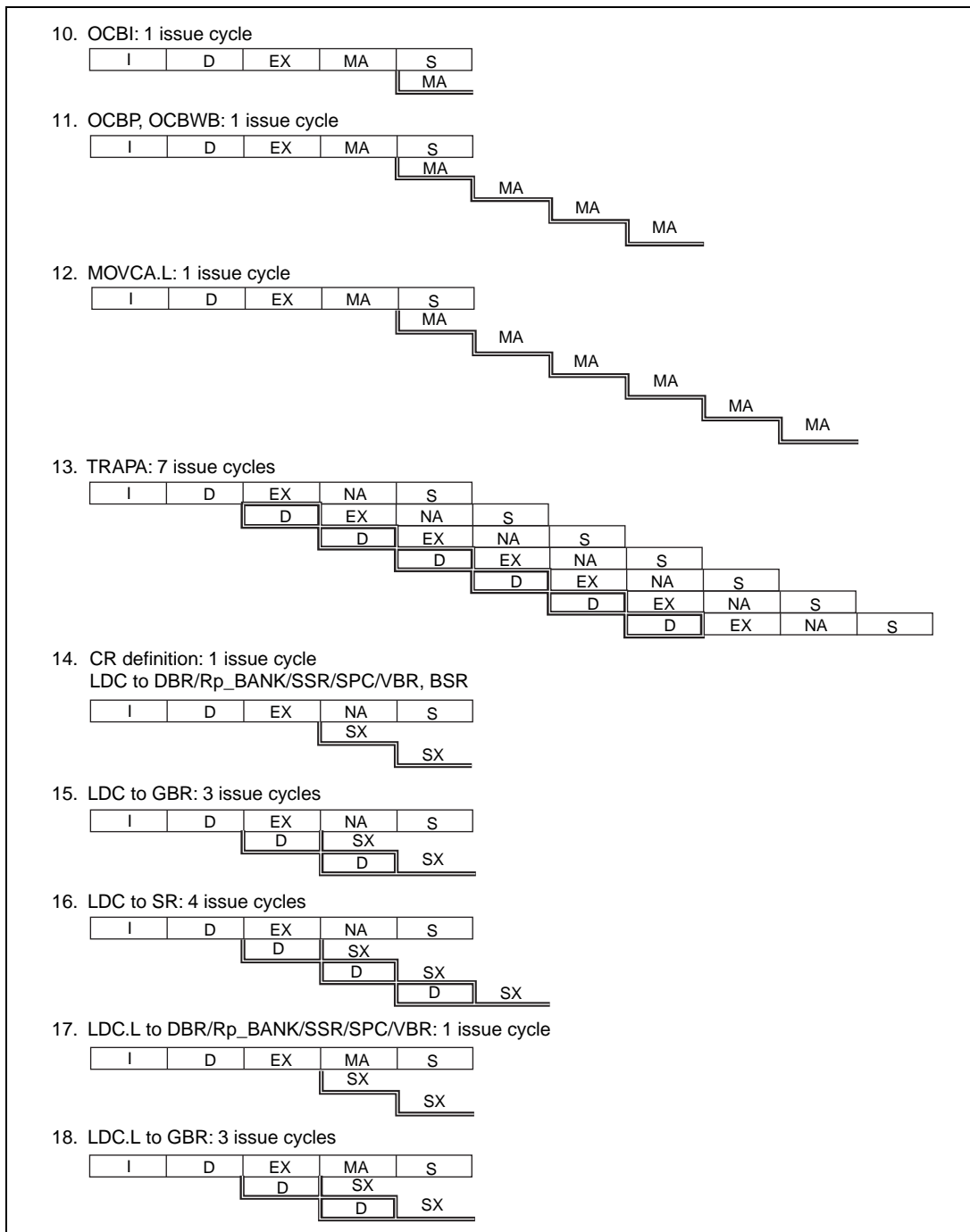
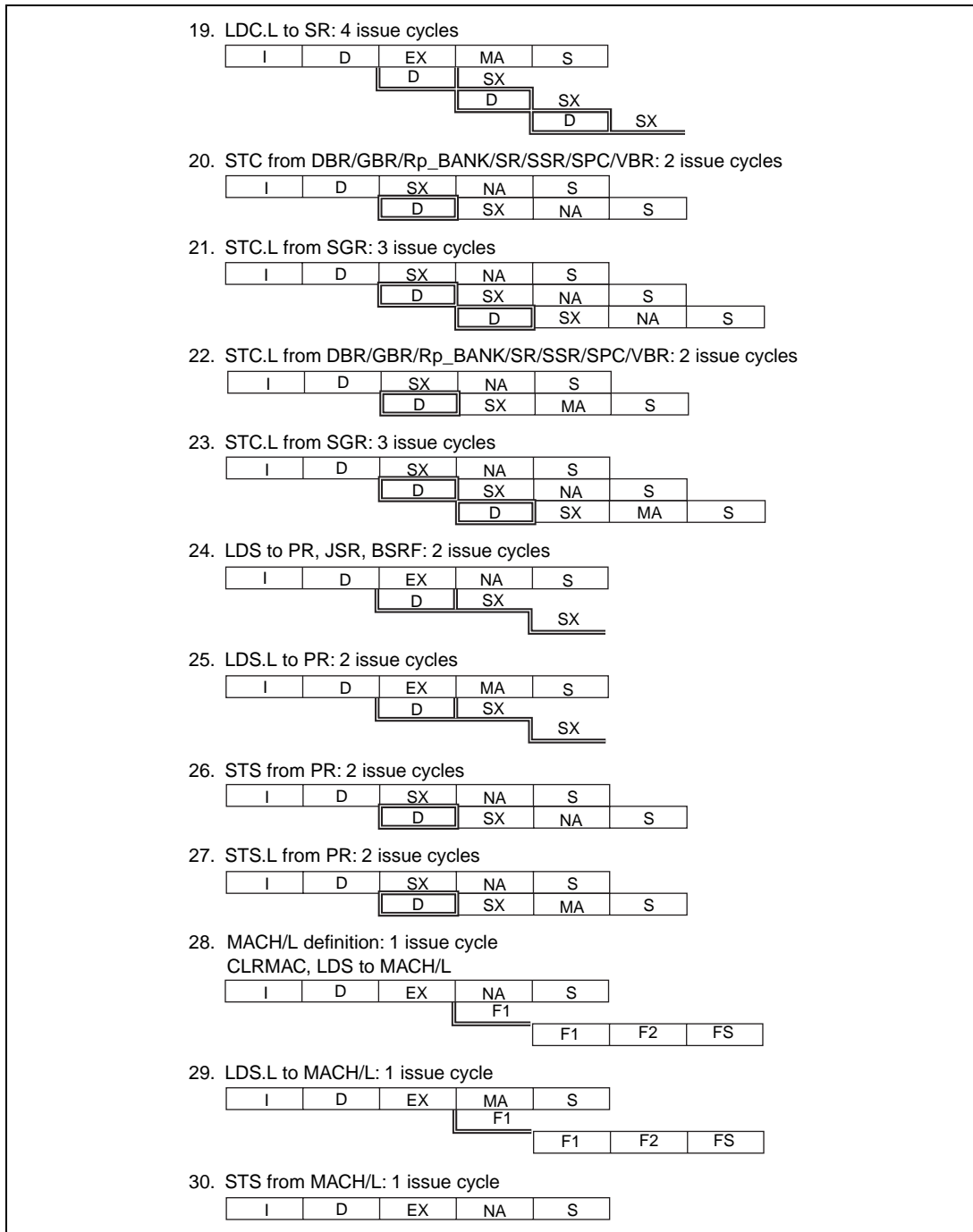

Figure 8.2 Instruction Execution Patterns



**Figure 8.2 Instruction Execution Patterns (cont)**



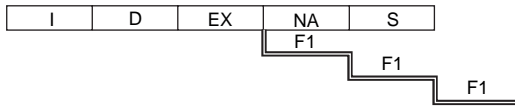

**Figure 8.2 Instruction Execution Patterns (cont)**

31. STS.L from MACH/L: 1 issue cycle



32. LDS to FPSCR: 1 issue cycle



33. LDS.L to FPSCR: 1 issue cycle

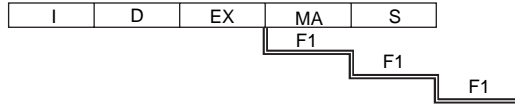

34. Fixed-point multiplication: 2 issue cycles  
DMULS.L, DMULU.L, MUL.L, MULS.W, MULU.W

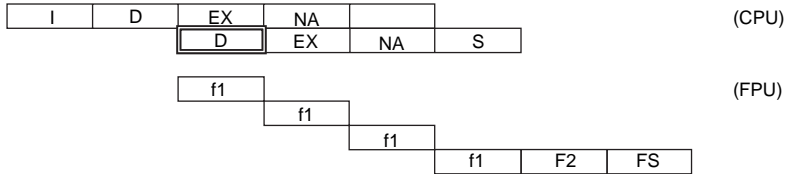

35. MAC.W, MAC.L: 2 issue cycles

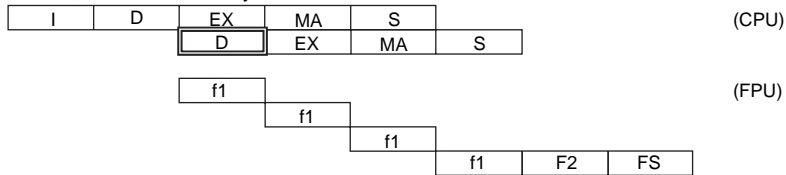

36. Single-precision floating-point computation: 1 issue cycle  
FCMP/EQ,FCMP/GT, FADD,FLOAT,FMAC,FMUL,FSUB,FTRC,FRCHG,FSCHG

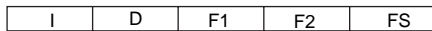

37. Single-precision FDIV/SQRT: 1 issue cycle

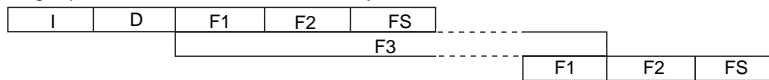

38. Double-precision floating-point computation 1: 1 issue cycle  
FCNVDS, FCNVSD, FLOAT, FTRC

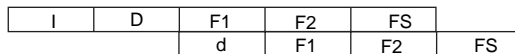

39. Double-precision floating-point computation 2: 1 issue cycle  
FADD, FMUL, FSUB

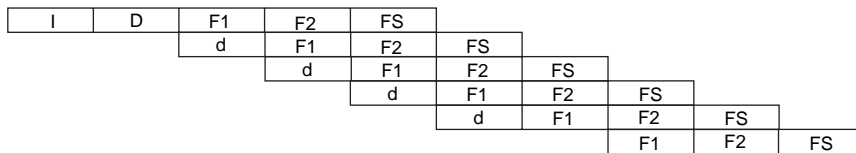
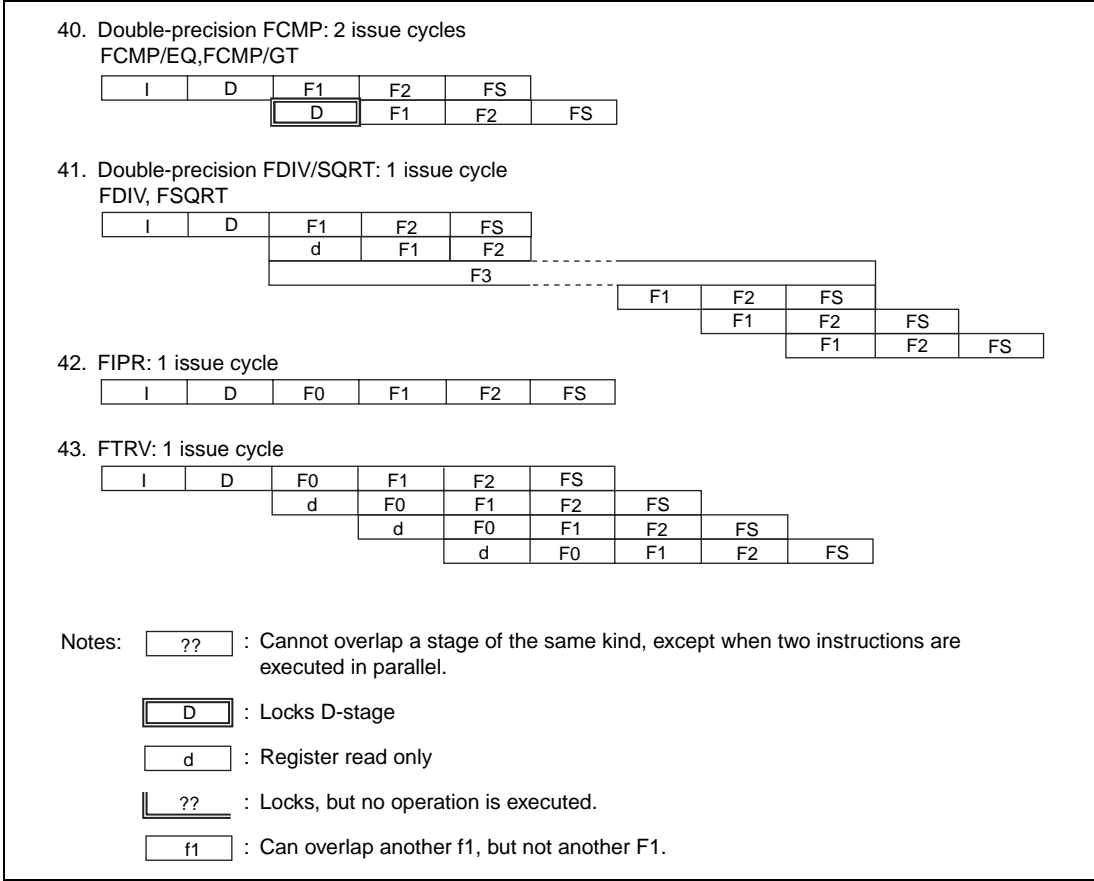

Figure 8.2 Instruction Execution Patterns (cont)



**Figure 8.2 Instruction Execution Patterns (cont)**

## 8.2 Parallel-Executability

Instructions are categorized into six groups according to the internal function blocks used, as shown in table 8.1. Table 8.2 shows the parallel-executability of pairs of instructions in terms of groups. For example, ADD in the EX group and BRA in the BR group can be executed in parallel.

**Table 8.1 Instruction Groups**

### 1. MT Group

CLRT		CMP/HI	Rm,Rn	MOV	Rm,Rn
CMP/EQ	#imm,R0	CMP/HS	Rm,Rn	NOP	
CMP/EQ	Rm,Rn	CMP/PL	Rn	SETT	
CMP/GE	Rm,Rn	CMP/PZ	Rn	TST	#imm,R0
CMP/GT	Rm,Rn	CMP/STR	Rm,Rn	TST	Rm,Rn

### 2. EX Group

ADD	#imm,Rn	MOV <sub>T</sub>	Rn	SHLL2	Rn
ADD	Rm,Rn	NEG	Rm,Rn	SHLL8	Rn
ADDC	Rm,Rn	NEGC	Rm,Rn	SHLR	Rn
ADDV	Rm,Rn	NOT	Rm,Rn	SHLR16	Rn
AND	#imm,R0	OR	#imm,R0	SHLR2	Rn
AND	Rm,Rn	OR	Rm,Rn	SHLR8	Rn
DIV0S	Rm,Rn	ROTCL	Rn	SUB	Rm,Rn
DIV0U		ROTCR	Rn	SUBC	Rm,Rn
DIV1	Rm,Rn	ROTL	Rn	SUBV	Rm,Rn
DT	Rn	ROTR	Rn	SWAP.B	Rm,Rn
EXTS.B	Rm,Rn	SHAD	Rm,Rn	SWAP.W	Rm,Rn
EXTS.W	Rm,Rn	SHAL	Rn	XOR	#imm,R0
EXTU.B	Rm,Rn	SHAR	Rn	XOR	Rm,Rn
EXTU.W	Rm,Rn	SHLD	Rm,Rn	XTRCT	Rm,Rn
MOV	#imm,Rn	SHLL	Rn		
MOVA	@(disp,PC),R0	SHLL16	Rn		

### 3. BR Group

BF	disp	BRA	disp	BT	disp
BF/S	disp	BSR	disp	BT/S	disp

**Table 8.1 Instruction Groups (cont)**

**4. LS Group**

FABS	DRn	FMOV.S	@Rm+,FRn	MOV.L	R0,@(disp,GBR)
FABS	FRn	FMOV.S	FRm,@(R0,Rn)	MOV.L	Rm,@(disp,Rn)
FLDI0	FRn	FMOV.S	FRm,@-Rn	MOV.L	Rm,@(R0,Rn)
FLDI1	FRn	FMOV.S	FRm,@Rn	MOV.L	Rm,@-Rn
FLDS	FRm,FPUL	FNEG	DRn	MOV.L	Rm,@Rn
FMOV	@(R0,Rm),DRn	FNEG	FRn	MOV.W	@(disp,GBR),R0
FMOV	@(R0,Rm),XDn	FSTS	FPUL,FRn	MOV.W	@(disp,PC),Rn
FMOV	@Rm,DRn	LDS	Rm,FPUL	MOV.W	@(disp,Rm),R0
FMOV	@Rm,XDn	MOV.B	@(disp,GBR),R0	MOV.W	@(R0,Rm),Rn
FMOV	@Rm+,DRn	MOV.B	@(disp,Rm),R0	MOV.W	@Rm,Rn
FMOV	@Rm+,XDn	MOV.B	@(R0,Rm),Rn	MOV.W	@Rm+,Rn
FMOV	DRm,@(R0,Rn)	MOV.B	@Rm,Rn	MOV.W	R0,@(disp,GBR)
FMOV	DRm,@-Rn	MOV.B	@Rm+,Rn	MOV.W	R0,@(disp,Rn)
FMOV	DRm,@Rn	MOV.B	R0,@(disp,GBR)	MOV.W	Rm,@(R0,Rn)
FMOV	DRm,DRn	MOV.B	R0,@(disp,Rn)	MOV.W	Rm,@-Rn
FMOV	DRm,XDn	MOV.B	Rm,@(R0,Rn)	MOV.W	Rm,@Rn
FMOV	FRm,FRn	MOV.B	Rm,@-Rn	MOVCA.L	R0,@Rn
FMOV	XDm,@(R0,Rn)	MOV.B	Rm,@Rn	OCBI	@Rn
FMOV	XDm,@-Rn	MOV.L	@(disp,GBR),R0	OCBP	@Rn
FMOV	XDm,@Rn	MOV.L	@(disp,PC),Rn	OCBWB	@Rn
FMOV	XDm,DRn	MOV.L	@(disp,Rm),Rn	PREF	@Rn
FMOV	XDm,XDn	MOV.L	@(R0,Rm),Rn	STS	FPUL,Rn
FMOV.S	@(R0,Rm),FRn	MOV.L	@Rm,Rn		
FMOV.S	@Rm,FRn	MOV.L	@Rm+,Rn		

**Table 8.1 Instruction Groups (cont)**

**5. FE Group**

FADD	DRm,DRn	FIPR	FVm,FVn	FSQRT	DRn
FADD	FRm,FRn	FLOAT	FPUL,DRn	FSQRT	FRn
FCMP/EQ	FRm,FRn	FLOAT	FPUL,FRn	FSUB	DRm,DRn
FCMP/GT	FRm,FRn	FMAC	FR0,FRm,FRn	FSUB	FRm,FRn
FCNVDS	DRm,FPUL	FMUL	DRm,DRn	FTRC	DRm,FPUL
FCNVSD	FPUL,DRn	FMUL	FRm,FRn	FTRC	FRm,FPUL
FDIV	DRm,DRn	FRCHG		FTRV	XMTRX,FVn
FDIV	FRm,FRn	FSCHG			

**Table 8.1 Instruction Groups (cont)**

**6. CO Group**

AND.B	#imm,@(R0,GBR)	LDS	Rm,FPSCR	STC	SR,Rn
BRAF	Rm	LDS	Rm,MACH	STC	SSR,Rn
BSRF	Rm	LDS	Rm,MACL	STC	VBR,Rn
CLRMAC		LDS	Rm,PR	STC.L	DBR,@-Rn
CLRS		LDS.L	@Rm+,FPSCR	STC.L	GBR,@-Rn
DMULS.L	Rm,Rn	LDS.L	@Rm+,FPUL	STC.L	Rp_BANK,@-Rn
DMULU.L	Rm,Rn	LDS.L	@Rm+,MACH	STC.L	SGR,@-Rn
FCMP/EQ	DRm,DRn	LDS.L	@Rm+,MACL	STC.L	SPC,@-Rn
FCMP/GT	DRm,DRn	LDS.L	@Rm+,PR	STC.L	SR,@-Rn
JMP	@Rn	LDTLB		STC.L	SSR,@-Rn
JSR	@Rn	MAC.L	@Rm+,@Rn+	STC.L	VBR,@-Rn
LDC	Rm,DBR	MAC.W	@Rm+,@Rn+	STS	FPSCR,Rn
LDC	Rm,GBR	MUL.L	Rm,Rn	STS	MACH,Rn
LDC	Rm,Rp_BANK	MULS.W	Rm,Rn	STS	MACL,Rn
LDC	Rm,SPC	MULU.W	Rm,Rn	STS	PR,Rn
LDC	Rm,SR	OR.B	#imm,@(R0,GBR)	STS.L	FPSCR,@-Rn
LDC	Rm,SSR	RTE		STS.L	FPUL,@-Rn
LDC	Rm,VBR	RTS		STS.L	MACH,@-Rn
LDC.L	@Rm+,DBR	SETS		STS.L	MACL,@-Rn
LDC.L	@Rm+,GBR	SLEEP		STS.L	PR,@-Rn
LDC.L	@Rm+,Rp_BANK	STC	DBR,Rn	TAS.B	@Rn
LDC.L	@Rm+,SPC	STC	GBR,Rn	TRAPA	#imm
LDC.L	@Rm+,SR	STC	Rp_BANK,Rn	TST.B	#imm,@(R0,GBR)
LDC.L	@Rm+,SSR	STC	SGR,Rn	XOR.B	#imm,@(R0,GBR)
LDC.L	@Rm+,VBR	STC	SPC,Rn		

**Table 8.2 Parallel-Executability**

		2nd Instruction					
		MT	EX	BR	LS	FE	CO
1st Instruction	MT	O	O	O	O	O	X
	EX	O	X	O	O	O	X
	BR	O	O	X	O	O	X
	LS	O	O	O	X	O	X
	FE	O	O	O	O	X	X
	CO	X	X	X	X	X	X

O: Can be executed in parallel

X: Cannot be executed in parallel

### 8.3 Execution Cycles and Pipeline Stalling

There are three basic clocks in this processor: the I-clock, B-clock, and P-clock. Each hardware unit operates on one of these clocks, as follows:

- I-clock: CPU, FPU, MMU, caches
- B-clock: External bus controller
- P-clock: Peripheral units

The frequency ratios of the three clocks are determined with the frequency control register (FRQCR). In this section, machine cycles are based on the I-clock unless otherwise specified. For details of FRQCR, see section 10, Clock Oscillation Circuits.

Instruction execution cycles are summarized in table 8.3. Penalty cycles due to a pipeline stall or freeze are not considered in this table.

- Issue rate: Interval between the issue of an instruction and that of the next instruction
- Latency: Interval between the issue of an instruction and the generation of its result (completion)
- Instruction execution pattern (see figure 8.2)
- Locked pipeline stages
- Interval between the issue of an instruction and the start of locking
- Lock time: Period of locking in machine cycle units



The instruction execution sequence is expressed as a combination of the execution patterns shown in figure 8.2. One instruction is separated from the next by the number of machine cycles for its issue rate. Normally, execution, data access, and write-back stages cannot be overlapped onto the same stages of another instruction; the only exception is when two instructions are executed in parallel under parallel-executability conditions. Refer to (a) through (d) in figure 8.3 for some simple examples.

Latency is the interval between issue and completion of an instruction, and is also the interval between the execution of two instructions with an interdependent relationship. When there is interdependency between two instructions fetched simultaneously, the latter of the two is stalled for the following number of cycles:

- (Latency) cycles when there is flow dependency (read-after-write)
- (Latency - 1) or (latency - 2) cycles when there is output dependency (write-after-write)
  - Single/double-precision FDIV, FSQRT is the preceding instruction (latency - 1) cycles
  - The other FE group is the preceding instruction (latency - 2) cycles
- 5 or 2 cycles when there is anti-flow dependency (write-after-read), as in the following cases:
  - FTRV is the preceding instruction (5 cycle)
  - A double-precision FADD, FSUB, or FMUL is the preceding instruction (2 cycles)

In the case of flow dependency, latency may be exceptionally increased or decreased, depending on the combination of sequential instructions (figure 8.3 (e)).

- When a floating-point (FP) computation is followed by an FP register store, the latency of the FP computation may be decreased by 1 cycle.
- If there is a load of the shift amount immediately before an SHAD/SHLD instruction, the latency of the load is increased by 1 cycle.
- If an instruction with a latency of less than 2 cycles, including write-back to an FP register, is followed by a double-precision FP instruction, FIPR, or FTRV, the latency of the first instruction is increased to 2 cycles.

The number of cycles in a pipeline stall due to flow dependency will vary depending on the combination of interdependent instructions or the fetch timing (see figure 8.3. (e)).

Output dependency occurs when the destination operands are the same in a preceding FE group instruction and a following LS group instruction.

For the stall cycles of an instruction with output dependency, the longest latency to the last write-back among all the destination operands must be applied instead of “latency” (see figure 8.3 (f)). A stall due to output dependency with respect to FPSCR, which reflects the result of an FP operation, never occurs. For example, when FADD follows FDIV with no dependency between FP registers, FADD is not stalled even if both instructions update the cause field of FPSCR.

Anti-flow dependency can occur only between a preceding double-precision FADD, FMUL, FSUB, or FTRV and a following FMOV, FLDI0, FLDI1, FABS, FNEG, or FSTS. See figure 8.3 (g).

If an executing instruction locks any resource—i.e. a function block that performs a basic operation—a following instruction that happens to attempt to use the locked resource must be stalled (figure 8.3 (h)). This kind of stall can be compensated by inserting one or more instructions independent of the locked resource to separate the interfering instructions. For example, when a load instruction and an ADD instruction that references the loaded value are consecutive, the 2-cycle stall of the ADD is eliminated by inserting three instructions without dependency. Software performance can be improved by such instruction scheduling.

Other penalties arise in the event of exceptions or external data accesses, as follows.

- Instruction TLB miss: a penalty of 7 CPU clocks
- Instruction access to external memory (instruction cache miss, etc.)
- Data access to external memory (operand cache miss, etc.): a penalty of 2 CPU clocks + 3 bus clocks
- Data access to a memory-mapped control register. The penalty differs from register to register, and depends on the kind of operation (read or write), the clock mode, and the bus use conditions when the access is made.

During the penalty cycles of an instruction TLB miss or external instruction access, no instruction is issued, but execution of instructions that have already been issued continues. The penalty for a data access is a pipeline freeze: that is, the execution of uncompleted instructions is interrupted until the arrival of the requested data. The number of penalty cycles for instruction and data accesses is largely dependent on the user's memory subsystems.

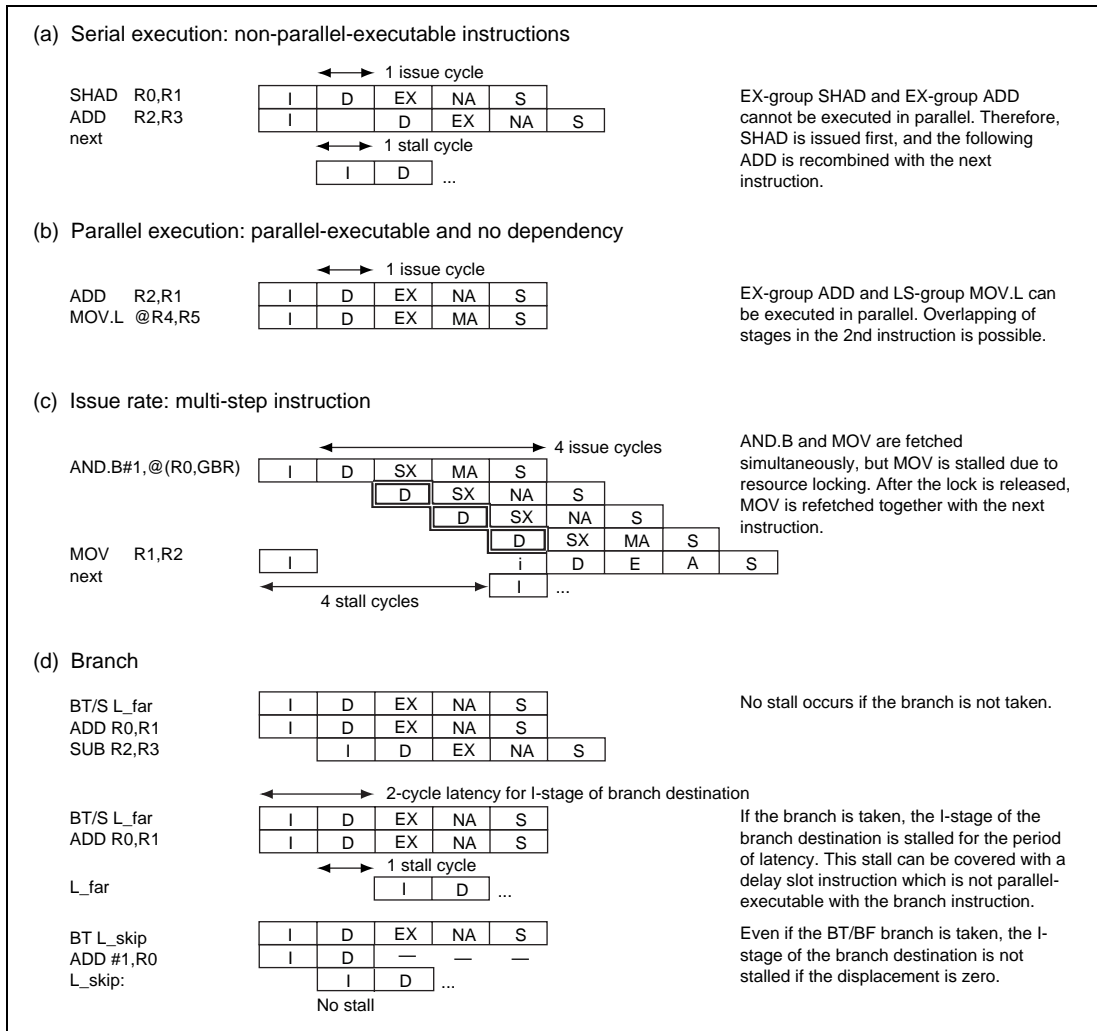

**Figure 8.3 Examples of Pipelined Execution**

(e) Flow dependency

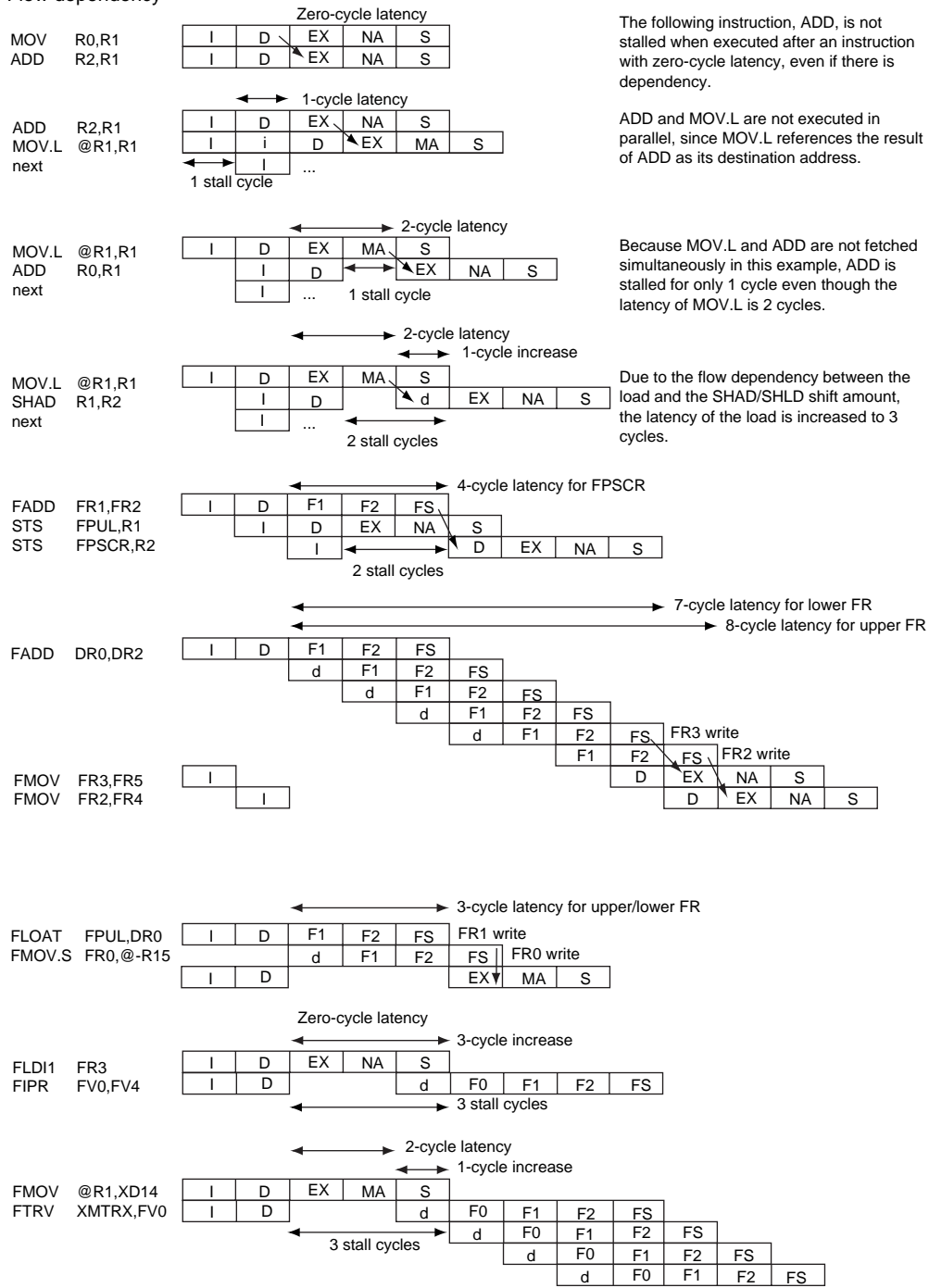

The following instruction, ADD, is not stalled when executed after an instruction with zero-cycle latency, even if there is dependency.

ADD and MOV.L are not executed in parallel, since MOV.L references the result of ADD as its destination address.

Because MOV.L and ADD are not fetched simultaneously in this example, ADD is stalled for only 1 cycle even though the latency of MOV.L is 2 cycles.

Due to the flow dependency between the load and the SHAD/SHLD shift amount, the latency of the load is increased to 3 cycles.

Figure 8.3 Examples of Pipelined Execution (cont)

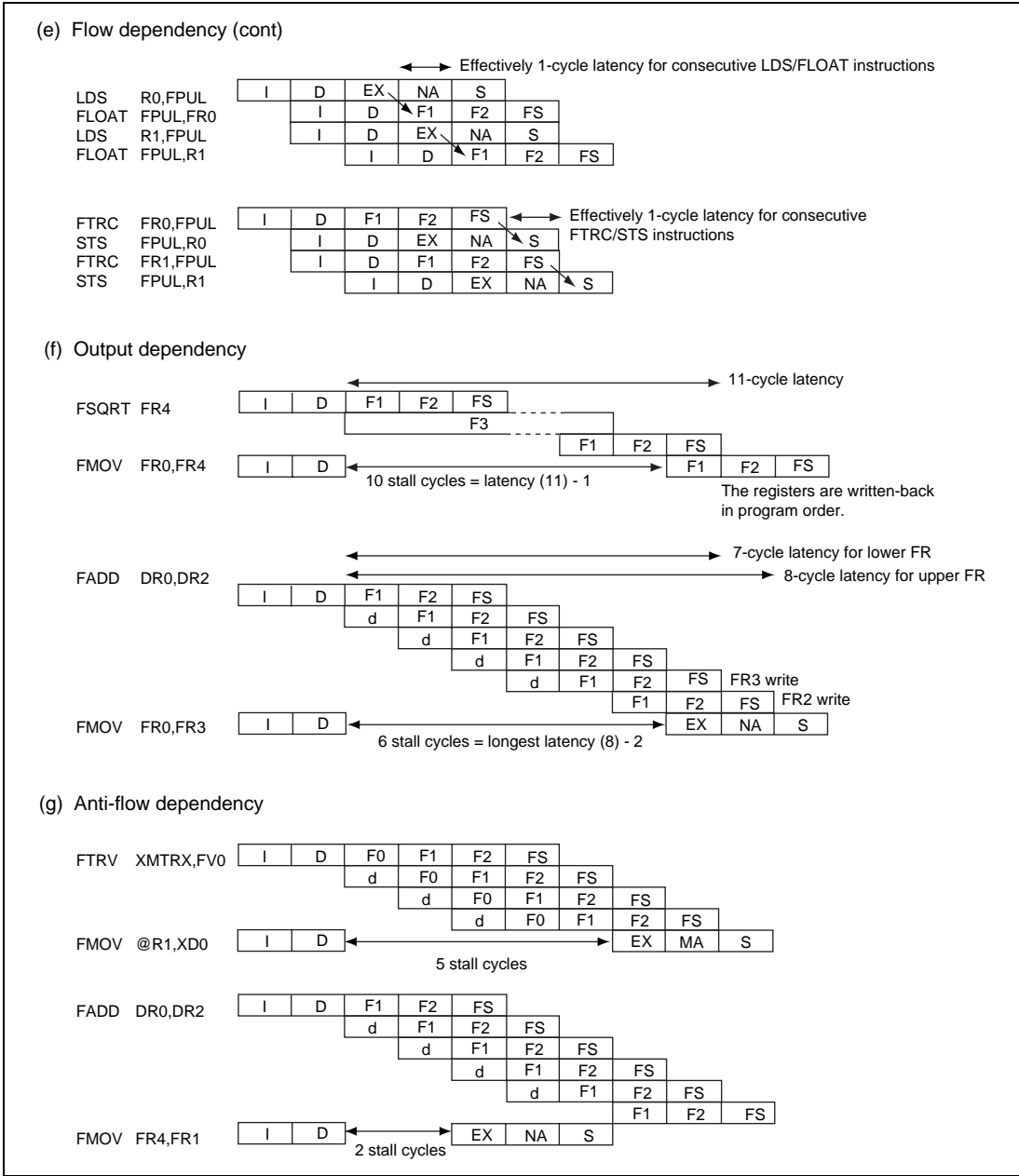

Figure 8.3 Examples of Pipelined Execution (cont)

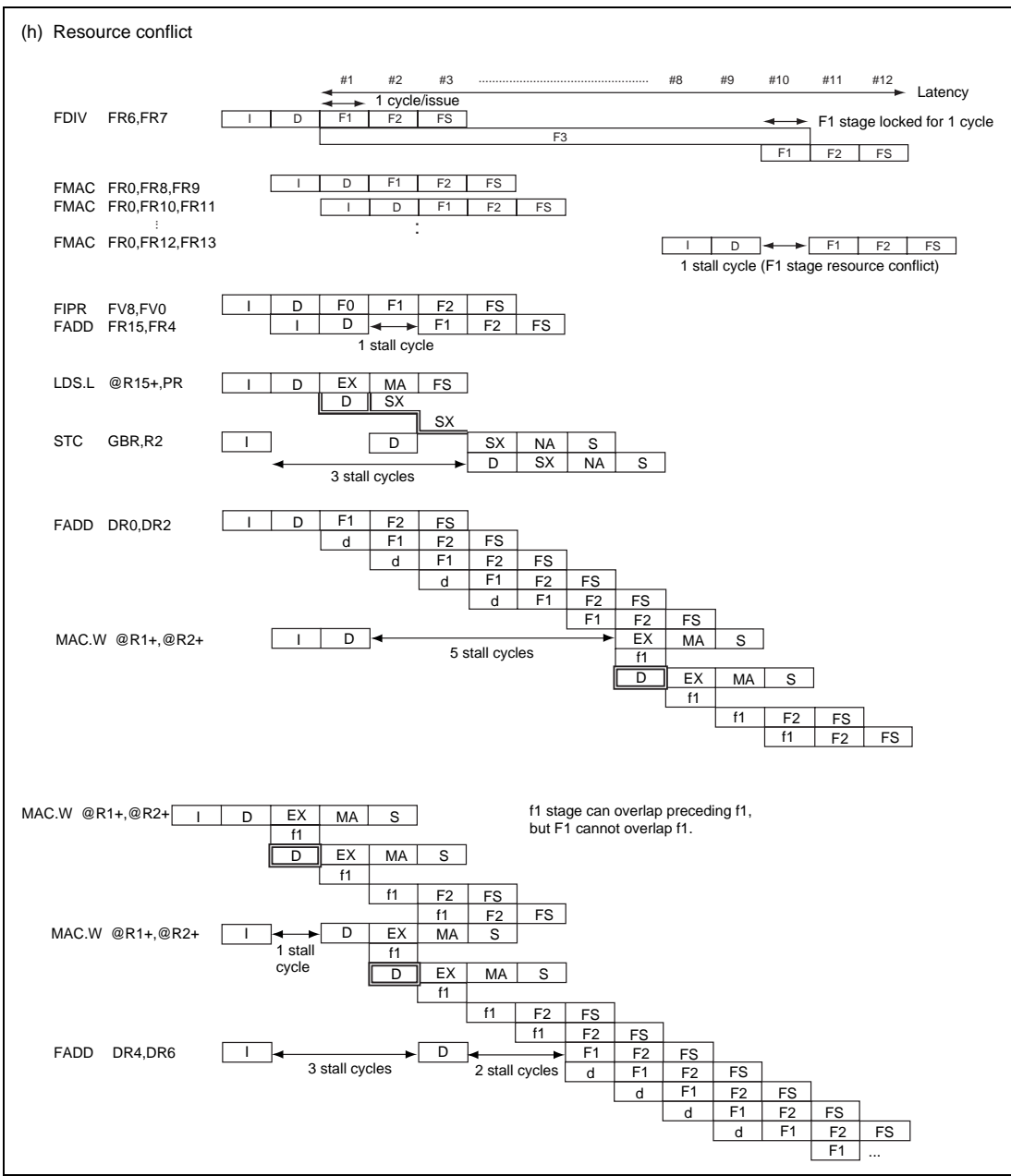

Figure 8.3 Examples of Pipelined Execution (cont)

**Table 8.3 Execution Cycles**

Functional Category	No.	Instruction	Instruction Group	Issue Rate	Latency	Execution Pattern	Lock		
							Stage	Start	Cycles
Data transfer instructions	1	EXTS.B Rm,Rn	EX	1	1	#1	—	—	—
	2	EXTS.W Rm,Rn	EX	1	1	#1	—	—	—
	3	EXTU.B Rm,Rn	EX	1	1	#1	—	—	—
	4	EXTU.W Rm,Rn	EX	1	1	#1	—	—	—
	5	MOV Rm,Rn	MT	1	0	#1	—	—	—
	6	MOV #imm,Rn	EX	1	1	#1	—	—	—
	7	MOVA @(disp,PC),R0	EX	1	1	#1	—	—	—
	8	MOV.W @(disp,PC),Rn	LS	1	2	#2	—	—	—
	9	MOV.L @(disp,PC),Rn	LS	1	2	#2	—	—	—
	10	MOV.B @Rm,Rn	LS	1	2	#2	—	—	—
	11	MOV.W @Rm,Rn	LS	1	2	#2	—	—	—
	12	MOV.L @Rm,Rn	LS	1	2	#2	—	—	—
	13	MOV.B @Rm+,Rn	LS	1	1/2	#2	—	—	—
	14	MOV.W @Rm+,Rn	LS	1	1/2	#2	—	—	—
	15	MOV.L @Rm+,Rn	LS	1	1/2	#2	—	—	—
	16	MOV.B @(disp,Rm),R0	LS	1	2	#2	—	—	—
	17	MOV.W @(disp,Rm),R0	LS	1	2	#2	—	—	—
	18	MOV.L @(disp,Rm),Rn	LS	1	2	#2	—	—	—
	19	MOV.B @(R0,Rm),Rn	LS	1	2	#2	—	—	—
	20	MOV.W @(R0,Rm),Rn	LS	1	2	#2	—	—	—
	21	MOV.L @(R0,Rm),Rn	LS	1	2	#2	—	—	—
	22	MOV.B @(disp,GBR),R0	LS	1	2	#3	—	—	—
	23	MOV.W @(disp,GBR),R0	LS	1	2	#3	—	—	—
	24	MOV.L @(disp,GBR),R0	LS	1	2	#3	—	—	—
	25	MOV.B Rm,@Rn	LS	1	1	#2	—	—	—
	26	MOV.W Rm,@Rn	LS	1	1	#2	—	—	—
	27	MOV.L Rm,@Rn	LS	1	1	#2	—	—	—
	28	MOV.B Rm,@-Rn	LS	1	1/1	#2	—	—	—
	29	MOV.W Rm,@-Rn	LS	1	1/1	#2	—	—	—
	30	MOV.L Rm,@-Rn	LS	1	1/1	#2	—	—	—
	31	MOV.B R0,@(disp,Rn)	LS	1	1	#2	—	—	—

**Table 8.3 Execution Cycles (cont)**

Functional Category	No.	Instruction	Instruc- tion Group	Issue Rate	Latency	Execu- tion Pattern	Lock			
							Stage	Start	Cycles	
Data transfer instructions	32	MOV.W	R0,@(disp,Rn)	LS	1	1	#2	—	—	—
	33	MOV.L	Rm,@(disp,Rn)	LS	1	1	#2	—	—	—
	34	MOV.B	Rm,@(R0,Rn)	LS	1	1	#2	—	—	—
	35	MOV.W	Rm,@(R0,Rn)	LS	1	1	#2	—	—	—
	36	MOV.L	Rm,@(R0,Rn)	LS	1	1	#2	—	—	—
	37	MOV.B	R0,@(disp,GBR)	LS	1	1	#3	—	—	—
	38	MOV.W	R0,@(disp,GBR)	LS	1	1	#3	—	—	—
	39	MOV.L	R0,@(disp,GBR)	LS	1	1	#3	—	—	—
	40	MOVCA.L	R0,@Rn	LS	1	3–7	#12	MA	4	3–7
	41	MOV.T	Rn	EX	1	1	#1	—	—	—
	42	OCBI	@Rn	LS	1	1–2	#10	MA	4	1–2
	43	OCBP	@Rn	LS	1	1–5	#11	MA	4	1–5
	44	OCBWB	@Rn	LS	1	1–5	#11	MA	4	1–5
	45	PREF	@Rn	LS	1	1	#2	—	—	—
	46	SWAP.B	Rm,Rn	EX	1	1	#1	—	—	—
	47	SWAP.W	Rm,Rn	EX	1	1	#1	—	—	—
	48	XTRCT	Rm,Rn	EX	1	1	#1	—	—	—
	Fixed-point arithmetic instructions	49	ADD	Rm,Rn	EX	1	1	#1	—	—
50		ADD	#imm,Rn	EX	1	1	#1	—	—	—
51		ADDC	Rm,Rn	EX	1	1	#1	—	—	—
52		ADDV	Rm,Rn	EX	1	1	#1	—	—	—
53		CMP/EQ	#imm,R0	MT	1	1	#1	—	—	—
54		CMP/EQ	Rm,Rn	MT	1	1	#1	—	—	—
55		CMP/GE	Rm,Rn	MT	1	1	#1	—	—	—
56		CMP/GT	Rm,Rn	MT	1	1	#1	—	—	—
57		CMP/HI	Rm,Rn	MT	1	1	#1	—	—	—
58		CMP/HS	Rm,Rn	MT	1	1	#1	—	—	—
59		CMP/PL	Rn	MT	1	1	#1	—	—	—
60		CMP/PZ	Rn	MT	1	1	#1	—	—	—
61		CMP/STR	Rm,Rn	MT	1	1	#1	—	—	—
62		DIV0S	Rm,Rn	EX	1	1	#1	—	—	—



**Table 8.3 Execution Cycles (cont)**

Functional Category	No.	Instruction	Instruc-tion Group	Issue Rate	Latency	Execu-tion Pattern	Lock		
							Stage	Start	Cycles
Fixed-point arithmetic instructions	63	DIV0U	EX	1	1	#1	—	—	—
	64	DIV1 Rm,Rn	EX	1	1	#1	—	—	—
	65	DMULS.L Rm,Rn	CO	2	4/4	#34	F1	4	2
	66	DMULU.L Rm,Rn	CO	2	4/4	#34	F1	4	2
	67	DT Rn	EX	1	1	#1	—	—	—
	68	MAC.L @Rm+, @Rn+	CO	2	2/2/4/4	#35	F1	4	2
	69	MAC.W @Rm+, @Rn+	CO	2	2/2/4/4	#35	F1	4	2
	70	MUL.L Rm,Rn	CO	2	4/4	#34	F1	4	2
	71	MULS.W Rm,Rn	CO	2	4/4	#34	F1	4	2
	72	MULU.W Rm,Rn	CO	2	4/4	#34	F1	4	2
	73	NEG Rm,Rn	EX	1	1	#1	—	—	—
	74	NEGC Rm,Rn	EX	1	1	#1	—	—	—
	75	SUB Rm,Rn	EX	1	1	#1	—	—	—
	76	SUBC Rm,Rn	EX	1	1	#1	—	—	—
	77	SUBV Rm,Rn	EX	1	1	#1	—	—	—
Logical instructions	78	AND Rm,Rn	EX	1	1	#1	—	—	—
	79	AND #imm,R0	EX	1	1	#1	—	—	—
	80	AND.B #imm,@(R0,GBR)	CO	4	4	#6	—	—	—
	81	NOT Rm,Rn	EX	1	1	#1	—	—	—
	82	OR Rm,Rn	EX	1	1	#1	—	—	—
	83	OR #imm,R0	EX	1	1	#1	—	—	—
	84	OR.B #imm,@(R0,GBR)	CO	4	4	#6	—	—	—
	85	TAS.B @Rn	CO	5	5	#7	—	—	—
	86	TST Rm,Rn	MT	1	1	#1	—	—	—
	87	TST #imm,R0	MT	1	1	#1	—	—	—
	88	TST.B #imm,@(R0,GBR)	CO	3	3	#5	—	—	—
	89	XOR Rm,Rn	EX	1	1	#1	—	—	—
	90	XOR #imm,R0	EX	1	1	#1	—	—	—
	91	XOR.B #imm,@(R0,GBR)	CO	4	4	#6	—	—	—

**Table 8.3 Execution Cycles (cont)**

Functional Category	No.	Instruction	Instruction Group	Issue Rate	Latency	Execution Pattern	Lock		
							Stage	Start	Cycles
Shift instructions	92	ROTL Rn	EX	1	1	#1	—	—	—
	93	ROTR Rn	EX	1	1	#1	—	—	—
	94	ROTCL Rn	EX	1	1	#1	—	—	—
	95	ROTCR Rn	EX	1	1	#1	—	—	—
	96	SHAD Rm,Rn	EX	1	1	#1	—	—	—
	97	SHAL Rn	EX	1	1	#1	—	—	—
	98	SHAR Rn	EX	1	1	#1	—	—	—
	99	SHLD Rm,Rn	EX	1	1	#1	—	—	—
	100	SHLL Rn	EX	1	1	#1	—	—	—
	101	SHLL2 Rn	EX	1	1	#1	—	—	—
	102	SHLL8 Rn	EX	1	1	#1	—	—	—
	103	SHLL16 Rn	EX	1	1	#1	—	—	—
	104	SHLR Rn	EX	1	1	#1	—	—	—
	105	SHLR2 Rn	EX	1	1	#1	—	—	—
	106	SHLR8 Rn	EX	1	1	#1	—	—	—
	107	SHLR16 Rn	EX	1	1	#1	—	—	—
	Branch instructions	108	BF disp	BR	1	2 (or 1)	#1	—	—
109		BF/S disp	BR	1	2 (or 1)	#1	—	—	—
110		BT disp	BR	1	2 (or 1)	#1	—	—	—
111		BT/S disp	BR	1	2 (or 1)	#1	—	—	—
112		BRA disp	BR	1	2	#1	—	—	—
113		BRAF Rn	CO	2	3	#4	—	—	—
114		BSR disp	BR	1	2	#14	SX	3	2
115		BSRF Rn	CO	2	3	#24	SX	3	2
116		JMP @Rn	CO	2	3	#4	—	—	—
117		JSR @Rn	CO	2	3	#24	SX	3	2
118		RTS	CO	2	3	#4	—	—	—

**Table 8.3 Execution Cycles (cont)**

Functional Category	No.	Instruction	Instruc- tion Group	Issue Rate	Latency	Execu- tion Pattern	Lock		
							Stage	Start	Cycles
System control instructions	119	NOP	MT	1	0	#1	—	—	—
	120	CLRMAC	CO	1	3	#28	F1	3	2
	121	CLRS	CO	1	1	#1	—	—	—
	122	CLRT	MT	1	1	#1	—	—	—
	123	SETS	CO	1	1	#1	—	—	—
	124	SETT	MT	1	1	#1	—	—	—
	125	TRAPA #imm	CO	7	7	#13	—	—	—
	126	RTE	CO	5	5	#8	—	—	—
	127	SLEEP	CO	4	4	#9	—	—	—
	128	LDTLB	CO	1	1	#2	—	—	—
	129	LDC Rm,DBR	CO	1	3	#14	SX	3	2
	130	LDC Rm,GBR	CO	3	3	#15	SX	3	2
	131	LDC Rm,Rp_BANK	CO	1	3	#14	SX	3	2
	132	LDC Rm,SR	CO	4	4	#16	SX	3	2
	133	LDC Rm,SSR	CO	1	3	#14	SX	3	2
	134	LDC Rm,SPC	CO	1	3	#14	SX	3	2
	135	LDC Rm,VBR	CO	1	3	#14	SX	3	2
	136	LDC.L @Rm+,DBR	CO	1	1/3	#17	SX	3	2
	137	LDC.L @Rm+,GBR	CO	3	3/3	#18	SX	3	2
	138	LDC.L @Rm+,Rp_BANK	CO	1	1/3	#17	SX	3	2
	139	LDC.L @Rm+,SR	CO	4	4/4	#19	SX	3	2
	140	LDC.L @Rm+,SSR	CO	1	1/3	#17	SX	3	2
	141	LDC.L @Rm+,SPC	CO	1	1/3	#17	SX	3	2
	142	LDC.L @Rm+,VBR	CO	1	1/3	#17	SX	3	2
	143	LDS Rm,MACH	CO	1	3	#28	F1	3	2
	144	LDS Rm,MACL	CO	1	3	#28	F1	3	2
	145	LDS Rm,PR	CO	2	3	#24	SX	3	2
	146	LDS.L @Rm+,MACH	CO	1	1/3	#29	F1	3	2
	147	LDS.L @Rm+,MACL	CO	1	1/3	#29	F1	3	2
	148	LDS.L @Rm+,PR	CO	2	2/3	#25	SX	3	2
149	STC DBR,Rn	CO	2	2	#20	—	—	—	
150	STC SGR,Rn	CO	3	3	#21	—	—	—	

**Table 8.3 Execution Cycles (cont)**

Functional Category	No.	Instruction	Instruc- tion Group	Issue Rate	Latency	Execu- tion Pattern	Lock			
							Stage	Start	Cycles	
System control instructions	151	STC	GBR,Rn	CO	2	2	#20	—	—	—
	152	STC	Rp_BANK,Rn	CO	2	2	#20	—	—	—
	153	STC	SR,Rn	CO	2	2	#20	—	—	—
	154	STC	SSR,Rn	CO	2	2	#20	—	—	—
	155	STC	SPC,Rn	CO	2	2	#20	—	—	—
	156	STC	VBR,Rn	CO	2	2	#20	—	—	—
	157	STC.L	DBR,@-Rn	CO	2	2/2	#22	—	—	—
	158	STC.L	SGR,@-Rn	CO	3	3/3	#23	—	—	—
	159	STC.L	GBR,@-Rn	CO	2	2/2	#22	—	—	—
	160	STC.L	Rp_BANK,@-Rn	CO	2	2/2	#22	—	—	—
	161	STC.L	SR,@-Rn	CO	2	2/2	#22	—	—	—
	162	STC.L	SSR,@-Rn	CO	2	2/2	#22	—	—	—
	163	STC.L	SPC,@-Rn	CO	2	2/2	#22	—	—	—
	164	STC.L	VBR,@-Rn	CO	2	2/2	#22	—	—	—
	165	STS	MACH,Rn	CO	1	3	#30	—	—	—
	166	STS	MACL,Rn	CO	1	3	#30	—	—	—
	167	STS	PR,Rn	CO	2	2	#26	—	—	—
	168	STS.L	MACH,@-Rn	CO	1	1/1	#31	—	—	—
	169	STS.L	MACL,@-Rn	CO	1	1/1	#31	—	—	—
	170	STS.L	PR,@-Rn	CO	2	2/2	#27	—	—	—
Single- precision floating-point instructions	171	FLDI0	FRn	LS	1	0	#1	—	—	—
	172	FLDI1	FRn	LS	1	0	#1	—	—	—
	173	FMOV	FRm,FRn	LS	1	0	#1	—	—	—
	174	FMOV.S	@Rm,FRn	LS	1	2	#2	—	—	—
	175	FMOV.S	@Rm+,FRn	LS	1	1/2	#2	—	—	—
	176	FMOV.S	@(R0,Rm),FRn	LS	1	2	#2	—	—	—
	177	FMOV.S	FRm,@Rn	LS	1	1	#2	—	—	—
	178	FMOV.S	FRm,@-Rn	LS	1	1/1	#2	—	—	—
	179	FMOV.S	FRm,@(R0,Rn)	LS	1	1	#2	—	—	—
	180	FLDS	FRm,FPUL	LS	1	0	#1	—	—	—
	181	FSTS	FPUL,FRn	LS	1	0	#1	—	—	—

**Table 8.3 Execution Cycles (cont)**

Functional Category	No.	Instruction	Instruc-tion Group	Issue Rate	Latency	Execu-tion Pattern	Lock			
							Stage	Start	Cycles	
Single-precision floating-point instructions	182	FABS	FRn	LS	1	0	#1	—	—	—
	183	FADD	FRm,FRn	FE	1	3/4	#36	—	—	—
	184	FCMP/EQ	FRm,FRn	FE	1	2/4	#36	—	—	—
	185	FCMP/GT	FRm,FRn	FE	1	2/4	#36	—	—	—
	186	FDIV	FRm,FRn	FE	1	12/13	#37	F3	2	10
								F1	11	1
	187	FLOAT	FPUL,FRn	FE	1	3/4	#36	—	—	—
	188	FMAC	FR0,FRm,FRn	FE	1	3/4	#36	—	—	—
	189	FMUL	FRm,FRn	FE	1	3/4	#36	—	—	—
	190	FNEG	FRn	LS	1	0	#1	—	—	—
	191	FSQRT	FRn	FE	1	11/12	#37	F3	2	9
								F1	10	1
	192	FSUB	FRm,FRn	FE	1	3/4	#36	—	—	—
	193	FTRC	FRm,FPUL	FE	1	3/4	#36	—	—	—
	194	FMOV	DRm,DRn	LS	1	0	#1	—	—	—
	195	FMOV	@Rm,DRn	LS	1	2	#2	—	—	—
	196	FMOV	@Rm+,DRn	LS	1	1/2	#2	—	—	—
	197	FMOV	@(R0,Rm),DRn	LS	1	2	#2	—	—	—
	198	FMOV	DRm,@Rn	LS	1	1	#2	—	—	—
	199	FMOV	DRm,@-Rn	LS	1	1/1	#2	—	—	—
200	FMOV	DRm,@(R0,Rn)	LS	1	1	#2	—	—	—	
Double-precision floating-point instructions	201	FABS	DRn	LS	1	0	#1	—	—	—
	202	FADD	DRm,DRn	FE	1	(7, 8)/9	#39	F1	2	6
	203	FCMP/EQ	DRm,DRn	CO	2	3/5	#40	F1	2	2
	204	FCMP/GT	DRm,DRn	CO	2	3/5	#40	F1	2	2
	205	FCNVDS	DRm,FPUL	FE	1	4/5	#38	F1	2	2
	206	FCNVSD	FPUL,DRn	FE	1	(3, 4)/5	#38	F1	2	2
	207	FDIV	DRm,DRn	FE	1	(24, 25)/26	#41	F3	2	23
								F1	22	3
								F1	2	2
208	FLOAT	FPUL,DRn	FE	1	(3, 4)/5	#38	F1	2	2	
209	FMUL	DRm,DRn	FE	1	(7, 8)/9	#39	F1	2	6	

**Table 8.3 Execution Cycles (cont)**

Functional Category	No.	Instruction	Instruc- tion Group	Issue Rate	Latency	Execu- tion Pattern	Lock		
							Stage	Start	Cycles
Double- precision floating-point instructions	210	FNEG DRn	LS	1	0	#1	—	—	—
	211	FSQRT DRn	FE	1	(23, 24)/ 25	#41	F3	2	22
							F1	21	3
							F1	2	2
	212	FSUB DRm,DRn	FE	1	(7, 8)/9	#39	F1	2	6
213	FTRC DRm,FPUL	FE	1	4/5	#38	F1	2	2	
FPU system control instructions	214	LDS Rm,FPUL	LS	1	1	#1	—	—	—
	215	LDS Rm,FPSCR	CO	1	4	#32	F1	3	3
	216	LDS.L @Rm+,FPUL	CO	1	1/2	#2	—	—	—
	217	LDS.L @Rm+,FPSCR	CO	1	1/4	#33	F1	3	3
	218	STS FPUL,Rn	LS	1	3	#1	—	—	—
	219	STS FPSCR,Rn	CO	1	3	#1	—	—	—
	220	STS.L FPUL,@-Rn	CO	1	1/1	#2	—	—	—
	221	STS.L FPSCR,@-Rn	CO	1	1/1	#2	—	—	—
Graphics acceleration instructions	222	FMOV DRm,XDn	LS	1	0	#1	—	—	—
	223	FMOV XDm,DRn	LS	1	0	#1	—	—	—
	224	FMOV XDm,XDn	LS	1	0	#1	—	—	—
	225	FMOV @Rm,XDn	LS	1	2	#2	—	—	—
	226	FMOV @Rm+,XDn	LS	1	1/2	#2	—	—	—
	227	FMOV @(R0,Rm),XDn	LS	1	2	#2	—	—	—
	228	FMOV XDm,@Rn	LS	1	1	#2	—	—	—
	229	FMOV XDm,@-Rm	LS	1	1/1	#2	—	—	—
	230	FMOV XDm,@(R0,Rn)	LS	1	1	#2	—	—	—
	231	FIPR FVm,FVn	FE	1	4/5	#42	F1	3	1
	232	FRCHG	FE	1	1/4	#36	—	—	—
	233	FSCHG	FE	1	1/4	#36	—	—	—
	234	FTRV XMTRX,FVn	FE	1	(5, 5, 6, 7)/8	#43	F0	2	4
F1							3	4	

- Notes: 1. See table 8.1 for the instruction groups.  
2. Latency "L1/L2...": Latency corresponding to a write to each register, including MACH/MACL/FPSCR.  
Example: MOV.B @Rm+, Rn "1/2": The latency for Rm is 1 cycle, and the latency for Rn is 2 cycles.  
3. Branch latency: Interval until the branch destination instruction is fetched

4. Conditional branch latency "2 (or 1)": The latency is 2 for a nonzero displacement, and 1 for a zero displacement.
5. Double-precision floating-point instruction latency "(L1, L2)/L3": L1 is the latency for FR [n+1], L2 that for FR [n], and L3 that for FPSCR.
6. FTRV latency "(L1, L2, L3, L4)/L5": L1 is the latency for FR [n], L2 that for FR [n+1], L3 that for FR [n+2], L4 that for FR [n+3], and L5 that for FPSCR.
7. Latency "L1/L2/L3/L4" of MAC.L and MAC.W instructions: L1 is the latency for Rm, L2 that for Rn, L3 that for MACH, and L4 that for MACL.
8. Latency "L1/L2" of MUL.L, MULS.W, MULU.W, DMULS.L, and DMULU.L instructions: L1 is the latency for MACH, and L2 that for MACL.
9. Execution pattern: The instruction execution pattern number (see figure 8.2)
10. Lock/stage: Stage locked by the instruction
11. Lock/start: Locking start cycle; 1 is the first D-stage of the instruction.
12. Lock/cycles: Number of cycles locked

Exceptions:

1. When a floating-point computation instruction is followed by an FMOV store, an STS FPUL, Rn instruction, or an STS.L FPUL, @-Rn instruction, the latency of the floating-point computation is decreased by 1 cycle.
2. When the preceding instruction loads the shift amount of the following SHAD/SHLD, the latency of the load is increased by 1 cycle.
3. When an LS group instruction with a latency of less than 3 cycles is followed by a double-precision floating-point instruction, FIPR, or FTRV, the latency of the first instruction is increased to 3 cycles.  
Example: In the case of FMOV FR4,FR0 and FIPR FV0,FV4, FIPR is stalled for 2 cycles.
4. When MAC\*/MUL\*/DMUL\* is followed by an STS.L MAC\*, @-Rn instruction, the latency of MAC\*/MUL\*/DMUL\* is 5 cycles.
5. In the case of consecutive executions of MAC\*/MUL\*/DMUL\*, the latency is decreased to 2 cycles.
6. When an LDS to MAC\* is followed by an STS.L MAC\*, @-Rn instruction, the latency of the LDS to MAC\* is 4 cycles.
7. When an LDS to MAC\* is followed by MAC\*/MUL\*/DMUL\*, the latency of the LDS to MAC\* is 1 cycle.
8. When an FSCHG or FRCHG instruction is followed by an LS group instruction that reads or writes to a floating-point register, the aforementioned LS group instruction[s] cannot be executed in parallel.
9. When a single-precision FTRC instruction is followed by an STS FPUL, Rn instruction, the latency of the single-precision FTRC instruction is 1 cycle.

## Section 9 Power-Down Modes

### 9.1 Overview

In the power-down modes, some of the on-chip peripheral modules and the CPU functions are halted, enabling power consumption to be reduced.

#### 9.1.1 Types of Power-Down Modes

The following power-down modes and functions are provided:

- Sleep mode
- Deep sleep mode
- Standby mode
- Module standby function (TMU, RTC, SCI/SCIF, and DMAC on-chip peripheral modules)

Table 9.1 shows the conditions for entering these modes from the program execution state, the status of the CPU and peripheral modules in each mode, and the method of exiting each mode.



**Table 9.1 Status of CPU and Peripheral Modules in Power-Down Modes**

Power-Down Mode	Entering Conditions	Status							Exiting Method
		CPG	CPU	On-Chip Memory	On-chip Peripheral Modules	Pins	External Memory		
Sleep	SLEEP instruction executed while STBY bit is 0 in STBCR	Operating	Halted (registers held)	Held	Operating	Held	Refreshing	<ul style="list-style-type: none"> <li>• Interrupt</li> <li>• Reset</li> </ul>	
Deep sleep	SLEEP instruction executed while STBY bit is 0 in STBCR, and DSLP bit is 1 in STBCR2	Operating	Halted (registers held)	Held	Operating (DMA halted)	Held	Self-refreshing	<ul style="list-style-type: none"> <li>• Interrupt</li> <li>• Reset</li> </ul>	
Standby	SLEEP instruction executed while STBY bit is 1 in STBCR	Halted	Halted (registers held)	Held	Halted*	Held	Self-refreshing	<ul style="list-style-type: none"> <li>• Interrupt</li> <li>• Reset</li> </ul>	
Module standby	Setting MSTP bit to 1 in STBCR	Operating	Operating	Held	Specified modules halted*	Held	Refreshing	<ul style="list-style-type: none"> <li>• Clearing MSTP bit to 0</li> <li>• Reset</li> </ul>	

Note: The RTC operates when the START bit in RCR2 is 1 (see section 11, Realtime Clock (RTC), in the Hardware Manual).

### 9.1.2 Register Configuration

Table 9.2 shows the registers used for power-down mode control.

**Table 9.2 Power-Down Mode Registers**

Name	Abbreviation	R/W	Initial Value	P4 Address	Area 7 Address	Access Size
Standby control register	STBCR	R/W	H'00	H'FFC00004	H'1FC00004	8
Standby control register 2	STBCR2	R/W	H'00	H'FFC00010	H'1FC00010	8

## 9.2 Register Descriptions

### 9.2.1 Standby Control Register (STBCR)

The standby control register (STBCR) is an 8-bit readable/writable register that specifies the power-down mode status. It is initialized to H'00 by a power-on reset via the  $\overline{\text{RESET}}$  pin or due to watchdog timer overflow.

Bit:	7	6	5	4	3	2	1	0
	STBY	PHZ	PPU	MSTP4	MSTP3	MSTP2	MSTP1	MSTP0
Initial value:	0	0	0	0	0	0	0	0
R/W:	R/W	R/W	R/W	R/W	R/W	R/W	R/W	R/W

**Bit 7—Standby (STBY):** Specifies a transition to standby mode.

Bit 7: STBY	Description
0	Transition to sleep mode on execution of SLEEP instruction (Initial value)
1	Transition to standby mode on execution of SLEEP instruction

**Bit 6—Peripheral Module Pin High Impedance Control (PHZ):** Controls the state of peripheral module related pins in standby mode. When the PHZ bit is set to 1, peripheral module related pins go to the high-impedance state in standby mode.

For the relevant pins, see section 9.2.2, Peripheral Module Pin High Impedance Control.

Bit 6: PHZ	Description
0	Peripheral module related pins are in normal state (Initial value)
1	Peripheral module related pins go to high-impedance state

**Bit 5—Peripheral Module Pin Pull-Up Control (PPU):** Controls the state of peripheral module related pins. When the PPU bit is cleared to 0, the pull-up resistor is turned on for peripheral module related pins in the input or high-impedance state.

For the relevant pins, see section 9.2.3, Peripheral Module Pin Pull-Up Control.

Bit 5: PPU	Description
0	Peripheral module related pin pull-up resistors are on (Initial value)
1	Peripheral module related pin pull-up resistors are off

**Bit 4—Module Stop 4 (MSTP4):** Specifies stopping of the clock supply to the DMAC among the on-chip peripheral modules. The clock supply to the DMAC is stopped when the MSTP4 bit is set to 1. When DMA transfer is used, stop the transfer before setting the MSTP4 bit to 1. When DMA transfer is performed after clearing the MSTP4 bit to 0, DMAC settings must be made again.

Bit 4: MSTP4	Description
0	DMAC operates (Initial value)
1	DMAC clock supply is stopped

**Bit 3—Module Stop 3 (MSTP3):** Specifies stopping of the clock supply to serial communication interface channel 2 (SCIF) among the on-chip peripheral modules. The clock supply to the SCIF is stopped when the MSTP3 bit is set to 1.

Bit 3: MSTP3	Description
0	SCIF operates (Initial value)
1	SCIF clock supply is stopped

**Bit 2—Module Stop 2 (MSTP2):** Specifies stopping of the clock supply to the timer unit (TMU) among the on-chip peripheral modules. The clock supply to the TMU is stopped when the MSTP2 bit is set to 1.

Bit 2: MSTP2	Description
0	TMU operates (Initial value)
1	TMU clock supply is stopped

**Bit 1—Module Stop 1 (MSTP1):** Specifies stopping of the clock supply to the realtime clock (RTC) among the on-chip peripheral modules. The clock supply to the RTC is stopped when the MSTP1 bit is set to 1. When the clock supply is stopped, RTC registers cannot be accessed but the counters continue to operate.

Bit 1: MSTP1	Description	
0	RTC operates	(Initial value)
1	RTC clock supply is stopped	

**Bit 0—Module Stop 0 (MSTP0):** Specifies stopping of the clock supply to serial communication interface channel 1 (SCI) among the on-chip peripheral modules. The clock supply to the SCI is stopped when the MSTP0 bit is set to 1.

Bit 0: MSTP0	Description	
0	SCI operates	(Initial value)
1	SCI clock supply is stopped	

### 9.2.2 Peripheral Module Pin High Impedance Control

When bit 6 in the standby control register (STBCR) is set to 1, peripheral module related pins go to the high-impedance state in standby mode.

- Relevant Pins

SCI related pins	MD0/SCK	MD1/TXD2
	MD7/TXD	MD8/RTS2
	CTS2	
DMA related pins	DACK0	DRAK0
	DACK1	DRAK1

- Other Information

High impedance control is not performed when the above pins are used as port output pins.

### 9.2.3 Peripheral Module Pin Pull-Up Control

When bit 5 in the standby control register (STBCR) is cleared to 0, peripheral module related pins are pulled up when in the input or high-impedance state.

- Relevant Pins

SCI related pins	MD0/SCK	MD1/TXD2	MD2/RXD2
	MD7/TXD	MD8/RTS2	SCK2/MRESET
	RXD	CTS2	
DMA related pins	DREQ $\bar{0}$	DACK0	DRAK0
	DREQ $\bar{1}$	DACK1	DRAK1
TMU related pin	TCLK		

### 9.2.4 Standby Control Register 2 (STBCR2)

Standby control register 2 (STBCR2) is an 8-bit readable/writable register that specifies the sleep mode and deep sleep mode transition conditions. It is initialized to H'00 by a power-on reset via the  $\overline{\text{RESET}}$  pin or due to watchdog timer overflow.

Bit:	7	6	5	4	3	2	1	0
	DSL $\bar{P}$	—	—	—	—	—	—	—
Initial value:	0	0	0	0	0	0	0	0
R/W:	R/W	R	R	R	R	R	R	R

**Bit 7—Deep Sleep (DSL $\bar{P}$ ):** Specifies a transition to deep sleep mode

Bit 7: DSL $\bar{P}$	Description
0	Transition to sleep mode or standby mode on execution of SLEEP instruction, according to setting of STBY bit in STBCR register (Initial value)
1	Transition to deep sleep mode on execution of SLEEP instruction*

Note: \* When the STBY bit in the STBCR register is 0

**Bits 6 to 0—Reserved:** Only 0 should only be written to these bits; operation cannot be guaranteed if 1 is written. These bits are always read as 0.

## 9.3 Sleep Mode

### 9.3.1 Transition to Sleep Mode

If a SLEEP instruction is executed when the STBY bit in STBCR is cleared to 0, the chip switches from the program execution state to sleep mode. After execution of the SLEEP instruction, the CPU halts but its register contents are retained. The on-chip peripheral modules continue to operate, and the clock continues to be output from the CKIO pin.

In sleep mode, a high-level signal is output at the STATUS1 pin, and a low-level signal at the STATUS0 pin.

### 9.3.2 Exit from Sleep Mode

Sleep mode is exited by means of an interrupt (NMI, IRL, or on-chip peripheral module) or a reset. In sleep mode, interrupts are accepted even if the BL bit in the SR register is 1. If necessary, SPC and SSR should be saved to the stack before executing the SLEEP instruction.

**Exit by Interrupt:** When an NMI, IRL, or on-chip peripheral module interrupt is generated, sleep mode is exited and interrupt exception handling is executed. The code corresponding to the interrupt source is set in the INTEVT register.

**Exit by Reset:** Sleep mode is exited by means of a power-on or manual reset via the  $\overline{\text{H}}$  pin, or a power-on or manual reset executed when the watchdog timer overflows.

## 9.4 Deep Sleep Mode

### 9.4.1 Transition to Deep Sleep Mode

If a SLEEP instruction is executed when the STBY bit in STBCR is cleared to 0 and the DSLP bit in STBCR2 is set to 1, the chip switches from the program execution state to deep sleep mode. After execution of the SLEEP instruction, the CPU halts but its register contents are retained. Except for the DMAC, on-chip peripheral modules continue to operate, and the clock continues to be output from the CKIO pin.

In deep sleep mode, a high-level signal is output at the STATUS1 pin, and a low-level signal at the STATUS0 pin.

### 9.4.2 Exit from Deep Sleep Mode

As with sleep mode, deep sleep mode is exited by means of an interrupt (NMI, IRL, or on-chip peripheral module) or a reset.

## 9.5 Standby Mode

### 9.5.1 Transition to Standby Mode

If a SLEEP instruction is executed when the STBY bit in STBCR is set to 1, the chip switches from the program execution state to standby mode. In standby mode, the on-chip peripheral modules halt as well as the CPU. Clock output from the CKIO pin is also stopped.

The CPU and cache register contents are retained. Some on-chip peripheral module registers are initialized. The state of the peripheral module registers in standby mode is shown in table 9.4.

**Table 9.4 State of Registers in Standby Mode**

Module	Initialized Registers	Registers That Retain Their Contents
Interrupt controller	—	All registers
User break controller	—	All registers
Bus state controller	—	All registers
On-chip oscillation circuits	—	All registers
Timer unit	TSTR register*	All registers except TSTR
Realtime clock	—	All registers
Direct memory access controller	—	All registers
Serial communication interface	See Appendix A, Address List	See Appendix A, Address List

Note: \* Not initialized when the realtime clock (RTC) is in use (see section 12, Timer Unit (TMU), in the Hardware Manual).

Note: DMA transfer should be terminated before making a transition to standby mode. Transfer results are not guaranteed if standby mode is entered during transfer.

The procedure for a transition to standby mode is shown below.

1. Clear the TME bit in the WDT timer control register (WTCSR) to 0, and stop the WDT.  
Set the initial value for the up-count in the WDT timer counter (WTCNT), and set the clock to be used for the up-count in bits CKS2–CKS0 in the WTCSR register.
2. Set the STBY bit in the STBCR register to 1, then execute a SLEEP instruction.
3. When standby mode is entered and the chip's internal clock stops, a low-level signal is output at the STATUS1 pin, and a high-level signal at the STATUS0 pin.

### 9.5.2 Exit from Standby Mode

Standby mode is exited by means of an interrupt (NMI, IRL, or on-chip peripheral module) or a reset via the  $\overline{\text{RESET}}$  pin.

**Exit by Interrupt:** A hot start can be performed by means of the on-chip WDT. When an NMI, IRL<sup>\*1</sup>, or on-chip peripheral module (except interval timer)<sup>\*2</sup> interrupt is detected, the WDT starts counting. After the count overflows, clocks are supplied to the entire chip, standby mode is exited, and the STATUS1 and STATUS0 pins both go low. Interrupt exception handling is then executed, and the code corresponding to the interrupt source is set in the INTEVT register. In standby mode, interrupts are accepted even if the BL bit in the SR register is 1, and so, if necessary, SPC and SSR should be saved to the stack before executing the SLEEP instruction.

The phase of the CKIO pin clock output may be unstable immediately after an interrupt is detected, until standby mode is exited.

- Notes: 1. Only when the RTC clock (32.768 kHz) is operating (see section 19.2.2, IRL Interrupts, in the Hardware Manual), standby mode can be exited by means of IRL3–IRL0 (when the IRL3–IRL0 level is higher than the SR register I3–I0 mask level).
2. Standby mode can be exited by means of an RTC interrupt.

**Exit by Reset:** Standby mode is exited by means of a reset (power-on or manual) via the  $\overline{\text{RESET}}$  pin. The  $\overline{\text{RESET}}$  pin should be held low until clock oscillation stabilizes. The internal clock continues to be output at the CKIO pin.

### 9.5.3 Clock Pause Function

In standby mode, it is possible to stop or change the frequency of the clock input from the EXTAL pin. This function is used as follows.

1. Enter standby mode following the transition procedure described above.
2. When standby mode is entered and the chip's internal clock stops, a low-level signal is output at the STATUS1 pin, and a high-level signal at the STATUS0 pin.
3. The input clock is stopped, or its frequency changed, after the STATUS1 pin goes low and the STATUS0 pin high.
4. When the frequency is changed, input an NMI or IRL interrupt after the change. When the clock is stopped, input an NMI or IRL interrupt after applying the clock.
5. After the time set in the WDT, clock supply begins inside the chip, the STATUS1 and STATUS0 pins both go low, and operation is resumed from interrupt exception handling.



## 9.6 Module Standby Function

### 9.6.1 Transition to Module Standby Function

Setting the MSTP4–MSTP0 bits in the standby control register to 1 enables the clock supply to the corresponding on-chip peripheral modules to be halted. Use of this function allows power consumption in sleep mode to be further reduced.

In the module standby state, the on-chip peripheral module external pins retain their states prior to halting of the modules, and most registers retain their states prior to halting of the modules.

Bit		Description
MSTP4	0	DMAC operates
	1	Clock supplied to DMAC is stopped
MSTP3	0	SCIF operates
	1	Clock supplied to SCIF is stopped
MSTP2	0	TMU operates
	1	Clock supplied to TMU is stopped, and register is initialized* <sup>1</sup>
MSTP1	0	RTC operates
	1	Clock supplied to RTC is stopped* <sup>2</sup>
MSTP0	0	SCI operates
	1	Clock supplied to SCI is stopped

- Notes:
1. The register initialized is the same as in standby mode, but initialization is not performed if the RTC clock is not in use (see section 12, Timer Unit (TMU), in the Hardware Manual).
  2. The counter operates when the START bit in RCR2 is 1 (see section 11, Realtime Clock (RTC), in the Hardware Manual).

### 9.6.2 Exit from Module Standby Function

The module standby function is exited by clearing the MSTP4–MSTP0 bits to 0, or by a power-on reset via the  $\overline{\text{RESET}}$  pin or a power-on reset caused by watchdog timer overflow.

## Section 10 Instruction Descriptions

Instructions are listed in this section in alphabetical order. The following format is used for the instruction descriptions.

<b>Instruction Name</b>	<b>Full Name</b>	<b>Instruction Type</b>
Function		(Indication of delayed branch instruction or interrupt-disabling instruction)

---

<b>Format</b>	<b>Summary of Operation</b>	<b>Instruction Code</b>	<b>Execution States</b>	<b>T Bit</b>
The assembler input format is shown. imm and disp are numeric values, expressions, or symbols.	Summarizes the operation of the instruction.	Shown in MSB ←→ LSB order.	The no-wait value is shown.	Shows the T bit value after execution of the instruction.

### **Description**

Describes the operation of the instruction.

### **Notes**

Identifies points to be noted when using the instruction.

### **Operation**

Shows the operation in C. This is given as reference material to help understand the operation of the instruction. Use of the following resources is assumed.

```

char      8-bit integer
short    16-bit integer
int      32-bit integer
long     64-bit integer
float    single-precision floating point number(32 bits)
double   double-precision floating point number(64 bits)

```

These are data types.

```
unsigned char  Read_Byte(unsigned long Addr);
unsigned short Read_Word(unsigned long Addr);
unsigned long  Read_Long(unsigned long Addr);
```

These reflect the respective sizes of address Addr. A word read from other than a 2n address, or a longword read from other than a 4n address, will be detected as an address error.

```
unsigned char Write_Byte(unsigned long Addr, unsigned long Data);
unsigned short Write_Word(unsigned long Addr, unsigned long Data);
unsigned long Write_Long(unsigned long Addr, unsigned long Data);
```

These write data Data to address Addr, using the respective sizes. A word write to other than a 2n address, or a longword write to other than a 4n address, will be detected as an address error.

```
Delay_Slot(unsigned long Addr);
```

Shifts to execution of the slot instruction at address (Addr).

```
unsigned long R[16];
unsigned long SR,GBR,VBR;
unsigned long MACH,MACL,PR;
unsigned long PC;
```

#### Registers

```
struct SR0 {
    unsigned long dummy0:22;
    unsigned long    M0:1;
    unsigned long    Q0:1;
    unsigned long    I0:4;
    unsigned long dummy1:2;
    unsigned long    S0:1;
    unsigned long    T0:1;
};
```

SR structure definitions

```
define M ((*(struct SR0 *)&SR).M0)
#define Q ((*(struct SR0 *)&SR).Q0)
#define S ((*(struct SR0 *)&SR).S0)
#define T ((*(struct SR0 *)&SR).T0)
```

Definitions of bits in SR

```
Error( char *er );
```

Error display function

These are floating-point number definition statements.

```
#define PZERO      0
#define NZERO     1
#define DENORM    2
#define NORM      3
#define PINF      4
#define NINF      5
#define qNaN      6
#define sNaN      7
#define EQ        0
#define GT        1
#define LT        2
#define UO        3
#define INVALID   4
#define FADD      0
#define FSUB      1

#define CAUSE      0x0003f000 /* FPSCR(bit17-12) */
#define SET_E      0x00020000 /* FPSCR(bit17) */
#define SET_V      0x00010040 /* FPSCR(bit16,6) */
#define SET_Z      0x00008020 /* FPSCR(bit15,5) */
#define SET_O      0x00004010 /* FPSCR(bit14,4) */
#define SET_U      0x00002008 /* FPSCR(bit13,3) */
#define SET_I      0x00001004 /* FPSCR(bit12,2) */
#define ENABLE_VOUI 0x00000b80 /* FPSCR(bit11,9-7) */
#define ENABLE_V    0x00000800 /* FPSCR(bit11) */
#define ENABLE_Z    0x00000400 /* FPSCR(bit10) */
#define ENABLE_OUI  0x00000380 /* FPSCR(bit9-7) */
#define ENABLE_I    0x00000080 /* FPSCR(bit7) */
#define FLAG       0x0000007C /* FPSCR(bit6-2) */

#define FPSCR_FR   FPSCR>>21&1
#define FPSCR_PR   FPSCR>>19&1
#define FPSCR_DN   FPSCR>>18&1
```

```

#define FPSCR_I      FPSCR>>12&1
#define FPSCR_RM     FPSCR&1
#define FR_HEX      frf.l[ FPSCR_FR]
#define FR          frf.f[ FPSCR_FR]
#define DR          frf.d[ FPSCR_FR]
#define XF_HEX      frf.l[~FPSCR_FR]
#define XF          frf.f[~FPSCR_FR]
#define XD          frf.d[~FPSCR_FR]

union {
    int  l[2][16];
    float f[2][16];
    double d[2][8];
} frf;
int FPSCR;

int sign_of(int n)
{
    return(FR_HEX[n]>>31);
}

int data_type_of(int n) {
int abs;
    abs = FR_HEX[n] & 0x7fffffff;
    if(FPSCR_PR == 0) { /* Single-precision */
        if(abs < 0x00800000){
            if((FPSCR_DN == 1) || (abs == 0x00000000)){
                if(sign_of(n) == 0) {zero(n, 0); return(PZERO);}
                else                {zero(n, 1); return(NZERO);}
            }
            else                    return(DENORM);
        }
        else if(abs < 0x7f800000)   return(NORM);
        else if(abs == 0x7f800000) {
            if(sign_of(n) == 0)     return(PINF);
            else                    return(NINF);
        }
        else if(abs < 0x7fc00000)   return(qNaN);
    }
}

```

```

        else
            return(sNaN);
    }
else { /* Double-precision */
    if(abs < 0x00100000){
        if((FPSCR_DN == 1) ||
            ((abs == 0x00000000) && (FR_HEX[n+1] == 0x00000000))){
            if(sign_of(n) == 0) {zero(n, 0); return(PZERO);}
            else
                {zero(n, 1); return(NZERO);}
        }
        else
            return(DENORM);
    }
    else if(abs < 0x7ff00000) return(NORM);
    else if((abs == 0x7ff00000) &&
        (FR_HEX[n+1] == 0x00000000)) {
        if(sign_of(n) == 0) return(PINF);
        else
            return(NINF);
    }
    else if(abs < 0x7ff80000) return(qNaN);
    else
        return(sNaN);
}
}

void register_copy(int m,n)
{
    FR[n] = FR[m];
    if(FPSCR_PR == 1) FR[n+1] = FR[m+1];
}

void normal_faddsub(int m,n,type)
{
    union {
        float f;
        int l;
    } dstf,srcf;
    union {
        long d;
        int l[2];
    } dstd,srcd;
    union { /* "long double" format: */

```

```

long double x; /* 1-bit sign */
int l[4]; /* 15-bit exponent */
} dstx; /* 112-bit mantissa */
if(FPSCR_PR == 0) {
    if(type == FADD) srcf.f = FR[m];
    else srcf.f = -FR[m];
    dstd.d = FR[n]; /* Conversion from single-precision to double-precision */
    dstd.d += srcf.f;
    if(((dstd.d == FR[n]) && (srcf.f != 0.0)) ||
        ((dstd.d == srcf.f) && (FR[n] != 0.0))) {
        set_I();
        if(sign_of(m)^ sign_of(n)) {
            dstd.l[1] -= 1;
            if(dstd.l[1] == 0xffffffff) dstd.l[0] -= 1;
        }
    }
    if(dstd.l[1] & 0x1fffffff) set_I();
    dstf.f += srcf.f; /* Round to nearest */
    if(FPSCR_RM == 1) {
        dstd.l[1] &= 0xe0000000; /* Round to zero */
        dstf.f = dstd.d;
    }
    check_single_exception(&FR[n],dstf.f);
} else {
    if(type == FADD) srcd.d = DR[m>>1];
    else srcd.d = -DR[m>>1];
    dstx.x = DR[n>>1];
    /* Conversion from double-precision to extended double-precision */
    dstx.x += srcd.d;
    if(((dstx.x == DR[n>>1]) && (srcd.d != 0.0)) ||
        ((dstx.x == srcd.d) && (DR[n>>1] != 0.0)) ) {
        set_I();
        if(sign_of(m)^ sign_of(n)) {
            dstx.l[3] -= 1;
            if(dstx.l[3] == 0xffffffff) {dstx.l[2] -= 1;
            if(dstx.l[2] == 0xffffffff) {dstx.l[1] -= 1;
            if(dstx.l[1] == 0xffffffff) {dstx.l[0] -= 1;}}}
        }
    }
}

```

```

        }
    }
    if((dstx.l[2] & 0x0fffffff) || dstx.l[3]) set_I();
    dst.d += srcd.d; /* Round to nearest */
    if(FPSCR_RM == 1) {
        dstx.l[2] &= 0xf0000000; /* Round to zero */
        dstx.l[3] = 0x00000000;
        dst.d = dstx.x;
    }
    check_double_exception(&DR[n>>1] ,dst.d);
}
}
void normal_fmuls(int m,n)
{
union {
    float f;
    int l;
} tmpf;
union {
    double d;
    int l[2];
} tmpd;
union {
    long double x;
    int l[4];
} tmpx;
if(FPSCR_PR == 0) {
    tmpd.d = FR[n]; /* Single-precision to double-precision */
    tmpd.d *= FR[m]; /* Precise creation */
    tmpf.f *= FR[m]; /* Round to nearest */
    if(tmpf.f != tmpd.d) set_I();
    if((tmpf.f > tmpd.d) && (FPSCR_RM == 1)) {
        tmpf.l -= 1; /* Round to zero */
    }
    check_single_exception(&FR[n],tmpf.f);
} else {
    tmpx.x = DR[n>>1]; /* Single-precision to double-precision */

```



```

    tmpx.x *= DR[m>>1]; /* Precise creation */
    tmpd.d *= DR[m>>1]; /* Round to nearest */
    if(tmpd.d != tmpx.x) set_I();
    if(tmpd.d > tmpx.x) && (FPSCR_RM == 1) {
        tmpd.l[1] -= 1; /* Round to zero */
        if(tmpd.l[1] == 0xffffffff) tmpd.l[0] -= 1;
    }
    check_double_exception(&DR[n>>1], tmpd.d);
}
}
void fipr(int m,n)
{
union {
    double d;
    int l[2];
} ml[4];
float dstf;
    if((data_type_of(m) == sNaN) || (data_type_of(n) == sNaN) ||
        (data_type_of(m+1) == sNaN) || (data_type_of(n+1) == sNaN) ||
        (data_type_of(m+2) == sNaN) || (data_type_of(n+2) == sNaN) ||
        (data_type_of(m+3) == sNaN) || (data_type_of(n+3) == sNaN) ||
        (check_product_invalid(m,n) ||
        (check_product_invalid(m+1,n+1) ||
        (check_product_invalid(m+2,n+2) ||
        (check_product_invalid(m+3,n+3)) )    invalid(n+3);
    else if((data_type_of(m) == qNaN) || (data_type_of(n) == qNaN) ||
        (data_type_of(m+1) == qNaN) || (data_type_of(n+1) == qNaN) ||
        (data_type_of(m+2) == qNaN) || (data_type_of(n+2) == qNaN) ||
        (data_type_of(m+3) == qNaN) || (data_type_of(n+3) == qNaN))
qnan(n+3);
    else if (check_positive_infinity() &&
        (check_negative_infinity()    invalid(n+3);
    else if (check_positive_infinity()    inf(n+3,0);
    else if (check_negative_infinity()    inf(n+3,1);
    else {
        for(i=0;i<4;i++) {
            /* If FPSCR_DN == 1, zeroize */
            if (data_type_of(m+i) == PZERO) FR[m+i] = +0.0;

```

```

        else if(data_type_of(m+i) == NZERO)  FR[m+i] = -0.0;
        if      (data_type_of(n+i) == PZERO)  FR[n+i] = +0.0;
        else if(data_type_of(n+i) == NZERO)  FR[n+i] = -0.0;
        mlt[i].d = FR[m+i];
        mlt[i].d *= FR[n+i];

/* To be precise, with FIPR, the lower 18 bits are discarded; therefore, this description
is simplified, and differs from the hardware. */
        mlt[i].l[1] &= 0xff000000;
        mlt[i].l[1] |= 0x00800000;
    }
    mlt[0].d += mlt[1].d + mlt[2].d + mlt[3].d;
    mlt[0].l[1] &= 0xff800000;
    dstf = mlt[0].d;
    set_I();
    check_single_exception(&FR[n+3],dstf);
}
}
void check_single_exception(float *dst,result)
{
union {
    float f;
    int l;
} tmp;
float abs;
if(result < 0.0) tmp.l = 0xff800000; /* -infinity */
else tmp.l = 0x7f800000; /* +infinity */
if(result == tmp.f) {
    set_O(); set_I();
    if(FPSCR_RM == 1) {
        tmp.l -= 1; /* Maximum value of normalized number */
        result = tmp.f;
    }
}
if(result < 0.0) abs = -result;
else abs = result;
tmp.l = 0x00800000; /* Minimum value of normalized number */

```

```

if(abs < tmp.f) {
    if((FPSCR_DN == 1) && (abs != 0.0)) {
        set_I();
        if(result < 0.0) result = -0.0; /* Zeroize denormalized number */
        else
            result = 0.0;
    }
    if(FPSCR_I == 1) set_U();
}
if(FPSCR & ENABLE_OUI) fpu_exception_trap();
else
    *dst = result;
}

void check_double_exception(double *dst,result)
{
union {
    double d;
    int l[2];
} tmp;
double abs;
if(result < 0.0) tmp.l[0] = 0xfff00000; /* -infinity */
else
    tmp.l[0] = 0x7ff00000; /* +infinity */
    tmp.l[1] = 0x00000000;

if(result == tmp.d)
    set_O(); set_I();
    if(FPSCR_RM == 1) {
        tmp.l[0] -= 1;
        tmp.l[1] = 0xffffffff;
        result = tmp.d; /* Maximum value of normalized number */
    }
}
if(result < 0.0) abs = -result;
else
    abs = result;
tmp.l[0] = 0x00100000; /* Minimum value of normalized number */
tmp.l[1] = 0x00000000;
if(abs < tmp.d) {
    if((FPSCR_DN == 1) && (abs != 0.0)) {
        set_I();
        if(result < 0.0) result = -0.0;
    }
}

```

```

                                /* Zeroize denormalized number */
                                else          result = 0.0;
                                }
                                if(FPSCR_I == 1) set_U();
                                }
                                if(FPSCR & ENABLE_OUI) fpu_exception_trap();
                                else          *dst = result;
                                }
int check_product_invalid(int m,n)
{
    return(check_product_infinity(m,n)  &&
           ((data_type_of(m) == PZERO) || (data_type_of(n) == PZERO) ||
            (data_type_of(m) == NZERO) || (data_type_of(n) == NZERO)));
}
int check_ product_infinity(int m,n)
{
    return((data_type_of(m) == PINF) || (data_type_of(n) == PINF) ||
           (data_type_of(m) == NINF) || (data_type_of(n) == NINF));
}
int check_ positive_infinity(int m,n)
{
    return(((check_ product_infinity(m,n) && (~sign_of(m)^
sign_of(n))) ||
           ((check_ product_infinity(m+1,n+1) && (~sign_of(m+1)^
sign_of(n+1))) ||
           ((check_ product_infinity(m+2,n+2) && (~sign_of(m+2)^
sign_of(n+2))) ||
           ((check_ product_infinity(m+3,n+3) && (~sign_of(m+3)^
sign_of(n+3)))));
}
int check_ negative_infinity(int m,n)
{
    return(((check_ product_infinity(m,n) && (sign_of(m)^ sign_of(n))) ||
           ((check_ product_infinity(m+1,n+1) && (sign_of(m+1)^
sign_of(n+1))) ||
           ((check_ product_infinity(m+2,n+2) && (sign_of(m+2)^
sign_of(n+2))) ||
           ((check_ product_infinity(m+3,n+3) && (sign_of(m+3)^
sign_of(n+3)))));
}

```

```

}
void clear_cause () {FPSCR &= ~CAUSE;}
void set_E() {FPSCR |= SET_E; fpu_exception_trap();}
void set_V() {FPSCR |= SET_V;}
void set_Z() {FPSCR |= SET_Z;}
void set_O() {FPSCR |= SET_O;}
void set_U() {FPSCR |= SET_U;}
void set_I() {FPSCR |= SET_I;}
void invalid(int n)
{
    set_V();
    if((FPSCR & ENABLE_V) == 0 qnan(n);
    else    fpu_exception_trap();
}

void dz(int n,sign)
{
    set_Z();
    if((FPSCR & ENABLE_Z) == 0 inf(n,sign);
    else    fpu_exception_trap();
}

void zero(int n,sign)
{
    if(sign == 0)    FR_HEX [n]    = 0x00000000;
    else            FR_HEX [n]    = 0x80000000;
    if (FPSCR_PR==1) FR_HEX [n+1] = 0x00000000;
}

void inf(int n,sign) {
    if (FPSCR_PR==0) {
        if(sign == 0) FR_HEX [n]    = 0x7f800000;
        else          FR_HEX [n]    = 0xff800000;
    } else {
        if(sign == 0) FR_HEX [n]    = 0x7ff00000;
        else          FR_HEX [n]    = 0xfff00000;
        FR_HEX [n+1] = 0x00000000;
    }
}
}

```

```

void qnan(int n)
{
    if (FPSCR_PR==0) FR[n] = 0x7fbfffff;
    else {
        FR[n] = 0x7ff7ffff;
        FR[n+1] = 0xffffffff;
    }
}

```

### Example

An example is shown using assembler mnemonics, indicating the states before and after execution of the instruction.

Italics (e.g., *.align*) indicate an assembler control instruction. The meaning of the assembler control instructions is given below. For details, refer to the Cross-Assembler User's Manual.

<i>.org</i>	Location counter setting
<i>.data.w</i>	Word integer data allocation
<i>.data.l</i>	Longword integer data allocation
<i>.sdata</i>	String data allocation
<i>.align 2</i>	2-byte boundary alignment
<i>.align 4</i>	4-byte boundary alignment
<i>.align 32</i>	32-byte boundary alignment
<i>.arepeat 16</i>	16-times repeat expansion
<i>.arepeat 32</i>	32-times repeat expansion
<i>.aendr</i>	Count-specification repeat expansion end

Note: SH Series cross-assembler version 1.0 does not support conditional assembler functions.

## 10.1 ADD ADD binary

Binary Addition

## Arithmetic Instruction

Format	Summary of Operation	Instruction Code	Execution States	T Bit
ADD Rm,Rn	Rn+Rm → Rn	0011nnnnmmmm1100	1	—
ADD #imm,Rn	Rn+imm → Rn	0111nnnniiiiiii	1	—

### Description

This instruction adds together the contents of general registers Rn and Rm and stores the result in Rn.

8-bit immediate data can also be added to the contents of general register Rn.

8-bit immediate data is sign-extended to 32 bits, allowing use in decrement operations.

### Operation

```
ADD(long m, long n) /* ADD Rm,Rn */
{
    R[n]+=R[m];
    PC+=2;
}

ADDI(long i, long n) /* ADD #imm,Rn */
{
    if ((i&0x80)==0)
        R[n]+=(0x000000FF & (long)i);
    else R[n]+=(0xFFFFFFFF | (long)i);
    PC+=2;
}
```

### Example

```
ADD R0,R1           ; Before execution R0 = H'7FFFFFFF, R1 = H'00000001
                    ; After execution  R1 = H'80000000
ADD #H'01,R2        ; Before execution R2 = H'00000000
                    ; After execution  R2 = H'00000001
ADD #H'FE,R3        ; Before execution R3 = H'00000001
                    ; After execution  R3 = H'FFFFFFF
```



**10.2 ADDC      ADD with Carry**  
 Binary Addition  
 with Carry

**Arithmetic Instruction**

Format	Summary of Operation	Instruction Code	Execution States	T Bit
ADDC Rm,Rn	Rn+Rm+T → Rn, carry → T	0011nnnnmmmm1110	1	Carry

**Description**

This instruction adds together the contents of general registers Rn and Rm and the T bit, and stores the result in Rn. A carry resulting from the operation is reflected in the T bit. This instruction is used for additions exceeding 32 bits.

**Operation**

```
ADDC(long m, long n)    /* ADDC Rm,Rn */
{
    unsigned long tmp0,tmp1;

    tmp1=R[n]+R[m];
    tmp0=R[n];
    R[n]=tmp1+T;
    if (tmp0>tmp1) T=1;
    else T=0;
    if (tmp1>R[n]) T=1;
    PC+=2;
}
```

**Example**

```
CLRT                ; R0:R1(64 bits) + R2:R3(64 bits) = R0:R1(64 bits)
ADDC  R3,R1         ; Before execution  T = 0, R1 = H'00000001, R3 = H'FFFFFFF
                   ; After execution   T = 1, R1 = H'00000000
ADDC  R2,R0         ; Before execution  T = 1, R0 = H'00000000, R2 = H'00000000
                   ; After execution   T = 0, R0 = H'00000001
```

### 10.3 ADDV ADD with (V flag) overflow check Arithmetic Instruction

Binary Addition  
with Overflow Check

---

Format	Summary of Operation	Instruction Code	Execution States	T Bit
ADDV Rm,Rn	Rn+Rm → Rn, overflow → T	0011nnnnmmmm1111	1	Overflow

---

#### Description

This instruction adds together the contents of general registers Rn and Rm and stores the result in Rn. If overflow occurs, the T bit is set.

#### Operation

```

ADDV(long m, long n)    /* ADDV Rm,Rn */
{
    long dest,src,ans;

    if ((long)R[n]>=0) dest=0;
    else dest=1;
    if ((long)R[m]>=0) src=0;
    else src=1;
    src+=dest;
    R[n]+=R[m];
    if ((long)R[n]>=0) ans=0;
    else ans=1;
    ans+=dest;
    if (src==0 || src==2) {
        if (ans==1) T=1;
        else T=0;
    }
    else T=0;
    PC+=2;
}

```

### Example

```
ADDV R0,R1 ; Before execution R0 = H'00000001, R1 = H'7FFFFFFE, T=0
          ; After execution R1 = H'7FFFFFFF, T=0
ADDV R0,R1 ; Before execution R0 = H'00000002, R1 = H'7FFFFFFE, T=0
          ; After execution R1 = H'80000000, T=1
```

## 10.4 AND

## AND logical

## Logical Instruction

Logical AND

---

Format	Summary of Operation	Instruction Code	Execution States	T Bit
AND Rm,Rn	Rm & Rm → Rn	0010nnnnmmmm1001	1	—
AND #imm,R0	R0 & imm → R0	11001001iiiiiii	1	—
AND.B #imm,@(R0,GBR)	(R0+GBR) & imm → (R0+GBR)	11001101iiiiiii	4	—

---

### Description

This instruction ANDs the contents of general registers Rn and Rm and stores the result in Rn.

This instruction can be used to AND general register R0 contents with zero-extended 8-bit immediate data, or, in indexed GBR indirect addressing mode, to AND 8-bit memory with 8-bit immediate data.

### Notes

With AND #imm,R0, the upper 24 bits of R0 are always cleared as a result of the operation.

### Operation

```
AND(long m, long n)    /* AND Rm,Rn */
{
    R[n]&=R[m];
    PC+=2;
}

ANDI(long i)           /* AND #imm,R0 */
{
    R[0]&=(0x000000FF & (long)i);
    PC+=2;
}

ANDM(long i)           /* AND.B #imm,@(R0,GBR) */
{
    long temp;

    temp=(long)Read_Byte(GBR+R[0]);
```

Rev. 3.0, 09/99, page 205 of 396

**HITACHI**

```

temp&=(0x000000FF & (long)i);
Write_Byte(GBR+R[0],temp);
PC+=2;
}

```

### Example

```

AND    R0,R1           ; Before execution R0 = H'AAAAAAAA, R1=H'55555555
                          ; After execution R1 = H'00000000
AND    #H'0F,R0        ; Before execution R0 = H'FFFFFFFF
                          ; After execution R0 = H'0000000F
AND.B  #H'80,@(R0,GBR) ; Before execution (R0,GBR) = H'A5
                          ; After execution (R0,GBR) = H'80

```

## 10.5 BF Branch if False

Conditional Branch

## Branch Instruction

---

Format	Summary of Operation	Instruction Code	Execution States	T Bit
BF label	If T = 0 PC + 4 + disp × 2 → PC If T = 1, nop	10001011ddddddd	1	—

---

### Description

This is a conditional branch instruction that references the T bit. The branch is taken if T = 0, and not taken if T = 1. The branch destination is address (PC + 4 + displacement × 2). The PC source value is the BF instruction address. As the 8-bit displacement is multiplied by two after sign-extension, the branch destination can be located in the range from -256 to +254 bytes from the BF instruction.

### Notes

If the branch destination cannot be reached, the branch must be handled by using BF in combination with a BRA or JMP instruction, for example.

### Operation

```
BF(int d) /* BF disp */
{
    int disp;

    if ((d&0x80)==0)
        disp=(0x000000FF & d);
    else    disp=(0xFFFFFFFF00 | d);
    if (T==0)
        PC=PC+4+(disp<<1);
    else    PC+=2;
}
```

### Example

```
CLRT                ; Normally T = 0
BT   TRGET_T        ; T = 0, so branch is not taken.
BF   TRGET_F        ; T = 0, so branch to TRGET_F.
NOP                ;
NOP                ;
TRGET_F:           ; ← BF instruction branch destination
```

**10.6 BF/S Branch if False with delay Slot**  
Conditional Branch with Delay

**Branch Instruction**  
Delayed Branch Instruction

---

<b>Format</b>	<b>Summary of Operation</b>	<b>Instruction Code</b>	<b>Execution States</b>	<b>T Bit</b>
BF/S label	If T = 0 PC + 4 + disp × 2 → PC If T = 1, nop	10001111ddddddd	1	—

---

**Description**

This is a delayed conditional branch instruction that references the T bit. If T = 1, the next instruction is executed and the branch is not taken. If T = 0, the branch is taken after execution of the next instruction.

The branch destination is address (PC + 4 + displacement × 2). The PC source value is the BF/S instruction address. As the 8-bit displacement is multiplied by two after sign-extension, the branch destination can be located in the range from -256 to +254 bytes from the BF/S instruction.

**Notes**

As this is a delayed branch instruction, when the branch condition is satisfied, the instruction following this instruction is executed before the branch destination instruction.

Interrupts are not accepted between this instruction and the following instruction.

If the following instruction is a branch instruction, it is identified as a slot illegal instruction.

If this instruction is located in the delay slot immediately following a delayed branch instruction, it is identified as a slot illegal instruction.

If the branch destination cannot be reached, the branch must be handled by using BF/S in combination with a BF, BRA, or JMP instruction, for example.



## Operation

```
BFS(int d)    /* BFS disp */
{
    int disp;
    unsigned int temp;

    temp=PC;
    if ((d&0x80)==0)
        disp=(0x000000FF & d);
    else    disp=(0xFFFFFFFF00 | d);
    if (T==0)
        PC=PC+4+(disp<<1);
    else PC+=4;
    Delay_Slot(temp+2);
}
```

## Example

```
CLRT                ; Normally T = 0
BT/S  TRGET_T        ; T = 0, so branch is not taken.
NOP                 ;
BF/S  TRGET_F        ; T = 0, so branch to TRGET.
ADD   R0, R1        ; Executed before branch.
NOP                 ;
TRGET_F:            ; ← BF/S instruction branch destination
```

**10.7 BRA BRAnch**  
Unconditional Branch

**Branch Instruction**  
Delayed Branch Instruction

---

<b>Format</b>	<b>Summary of Operation</b>	<b>Instruction Code</b>	<b>Execution States</b>	<b>T Bit</b>
BRA label	PC+4+disp×2 → PC	1010ddddddddddd	1	—

---

**Description**

This is an unconditional branch instruction. The branch destination is address (PC + 4 + displacement × 2). The PC source value is the BRA instruction address. As the 12-bit displacement is multiplied by two after sign-extension, the branch destination can be located in the range from -4096 to +4094 bytes from the BRA instruction. If the branch destination cannot be reached, this branch can be performed with a JMP instruction.

**Notes**

As this is a delayed branch instruction, the instruction following this instruction is executed before the branch destination instruction.

Interrupts are not accepted between this instruction and the following instruction. If the following instruction is a branch instruction, it is identified as a slot illegal instruction.

**Operation**

```
BRA(int d)    /* BRA disp */
{
    int disp;
    unsigned int temp;

    temp=PC;
    if ((d&0x800)==0)
        disp=(0x0000FFF & d);
    else    disp=(0xFFFFF000 | d);
    PC=PC+4+(disp<<1);
    Delay_Slot(temp+2);
}
```

### Example

```
BRA TRGET           ; Branch to TRGET.  
ADD R0 ,R1         ; ADD executed before branch.  
NOP                ;  
TRGET :            ; ← BRA instruction branch destination
```

## 10.8 BRAF BRANch Far

Unconditional Branch

## Branch Instruction

Delayed Branch Instruction

Format	Summary of Operation	Instruction Code	Execution States	T Bit
BRAF Rn	PC+4+Rn → PC	0000nnnn00100011	2	—

### Description

This is an unconditional branch instruction. The branch destination is address (PC + 4 + Rn). The branch destination address is the result of adding 4 plus the 32-bit contents of general register Rn to PC.

### Notes

As this is a delayed branch instruction, the instruction following this instruction is executed before the branch destination instruction.

Interrupts are not accepted between this instruction and the following instruction. If the following instruction is a branch instruction, it is identified as a slot illegal instruction.

### Operation

```
BRAF(int n) /* BRAF Rn */
{
    unsigned int temp;

    temp=PC;
    PC=PC+4+R[n];
    Delay_Slot(temp+2);
}
```

### Example

```
MOV.L #(TRGET-BRAF_PC),R0 ; Set displacement.
BRAF R0 ; Branch to TRGET.
ADD R0,R1 ; ADD executed before branch.
BRAF_PC: ;
NOP
TRGET: ; ← BRAF instruction branch destination
```

**10.9 BSR Branch to SubRoutine**  
Branch to Subroutine Procedure

**Branch Instruction**  
Delayed Branch Instruction

Format	Summary of Operation	Instruction Code	Execution States	T Bit
BSR label	PC+4 → PR, PC+4+disp×2 → PC	1011ddddddddddd	1	—

**Description**

This instruction branches to address (PC + 4 + displacement × 2), and stores address (PC + 4) in PR. The PC source value is the BSR instruction address. As the 12-bit displacement is multiplied by two after sign-extension, the branch destination can be located in the range from -4096 to +4094 bytes from the BSR instruction. If the branch destination cannot be reached, this branch can be performed with a JSR instruction.

**Notes**

As this is a delayed branch instruction, the instruction following this instruction is executed before the branch destination instruction.

Interrupts are not accepted between this instruction and the following instruction. If the following instruction is a branch instruction, it is identified as a slot illegal instruction.

**Operation**

```
BSR(int d) /* BSR disp */
{
    int disp;
    unsigned int temp;

    temp=PC;
    if ((d&0x800)==0)
        disp=(0x00000FFF & d);
    else disp=(0xFFFFF000 | d);
    PR=PC+4;
    PC=PC+4+(disp<<1);
    Delay_Slot(temp+2);
}
```

### Example

```
BSR  TRGET      ; Branch to TRGET.
MOV  R3 ,R4     ; MOV executed before branch.
ADD  R0 ,R1     ; Subroutine procedure return destination (contents of PR)
.....
.....
TRGET :         ; ← Entry to procedure
MOV  R2 ,R3     ;
RTS                    ; Return to above ADD instruction.
MOV  #1 ,R0     ; MOV executed before branch.
```

**10.10 BSRF**      **Branch to SubRoutine Far**  
Branch to Subroutine Procedure

**Branch Instruction**  
Delayed Branch Instruction

---

<b>Format</b>	<b>Summary of Operation</b>	<b>Instruction Code</b>	<b>Execution States</b>	<b>T Bit</b>
BSRF Rn	PC+4 → PR, PC+4+Rn → PC	0000nnnn00000011	2	—

---

**Description**

This instruction branches to address (PC + 4 + Rn), and stores address (PC + 4) in PR. The PC source value is the BSRF instruction address. The branch destination address is the result of adding the 32-bit contents of general register Rn to PC + 4.

**Notes**

As this is a delayed branch instruction, the instruction following this instruction is executed before the branch destination instruction.

Interrupts are not accepted between this instruction and the following instruction. If the following instruction is a branch instruction, it is identified as a slot illegal instruction.

**Operation**

```
BSRF(int n)      /* BSRF Rn */  
{  
    unsigned int temp;  
  
    temp=PC;  
    PR=PC+4;  
    PC=PC+4+R[n];  
    Delay_Slot(tmp+2);  
}
```

### Example

```
MOV.L  #(TRGET-BSRF_PC),R0 ; Set displacement.
BSRF   R0                   ; Branch to TRGET.
MOV    R3,R4                ; MOV executed before branch.
BSRF_PC:                    ;
ADD    R0,R1                ;
      .....
TRGET:                       ; ← Entry to procedure
MOV    R2,R3                ;
RTS    ; Return to above ADD instruction.
MOV    #1,R0                ; MOV executed before branch.
```



## 10.11 BT Branch if True

Conditional Branch

## Branch Instruction

---

Format	Summary of Operation	Instruction Code	Execution States	T Bit
BT label	If T = 1 PC + 4 + disp × 2 → PC If T = 0, nop	10001001ddddddd	1	—

---

### Description

This is a conditional branch instruction that references the T bit. The branch is taken if T = 1, and not taken if T = 0.

The branch destination is address (PC + 4 + displacement × 2). The PC source value is the BT instruction address. As the 8-bit displacement is multiplied by two after sign-extension, the branch destination can be located in the range from -256 to +254 bytes from the BT instruction.

### Notes

If the branch destination cannot be reached, the branch must be handled by using BT in combination with a BRA or JMP instruction, for example.

### Operation

```
BT(int d) /* BT disp */
{
    int disp;

    if ((d&0x80)==0)
        disp=(0x000000FF & d);
    else disp=(0xFFFFFFFF00 | d);
    if (T==1)
        PC=PC+4+(disp<<1);
    else PC+=2;
}
```

### Example

```
SETT                ; Normally T = 1
BF   TRGET_F        ; T = 1, so branch is not taken.
BT   TRGET_T        ; T = 1, so branch to TRGET_T.
NOP                ;
NOP                ;
TRGET_T:           ; ← BT instruction branch destination
```

**10.12 BT/S Branch if True with delay Slot**  
Conditional Branch with Delay

**Branch Instruction**  
Delayed Branch Instruction

---

<b>Format</b>	<b>Summary of Operation</b>	<b>Instruction Code</b>	<b>Execution States</b>	<b>T Bit</b>
BT/S label	If T = 1 PC + 4 + disp × 2 → PC If T = 0, nop	10001101ddddddd	1	—

---

**Description**

This is a conditional branch instruction that references the T bit. The branch is taken if T = 1, and not taken if T = 0.

The PC source value is the BT/S instruction address. As the 8-bit displacement is multiplied by two after sign-extension, the branch destination can be located in the range from -256 to +254 bytes from the BT/S instruction. If the branch destination cannot be reached, the branch must be handled by using BT/S in combination with a BRA or JMP instruction, for example.

**Notes**

As this is a delayed branch instruction, when the branch condition is satisfied, the instruction following this instruction is executed before the branch destination instruction.

Interrupts are not accepted between this instruction and the following instruction.

If the following instruction is a branch instruction, it is identified as a slot illegal instruction.

## Operation

```
BTS(int d)    /* BTS disp */
{
    int disp;
    unsigned temp;

    temp=PC;
    if ((d&0x80)==0)
        disp=(0x000000FF & d);
    else disp=(0xFFFFFFFF00 | d);
    if (T==1)
        PC=PC+4+(disp<<1);
    else PC+=4;
    Delay_Slot(temp+2);
}
```

## Example

```
SETT                                ;Normally T = 1
BF/S  TRGET_F                        ;T = 1, so branch is not taken.
NOP                                   ;
BT/S  TRGET_T                        ;T = 1, so branch to TRGET_T.
ADD   R0 , R1                        ;Executed before branch.
NOP                                   ;
TRGET_T:                             ;← BT/S instruction branch destination
```

## 10.13 CLRMAC Clear MAC register MAC Register Clear

## System Control Instruction

---

Format	Summary of Operation	Instruction Code	Execution States	T Bit
CLRMAC	0 → MACH, MACL	0000000000101000	1	—

---

### Description

This instruction clears the MACH and MACL registers.

### Operation

```
CLRMAC( ) /* CLRMAC */  
{  
    MACH=0;  
    MACL=0;  
    PC+=2;  
}
```

### Example

```
CLRMAC                ; Clear MAC register to initialize.  
MAC.W @R0+, @R1+     ; Multiply-and-accumulate operation  
MAC.W @R0+, @R1+     ;
```

## 10.14 CLRS S Bit Clear

### CleaR S bit

### System Control Instruction

---

Format	Summary of Operation	Instruction Code	Execution States	T Bit
CLRS	0 → S	0000000001001000	1	—

---

#### Description

This instruction clears the S bit to 0.

#### Operation

```
CLRS( ) /* CLRS */  
{  
    S=0;  
    PC+=2;  
}
```

#### Example

```
CLRS ; Before execution S = 1  
      ; After execution S = 0
```

## 10.15 CLRT      Clear T bit

T Bit Clear

## System Control Instruction

---

Format	Summary of Operation	Instruction Code	Execution States	T Bit
CLRT	0 → T	0000000000001000	1	0

---

### Description

This instruction clears the T bit.

### Operation

```
CLRT( )      /* CLRT */  
{  
    T=0;  
    PC+=2;  
}
```

### Example

```
CLRT          ; Before execution T = 1  
              ; After execution T = 0
```

## 10.16 CMP/cond CoMPare conditionally Arithmetic Instruction

Compare

---

Format		Summary of Operation	Instruction Code	Execution States	T Bit
CMP/EQ	Rm,Rn	If $R_n = R_m$ , $1 \rightarrow T$	0011nnnnmmmm0000	1	Result of comparison
CMP/GE	Rm,Rn	If $R_n \geq R_m$ , signed, $1 \rightarrow T$	0011nnnnmmmm0011	1	Result of comparison
CMP/GT	Rm,Rn	If $R_n > R_m$ , signed, $1 \rightarrow T$	0011nnnnmmmm0111	1	Result of comparison
CMP/HI	Rm,Rn	If $R_n > R_m$ , unsigned, $1 \rightarrow T$	0011nnnnmmmm0110	1	Result of comparison
CMP/HS	Rm,Rn	If $R_n \geq R_m$ , unsigned, $1 \rightarrow T$	0011nnnnmmmm0010	1	Result of comparison
CMP/PL	Rn	If $R_n > 0$ , $1 \rightarrow T$	0100nnnn00010101	1	Result of comparison
CMP/PZ	Rn	If $R_n \geq 0$ , $1 \rightarrow T$	0100nnnn00010001	1	Result of comparison
CMP/STR	Rm,Rn	If any bytes are equal, $1 \rightarrow T$	0010nnnnmmmm1100	1	Result of comparison
CMP/EQ	#imm,R0	If $R_0 = \text{imm}$ , $1 \rightarrow T$	10001000iiiiiii	1	Result of comparison

---

### Description

This instruction compares general registers  $R_n$  and  $R_m$ , and sets the T bit if the specified condition (cond) is true. If the condition is false, the T bit is cleared. The contents of  $R_n$  are not changed. Nine conditions can be specified. For the two conditions PZ and PL,  $R_n$  is compared with 0.

With the EQ condition, sign-extended 8-bit immediate data can be compared with  $R_0$ . The contents of  $R_0$  are not changed.



<b>Mnemonic</b>		<b>Description</b>
CMP/EQ	Rm,Rn	If Rn = Rm, T = 1
CMP/GE	Rm,Rn	If Rn ≥ Rm as signed values, T = 1
CMP/GT	Rm,Rn	If Rn > Rm as signed values, T = 1
CMP/HI	Rm,Rn	If Rn > Rm as unsigned values, T = 1
CMP/HS	Rm,Rn	If Rn ≥ Rm as unsigned values, T = 1
CMP/PL	Rn	If Rn > 0, T = 1
CMP/PZ	Rn	If Rn ≥ 0, T = 1
CMP/STR	Rm,Rn	If any bytes are equal, T = 1
CMP/EQ	#imm,R0	If R0 = imm, T = 1

### Operation

```

CMPEQ(long m, long n)    /* CMP_EQ Rm,Rn */
{
    if (R[n]==R[m]) T=1;
    else T=0;
    PC+=2;
}

CMPGE(long m, long n)    /* CMP_GE Rm,Rn */
{
    if ((long)R[n]>=(long)R[m]) T=1;
    else T=0;
    PC+=2;
}

CMPGT(long m, long n)    /* CMP_GT Rm,Rn */
{
    if ((long)R[n]>(long)R[m]) T=1;
    else T=0;
    PC+=2;
}

CMPHI(long m, long n)    /* CMP_HI Rm,Rn */
{
    if ((unsigned long)R[n]>(unsigned long)R[m]) T=1;
    else T=0;
}

```

```

    PC+=2;
}

CMPHS(long m, long n)    /* CMP_HS Rm,Rn */
{
    if ((unsigned long)R[n]>=(unsigned long)R[m]) T=1;
    else T=0;
    PC+=2;
}

CMPPL(long n)           /* CMP_PL Rn */
{
    if ((long)R[n]>0) T=1;
    else T=0;
    PC+=2;
}

CMPPPZ(long n)         /* CMP_PZ Rn */
{
    if ((long)R[n]>=0) T=1;
    else T=0;
    PC+=2;
}

CMPSTR(long m, long n) /* CMP_STR Rm,Rn */
{
    unsigned long temp;
    long HH,HL,LH,LL;

    temp=R[n]^R[m];
    HH=(temp&0xFF000000)>>24;
    HL=(temp&0x00FF0000)>>16;
    LH=(temp&0x0000FF00)>>8;
    LL=temp&0x000000FF;
    HH=HH&&HL&&LH&&LL;
    if (HH==0) T=1;
    else T=0;
}

```

```

    PC+=2;
}

CMPIM(long i)    /* CMP_EQ #imm,R0 */
{
    long imm;

    if ((i&0x80)==0) imm=(0x000000FF & (long i));
    else imm=(0xFFFFFFFF0 | (long i));
    if (R[0]==imm) T=1;
    else T=0;
    PC+=2;
}

```

### Example

CMP/GE	R0,R1	;R0 = H'7FFFFFFF, R1 = H'80000000
BT	TRGET_T	;T = 0, so branch is not taken.
CMP/HS	R0,R1	;R0 = H'7FFFFFFF, R1 = H'80000000
BT	TRGET_T	;T = 1, so branch is taken.
CMP/STR	R2,R3	;R2 = "ABCD", R3 = "XYZC"
BT	TRGET_T	;T = 1, so branch is taken.

**10.17 DIV0S      DIVide (step 0) as Signed      Arithmetic Instruction**  
 Initialization for  
 Signed Division

---

<b>Format</b>	<b>Summary of Operation</b>	<b>Instruction Code</b>	<b>Execution States</b>	<b>T Bit</b>
DIV0S Rm,Rn	MSB of Rn → Q, MSB of Rm → M, M^Q → T	0010nnnnnnmmmm0111	1	Result of calculation

---

**Description**

This instruction performs initial settings for signed division. This instruction is followed by a DIV1 instruction that executes 1-digit division, for example, and repeated divisions are executed to find the quotient. See the description of the DIV1 instruction for details.

**Operation**

```

DIV0S(long m, long n)      /* DIV0S Rm,Rn */
{
    if ((R[n] & 0x80000000)==0) Q=0;
    else Q=1;
    if ((R[m] & 0x80000000)==0) M=0;
    else M=1;
    T=(M==Q);
    PC+=2;
}
  
```

**Example**

See the examples for the DIV1 instruction.

## 10.18 DIV0U      DIVide (step 0) as Unsigned      Arithmetic Instruction

Initialization for Unsigned Division

---

Format	Summary of Operation	Instruction Code	Execution States	T Bit
DIV0U	0 → M/Q/T	0000000000011001	1	0

### Description

This instruction performs initial settings for unsigned division. This instruction is followed by a DIV1 instruction that executes 1-digit division, for example, and repeated divisions are executed to find the quotient. See the description of the DIV1 instruction for details.

### Operation

```

DIV0U( )            /* DIV0U */
{
    M=Q=T=0;
    PC+=2;
}

```

### Example

See the examples for the DIV1 instruction.

## 10.19 DIV1 Division

### DIVide 1 step

### Arithmetic Instruction

Format	Summary of Operation	Instruction Code	Execution States	T Bit
DIV1 Rm,Rn	1-step division (Rn ÷ Rm)	0011nnnnmmmm0100	1	Result of calculation

#### Description

This instruction performs 1-digit division (1-step division) of the 32-bit contents of general register Rn (dividend) by the contents of Rm (divisor). The quotient is obtained by repeated execution of this instruction alone or in combination with other instructions. The specified registers and the M, Q, and T bits must not be modified during these repeated executions.

In 1-step division, the dividend is shifted 1 bit to the left, the divisor is subtracted from this, and the quotient bit is reflected in the Q bit according to whether the result is positive or negative.

The remainder can be found as follows after first finding the quotient using the DIV1 instruction:

$$(\text{Remainder}) = (\text{dividend}) - (\text{divisor}) \times (\text{quotient})$$

Detection of division by zero or overflow is not provided. Check for division by zero and overflow division before executing the division. A remainder operation is not provided. Find the remainder by finding the product of the divisor and the obtained quotient, and subtracting this value from the dividend.

Initial settings should first be made with the DIV0S or DIV0U instruction. DIV1 is executed once for each bit of the divisor. If a quotient of more than 17 bits is required, place an ROTCL instruction before the DIV1 instruction. See the examples for details of the division sequence.

#### Operation

```
DIV1(long m, long n)    /* DIV1 Rm,Rn */
{
    unsigned long tmp0, tmp2;
    unsigned char old_q, tmp1;

    old_q=Q;
    Q=(unsigned char)((0x80000000 & R[n])!=0);
    tmp2= R[m];
    R[n]<<=1;
    R[n]|=(unsigned long)T;
```

Rev. 3.0, 09/99, page 231 of 396

```

switch(old_q){
case 0:switch(M){
    case 0:tmp0=R[n];
        R[n]-=tmp2;
        tmp1=(R[n]>tmp0);
        switch(Q){
        case 0:Q=tmp1;
            break;
        case 1:Q=(unsigned char)(tmp1==0);
            break;
        }
        break;
    case 1:tmp0=R[n];
        R[n]+=tmp2;
        tmp1=(R[n]<tmp0);
        switch(Q){
        case 0:Q=(unsigned char)(tmp1==0);
            break;
        case 1:Q=tmp1;
            break;
        }
        break;
    }
    break;
case 1:switch(M){
    case 0:tmp0=R[n];
        R[n]+=tmp2;
        tmp1=(R[n]<tmp0);
        switch(Q){
        case 0:Q=tmp1;
            break;
        case 1:Q=(unsigned char)(tmp1==0);
            break;
        }
        break;
    case 1:tmp0=R[n];

```

```

R[n]-=tmp2;
tmp1=(R[n]>tmp0);
switch(Q){
case 0:Q=(unsigned char)(tmp1==0);
        break;
case 1:Q=tmp1;
        break;
}
break;
}
break;
}
T=(Q==M);
PC+=2;
}

```

### Example 1

```

;R1 (32 bits) ÷ R0 (16 bits) = R1 (16 bits); unsigned
SHLL16    R0                ;Set divisor in upper 16 bits, clear lower 16 bits to 0
TST      R0,R0              ;Check for division by zero
BT       ZERO_DIV           ;
CMP/HS   R0,R1              ;Check for overflow
BT       OVER_DIV           ;
DIV0U    ;Flag initialization
.repeat  16                 ;
DIV1     R0,R1              ;Repeat 16 times
.aendr   ;
ROTCL    R1                  ;
EXTU.W   R1,R1              ;R1 = quotient

```



## Example 2

```

; R1:R2 (64 bits) ÷ R0 (32 bits) = R2 (32 bits); unsigned
TST      R0,R0      ; Check for division by zero
BT       ZERO_DIV   ;
CMP/HS   R0,R1      ; Check for overflow
BT       OVER_DIV   ;
DIV0U    ; Flag initialization
. arepeat 32        ;
ROTCL    R2          ; Repeat 32 times
DIV1     R0,R1      ;
. aendr   ;
ROTCL    R2          ; R2 = quotient
```

## Example 3

```

; R1 (16 bits) ÷ R0 (16 bits) = R1 (16 bits); signed
SHLL16   R0          ; Set divisor in upper 16 bits, clear lower 16 bits to 0
EXTS.W   R1,R1       ; Dividend sign-extended to 32 bits
XOR      R2,R2       ; R2 = 0
MOV      R1,R3       ;
ROTCL    R3          ;
SUBC     R2,R1       ; If dividend is negative, subtract 1
DIV0S    R0,R1       ; Flag initialization
. arepeat 16        ;
DIV1     R0,R1       ; Repeat 16 times
. aendr   ;
EXTS.W   R1,R1       ;
ROTCL    R1          ; R1 = quotient (one's complement notation)
ADDC     R2,R1       ; If MSB of quotient is 1, add 1 to convert to two's complement notation
EXTS.W   R1,R1       ; R1 = quotient (two's complement notation)
```

#### Example 4

```
                                ; R2 (32 bits) ÷ R0 (32 bits) = R2 (32 bits); signed
MOV      R2 ,R3                ;
ROTCL    R3                    ;
SUBC     R1 ,R1                ; Dividend sign-extended to 64 bits (R1:R2)
XOR      R3 ,R3                ; R3 = 0
SUBC     R3 ,R2                ; If dividend is negative, subtract 1 to convert to one's complement notation
DIV0S    R0 ,R1                ; Flag initialization
.repeat  32                    ;
ROTCL    R2                    ; Repeat 32 times
DIV1     R0 ,R1                ;
.aendr                                     ;
ROTCL    R2                    ; R2 = quotient (one's complement notation)
ADDC     R3 ,R2                ; If MSB of quotient is 1, add 1 to convert to two's complement notation
                                ; R2 = quotient (two's complement notation)
```

**10.20 DMULS.L**      **Double-length**  
**MULTiPLY as Signed**      **Arithmetic Instruction**  
Signed Double-Length  
Multiplication

---

Format	Summary of Operation	Instruction Code	Execution States	T Bit
DMULS.L Rm,Rn	Signed, Rn × Rm → MACH, MACL	0011nnnnmmmm1101	2-5	—

---

**Description**

This instruction performs 32-bit multiplication of the contents of general register Rn by the contents of Rm, and stores the 64-bit result in the MACH and MACL registers. The multiplication is performed as a signed arithmetic operation.

**Operation**

```
DMULS(long m, long n) /* DMULS.L Rm,Rn */
{
    unsigned long RnL,RnH,RmL,RmH,Res0,Res1,Res2;
    unsigned long temp0,temp1,temp2,temp3;
    long tempm,tempn,fnLmL;

    tempn=(long)R[n];
    tempm=(long)R[m];
    if (tempn<0) tempn=0-tempn;
    if (tempm<0) tempm=0-tempm;
    if ((long)(R[n]^R[m])<0) fnLmL=-1;
    else fnLmL=0;

    temp1=(unsigned long)tempn;
    temp2=(unsigned long)tempm;

    RnL=temp1&0x0000FFFF;
    RnH=(temp1>>16)&0x0000FFFF;
    RmL=temp2&0x0000FFFF;
    RmH=(temp2>>16)&0x0000FFFF;
```

```

temp0=RmL*RnL;
temp1=RmH*RnL;
temp2=RmL*RnH;
temp3=RmH*RnH;

Res2=0;
Res1=temp1+temp2;
if (Res1<temp1) Res2+=0x00010000;
temp1=(Res1<<16)&0xFFFF0000;
Res0=temp0+temp1;
if (Res0<temp0) Res2++;

Res2=Res2+((Res1>>16)&0x0000FFFF)+temp3;

if (fnLmL<0) {
    Res2=~Res2;
    if (Res0==0)
        Res2++;
    else
        Res0=(~Res0)+1;
}

MACH=Res2;
MACL=Res0;
PC+=2;
}

```

### Example

DMULS.L	R0,R1	; Before execution R0 = H'FFFFFFFE, R1 = H'00005555
		; After execution MACH = H'FFFFFFF, MACL = H'FFFF5556
STS	MACH,R0	; Get operation result (upper)
STS	MACL,R1	; et operation result (lower)

## 10.21 DMULU.L Double-length MULTiply as Unsigned

## Arithmetic Instruction

Unsigned Double-Length  
Multiplication

Format	Summary of Operation	Instruction Code	Execution States	T Bit
DMULU.L Rm,Rn	Unsigned, Rn × Rm → MACH, MACL	0011nnnnmmmm0101	2–5	—

### Description

This instruction performs 32-bit multiplication of the contents of general register Rn by the contents of Rm, and stores the 64-bit result in the MACH and MACL registers. The multiplication is performed as an unsigned arithmetic operation.

### Operation

```
DMULU(long m, long n) /* DMULU.L Rm,Rn */
{
    unsigned long RnL,RnH,RmL,RmH,Res0,Res1,Res2;
    unsigned long temp0,temp1,temp2,temp3;

    RnL=R[n]&0x0000FFFF;
    RnH=(R[n]>>16)&0x0000FFFF;

    RmL=R[m]&0x0000FFFF;
    RmH=(R[m]>>16)&0x0000FFFF;

    temp0=RmL*RnL;
    temp1=RmH*RnL;
    temp2=RmL*RnH;
    temp3=RmH*RnH;

    Res2=0
    Res1=temp1+temp2;
    if (Res1<temp1) Res2+=0x00010000;

    temp1=(Res1<<16)&0xFFFF0000;
```

```

Res0=temp0+temp1;
if (Res0<temp0) Res2++;

Res2=Res2+((Res1>>16)&0x0000FFFF)+temp3;

MACH=Res2;
MACL=Res0;
PC+=2;
}

```

### Example

DMULU.L	R0,R1	; Before execution R0 = H'FFFFFFFE, R1 = H'00005555
		; After execution MACH = H'00005554, MACL = H'FFFF5556
STS	MACH,R0	; Get operation result (upper)
STS	MACL,R1	; Get operation result (lower)

**10.22 DT Decrement and Test**  
Decrement and Test

**Arithmetic Instruction**

Format	Summary of Operation	Instruction Code	Execution States	T Bit
DT Rn	Rn - 1 → Rn; if Rn = 0, 1 → T if Rn ≠ 0, 0 → T	0100nnnn00010000	1	Test result

**Description**

This instruction decrements the contents of general register Rn by 1 and compares the result with zero. If the result is zero, the T bit is set to 1. If the result is nonzero, the T bit is cleared to 0.

**Operation**

```
DT(long n)/* DT Rn */
{
    R[n]--;
    if (R[n]==0) T=1;
    else T=0;
    PC+=2;
}
```

**Example**

```
MOV    #4,R5    ; Set loop count
LOOP:
ADD    R0,R1    ;
DT     R5       ; Decrement R5 value and check for 0.
BF     LOOP     ; If T = 0, branch to LOOP (in this example, 4 loops are executed).
```

## 10.23 EXTS      EXTend as Signed

Sign Extension

## Arithmetic Instruction

Format	Summary of Operation	Instruction Code	Execution States	T Bit
EXTS.B Rm,Rn	Rm sign-extended from byte → Rn	0110nnnnmmmm1110	1	—
EXTS.W Rm,Rn	Rm sign-extended from word → Rn	0110nnnnmmmm1111	1	—

### Description

This instruction sign-extends the contents of general register Rm and stores the result in Rn.

For a byte specification, the value of Rm bit 7 is transferred to Rn bits 8 to 31. For a word specification, the value of Rm bit 15 is transferred to Rn bits 16 to 31.

### Operation

```
EXTSB(long m, long n) /* EXTS.B Rm,Rn */
{
    R[n]=R[m];
    if ((R[m]&0x00000080)==0) R[n]&=0x000000FF;
    else R[n]|=0xFFFFFFFF00;
    PC+=2;
}

EXTSW(long m, long n) /* EXTS.W Rm,Rn */
{
    R[n]=R[m];
    if ((R[m]&0x00008000)==0) R[n]&=0x0000FFFF;
    else R[n]|=0xFFFF0000;
    PC+=2;
}
```



### Example

```
EXTS.B R0,R1      ; Before execution R0 = H'00000080
                   ; After execution   R1 = H'FFFFFF80
EXTS.W R0,R1      ; Before execution R0 = H'00008000
                   ; After execution   R1 = H'FFFF8000
```

## Zero Extension

---

Format	Summary of Operation	Instruction Code	Execution States	T Bit
EXTU.B Rm,Rn	Rm zero-extended from byte → Rn	0110nnnnmmmm1100	1	—
EXTU.W Rm,Rn	Rm zero-extended from word → Rn	0110nnnnmmmm1101	1	—

---

### Description

This instruction zero-extends the contents of general register Rm and stores the result in Rn.

For a byte specification, 0 is transferred to Rn bits 8 to 31. For a word specification, 0 is transferred to Rn bits 16 to 31.

### Operation

```
EXTUB(long m, long n) /* EXTU.B Rm,Rn */
{
    R[n]=R[m];
    R[n]&=0x000000FF;
    PC+=2;
}

EXTUW(long m, long n) /* EXTU.W Rm,Rn */
{
    R[n]=R[m];
    R[n]&=0x0000FFFF;
    PC+=2;
}
```

### Example

```
EXTU.B R0,R1      ; Before execution R0 = H'FFFFFF80
                  ; After execution  R1 = H'00000080

EXTU.W R0,R1      ; Before execution R0 = H'FFFF8000
                  ; After execution  R1 = H'00008000
```

## 10.25 FABS Floating-point ABSolute value Floating-Point Instruction

Floating-Point  
Absolute Value

---

PR	Format	Summary of Operation	Instruction Code	Execution States	T Bit
0	FABS FRn	FRn  → FRn	1111n00001011101	1	—
1	FABS DRn	DRn  → DRn	1111n000001011101	1	—

### Description

This instruction clears the most significant bit of the contents of floating-point register FRn/DRn to 0, and stores the result in FRn/DRn.

The cause and flag fields in FPSCR are not updated.

### Operation

```
void FABS (int n){
    FR[n] = FR[n] & 0x7fffffff;
    pc += 2;
}
/* Same operation is performed regardless of precision. */
```

### Possible Exceptions:

None

**10.26 FADD Floating-point ADD Floating-Point Instruction**  
 Floating-Point Addition

PR	Format	Summary of Operation	Instruction Code	Execution States	T Bit
0	FADD FRm,FRn	FRn+FRm → FRn	1111nnnnmmmm0000	1	—
1	FADD DRm,DRn	DRn+DRm → DRn	1111nnn0mmm00000	6	—

**Description**

When FPSCR.PR = 0: Arithmetically adds the two single-precision floating-point numbers in FRn and FRm, and stores the result in FRn.

When FPSCR.PR = 1: Arithmetically adds the two double-precision floating-point numbers in DRn and DRm, and stores the result in DRn.

When FPSCR.enable.O/U/I is set, an FPU exception trap is generated regardless of whether or not an exception has occurred. When an exception occurs, correct exception information is reflected in FPSCR.cause and FPSCR.flag, and FRn or DRn is not updated. Appropriate processing should therefore be performed by software.

**Operation**

```
void FADD (int m,n)
{
    pc += 2;
    clear_cause();
    if((data_type_of(m) == sNaN) ||
        (data_type_of(n) == sNaN)) invalid(n);
    else if((data_type_of(m) == qNaN) ||
        (data_type_of(n) == qNaN)) qnan(n);
    else if((data_type_of(m) == DENORM) ||
        (data_type_of(n) == DENORM)) set_E();
    else switch (data_type_of(m)){
        case NORM: switch (data_type_of(n)){
            case NORM:    normal_faddsub(m,n,ADD); break;
            case PZERO:
            case NZERO:register_copy(m,n); break;
            default:      break;
        }
        break;
    }
}
```

```

    case PZERO: switch (data_type_of(n)){
        case NZERO:  zero(n,0); break;
        default:    break;
    }          break;
    case NZERO:    break;
    case PINF: switch (data_type_of(n)){
        case NINF:  invalid(n);  break;
        default:   inf(n,0);     break;
    }          break;
    case NINF: switch (data_type_of(n)){
        case PINF:  invalid(n);  break;
        default:   inf(n,1);     break;
    }          break;
}
}
}

```

### FADD Special Cases

FRm,DRm	FRn,DRn							
	NORM	+0	-0	+INF	-INF	DENORM	qNaN	sNaN
NORM	ADD				-INF			
+0		+0						
-0			-0					
+INF				+INF	Invalid	Error		
-INF	-INF			Invalid	-INF			
DENORM								
qNaN							qNaN	Invalid
sNaN								

Note: When DN = 1, the value of a denormalized number is treated as 0.

### Possible Exceptions:

- FPU error
- Invalid operation
- Overflow
- Underflow
- Inexact

## 10.27 FCMP Floating-point CoMPare Floating-Point Instruction

Floating-Point Comparison

PR	Format	Summary of Operation	Instruction Code	Execution	
				States	T Bit
0	1. FCMP/EQ FRm,FRn	(FRn==FRm)?1:0 → T	1111nnnnmmmm0100	1	1/0
1	2. FCMP/EQ DRm,DRn	(DRn==DRm)?1:0 → T	1111nnn0mmm00100	1	1/0
0	3. FCMP/GT FRm,FRn	(FRn>FRm)?1:0 → T	1111nnnnmmmm0101	2	1/0
1	4. FCMP/GT DRm,DRn	(DRn>DRm)?1:0 → T	1111nnn0mmm00101	2	1/0

### Description

1. When FPSCR.PR = 0: Arithmetically compares the two single-precision floating-point numbers in FRn and FRm, and stores 1 in the T bit if they are equal, or 0 otherwise.
2. When FPSCR.PR = 1: Arithmetically compares the two double-precision floating-point numbers in DRn and DRm, and stores 1 in the T bit if they are equal, or 0 otherwise.
3. When FPSCR.PR = 0: Arithmetically compares the two single-precision floating-point numbers in FRn and FRm, and stores 1 in the T bit if FRn > FRm, or 0 otherwise.
4. When FPSCR.PR = 1: Arithmetically compares the two double-precision floating-point numbers in DRn and DRm, and stores 1 in the T bit if DRn > DRm, or 0 otherwise.

### Operation

```
void FCMP_EQ(int m,n) /* FCMP/EQ  FRm,FRn */
{
    pc += 2;
    clear_cause();
    if(fcmp_chk (m,n) == INVALID) fcmp_invalid();
    else if(fcmp_chk (m,n) == EQ)  T = 1;
    else                          T = 0;
}

void FCMP_GT(int m,n) /* FCMP/GT  FRm,FRn */
{
    pc += 2;
    clear_cause();
    if ((fcmp_chk (m,n) == INVALID) ||
        (fcmp_chk (m,n) == UO)) fcmp_invalid();
    else if(fcmp_chk (m,n) == GT) T = 1;
}
```

```

        else
            T = 0;
    }
int fcmp_chk (int m,n)
{
    if((data_type_of(m) == sNaN) ||
        (data_type_of(n) == sNaN)) return(INVALID);
    else if((data_type_of(m) == qNaN) ||
        (data_type_of(n) == qNaN)) return(UO);
    else switch(data_type_of(m)){
        case NORM:    switch(data_type_of(n)){
            case PINF :return(GT); break;
            case NINF :return(LT); break;
            default:    break;
        } break;
        case PZERO:
        case NZERO:   switch(data_type_of(n)){
            case PZERO :
            case NZERO :return(EQ); break;
            default:    break;
        } break;
        case PINF :   switch(data_type_of(n)){
            case PINF :return(EQ); break;
            default:return(LT);    break;
        } break;
        case NINF :   switch(data_type_of(n)){
            case NINF :return(EQ); break;
            default:return(GT);    break;
        } break;
    }
    if(FPSCR_PR == 0) {
        if(FR[n] == FR[m]) return(EQ);
        else if(FR[n] > FR[m]) return(GT);
        else return(LT);
    }else {
        if(DR[n>>1] == DR[m>>1]) return(EQ);
        else if(DR[n>>1] > DR[m>>1]) return(GT);
    }
}

```

```

        else
            return(LT);
    }
}
void fcmp_invalid()
{
    set_V();    if((FPSCR & ENABLE_V) == 0) T = 0;
               else fpu_exception_trap();
}

```

**FCMP Special Cases**

FCMP/EQ	FRn,DRn							
FRm,DRm	NORM	DNORM	+0	-0	+INF	-INF	qNaN	sNaN
NORM	CMP							Invalid
DNORM								
+0	EQ							
-0								
+INF					EQ			
-INF					EQ			
qNaN							!EQ	
sNaN								

Note: When DN = 1, the value of a denormalized number is treated as 0.

FCMP/GT	FRn,DRn								
FRm,DRm	NORM	DENORM	+0	-0	+INF	-INF	qNaN	sNaN	
NORM	CMP				GT	!GT	Invalid		
DENORM									
+0	!GT								
-0									
+INF	!GT				!GT				
-INF	GT				!GT				
qNaN									UO
sNaN									

Note: When DN = 1, the value of a denormalized number is treated as 0.

UO means unordered. Unordered is treated as false (!GT).

**Possible Exceptions:**

Invalid operation



## 10.28 FCNVDS Floating-point CoNVert Double to Single precision Floating-Point Instruction

Double-Precision  
to Single-Precision  
Conversion

PR	Format	Summary of Operation	Instruction Code	Execution States	T Bit
0	—	—	—	—	—
1	FCNVDS DRm,FPUL	(float)DRm → FPUL	1111mmm010111101	2	—

### Description

When FPSCR.PR = 1: This instruction converts the double-precision floating-point number in DRm to a single-precision floating-point number, and stores the result in FPUL.

When FPSCR.enable.O/U/I is set, an FPU exception trap is generated regardless of whether or not an exception has occurred. When an exception occurs, correct exception information is reflected in FPSCR.cause and FPSCR.flag, and FPUL is not updated. Appropriate processing should therefore be performed by software.

### Operation

```
void FCNVDS(int m, float *FPUL){
    case((FPSCR.PR){
        0: undefined_operation(); /* reserved */
        1: fcnvds(m, *FPUL); break; /* FCNVDS */
    }
}

void fcnvds(int m, float *FPUL)
{
    pc += 2;
    clear_cause();
    case(data_type_of(m, *FPUL)){
        NORM :
        PZERO :
        NZERO : normal_ fcnvds(m, *FPUL); break;
        DENORM : set_E();
        PINF : *FPUL = 0x7f800000; break;
        NINF : *FPUL = 0xff800000; break;
    }
}
```

```

        qNaN :    *FPUL = 0x7fbfffff; break;
        sNaN :    set_V();
                    if((FPSCR & ENABLE_V) == 0) *FPUL = 0x7fbfffff;
                    else fpu_exception_trap(); break;
    }
}
void normal_fcnvds(int m, float *FPUL)
{
    int sign;
    float abs;
    union {
        float f;
        int l;
    } dstf,tmpf;
    union {
        double d;
        int l[2];
    } dstd;
    dstd.d = DR[m>>1];
    if(dstd.l[1] & 0x1fffffff) set_I();
    if(FPSCR_RM == 1) dstd.l[1] &= 0xe0000000; /* round toward zero*/
    dstf.f = dstd.d;
    check_single_exception(FPUL, dstf.f);
}

```

### FCNVDS Special Cases

FRn	+NORM	-NORM	+0	-0	+INF	-INF	qNaN	sNaN
FCNVDS(FRn FPUL)	FCNVDS	FCNVDS	+0	-0	+INF	-INF	qNaN	Invalid

Note: When DN = 1, the value of a denormalized number is treated as 0.

### Possible Exceptions:

- FPU error
- Invalid operation
- Overflow
- Underflow
- Inexact

## 10.29 FCNVSD Floating-point CoNVert Single to Double precision Floating-Point Instruction

Single-Precision  
to Double-Precision  
Conversion

PR	Format	Summary of Operation	Instruction Code	Execution States	T Bit
0	—	—	—	—	—
1	FCNVSD FPUL, DRn	(double) FPUL → DRn	1111nnn010101101	2	—

### Description

When FPSCR.PR = 1: This instruction converts the single-precision floating-point number in FPUL to a double-precision floating-point number, and stores the result in DRn.

### Operation

```
void FCNVSD(int n, float *FPUL){
    pc += 2;
    clear_cause();
    case((FPSCR_PR){
        0: undefined_operation(); /* reserved */
        1: fcnvsd (n, *FPUL); break; /* FCNVSD */
    })
}

void fcnvsd(int n, float *FPUL)
{
    case(fpul_type(FPUL)){
        PZERO :
        NZERO :
        PINF  :
        NINF  :      DR[n>>1] = *FPUL;      break;
        DENORM : set_E();          break;
        qNaN  :      qnan(n);          break;
        sNaN  :      invalid(n);       break;
    }
}

int fpul_type(int *FPUL)
```

```

{
int abs;
    abs = *FPUL & 0x7fffffff;
    if(abs < 0x00800000){
        if((FPSCR_DN == 1) || (abs == 0x00000000)){
            if(sign_of(src) == 0) return(PZERO);
            else return(NZERO);
        }
        else return(DENORM);
    }
    else if(abs < 0x7f800000) return(NORM);
    else if(abs == 0x7f800000) {
        if(sign_of(src) == 0) return(PINF);
        else return(NINF);
    }
    else if(abs < 0x7fc00000) return(qNaN);
    else return(sNaN);
}

```

#### FCNVSD Special Cases

FRn	+NORM	-NORM	+0	-0	+INF	-INF	qNaN	sNaN
FCNVSD(FPUL FRn)	+NORM	-NORM	+0	-0	+INF	-INF	qNaN	Invalid

Note: When DN = 1, the value of a denormalized number is treated as 0.

#### Possible Exceptions:

- FPU error
- Invalid operation

**10.30 FDIV Floating-point DIVide Floating-Point Instruction**  
 Floating-Point  
 Division

PR	Format	Summary of Operation	Instruction Code	Execution States	T Bit
0	FDIV FRm,FRn	FRn/FRm → FRn	1111nnnnmmmm0011	10	—
1	FDIV DRm,DRn	DRn/DRm → DRn	1111nnn0mmm00011	23	—

**Description**

When FPSCR.PR = 0: Arithmetically divides the single-precision floating-point number in FRn by the single-precision floating-point number in FRm, and stores the result in FRn.

When FPSCR.PR = 1: Arithmetically divides the double-precision floating-point number in DRn by the double-precision floating-point number in DRm, and stores the result in DRn.

When FPSCR.enable.O/U/I is set, an FPU exception trap is generated regardless of whether or not an exception has occurred. When an exception occurs, correct exception information is reflected in FPSCR.cause and FPSCR.flag, and FRn or DRn is not updated. Appropriate processing should therefore be performed by software.

**Operation**

```
void FDIV(int m,n) /* FDIV FRm,FRn */
{
    pc += 2;
    clear_cause();
    if((data_type_of(m) == sNaN) ||
        (data_type_of(n) == sNaN)) invalid(n);
    else if((data_type_of(m) == qNaN) ||
        (data_type_of(n) == qNaN)) qnan(n);
    else switch (data_type_of(m)){
        case NORM: switch (data_type_of(n)){
            case PINF:
            case NINF: inf(n,sign_of(m)^sign_of(n));break;
            case PZERO:
            case NZERO: zero(n,sign_of(m)^sign_of(n));break;
            case DENORM:set_E(); break;
            default: normal_fdiv(m,n); break;
        } break;
    }
```

```

        case PZERO: switch (data_type_of(n)){
            case PZERO:
            case NZERO: invalid(n);break;
            case PINF:
            case NINF: break;
            default: dz(n,sign_of(m)^sign_of(n));break;
        } break;
    case NZERO: switch (data_type_of(n)){
        case PZERO:
        case NZERO: invalid(n); break;
        case PINF: inf(n,1); break;
        case NINF: inf(n,0); break;
        default: dz(FR[n],sign_of(m)^sign_of(n)); break;
    } break;
    case DENORM: set_E(); break;
    case PINF :
    case NINF : switch (data_type_of(n)){
        case DENORM: set_E(); break;
        case PINF:
        case NINF: invalid(n); break;
        default: zero(n,sign_of(m)^sign_of(n));break
    } break;
    }
}
void normal_fdiv(int m,n)
{
    union {
        float f;
        int l;
    } dstf,tmpf;
    union {
        double d;
        int l[2];
    } dstd,tmpd;
    union {
        int double x;
        int l[4];
    }

```

```

    }    tmpx;
    if(FPSCR_PR == 0) {
        tmpf.f = FR[n]; /* save destination value */
        dstf.f /= FR[m]; /* round toward nearest or even */
        tmpd.d = dstf.f; /* convert single to double */
        tmpd.d *= FR[m];
        if(tmpf.f != tmpd.d) set_I();
        if((tmpf.f < tmpd.d) && (SPSCR_RM == 1))
            dstf.l -= 1; /* round toward zero */
        check_single_exception(&FR[n], dstf.f);
    } else {
        tmpd.d = DR[n>>1]; /* save destination value */
        dstd.d /= DR[m>>1]; /* round toward nearest or even */
        tmpx.x = dstd.d; /* convert double to int double */
        tmpx.x *= DR[m>>1];
        if(tmpd.d != tmpx.x) set_I();
        if((tmpd.d < tmpx.x) && (SPSCR_RM == 1)) {
            dstd.l[1] -= 1; /* round toward zero */
            if(dstd.l[1] == 0xffffffff) dstd.l[0] -= 1;
        }
        check_double_exception(&DR[n>>1], dstd.d);
    }
}
}

```

### FDIV Special Cases

FRm,DRm	FRn,DRn							
	NORM	+0	-0	+INF	-INF	DENORM	qNaN	sNaN
NORM	DIV	0		INF		Error	qNaN	Invalid
+0	DZ	Invalid		+INF	-INF	DZ		
-0				-INF	+INF			
+INF	0	+0	-0	Invalid		Error		
-INF		-0	+0					
DENORM	Error							
qNaN								
sNaN								Invalid

Note: When DN = 1, the value of a denormalized number is treated as 0.

**Possible Exceptions:**

- FPU error
- Invalid operation
- Divide by zero
- Overflow
- Underflow
- Inexact



## 10.31 FIPR

## Floating-point Inner Product

## Floating-Point Instruction

Floating-Point  
Inner Product

PR	Format	Summary of Operation	Instruction Code	Execution States	T Bit
0	FIPR FV <sub>m</sub> ,FV <sub>n</sub>	FV <sub>n</sub> · FV <sub>m</sub> → FR[n+3]	1111nnmm11101101	1	—
—	—	—	—	—	—

Notes: FV0 = {FR0, FR1, FR2, FR3}  
FV4 = {FR4, FR5, FR6, FR7}  
FV8 = {FR8, FR9, FR10, FR11}  
FV12 = {FR12, FR13, FR14, FR15}

### Description

When FPSCR.PR = 0: This instruction calculates the inner products of the 4-dimensional single-precision floating-point vector indicated by FV<sub>n</sub> and FV<sub>m</sub>, and stores the results in FR[n + 3].

The FIPR instruction is intended for speed rather than accuracy, and therefore the results will differ from those obtained by using a combination of FADD and FMUL instructions. The FIPR execution sequence is as follows:

1. Multiplies all terms. The results are 28 bits long.
2. Aligns these results, rounding them to fit within 30 bits.
3. Adds the aligned values.
4. Performs normalization and rounding.

Special processing is performed in the following cases:

1. If an input value is an sNaN, an invalid exception is generated.
2. If the input values to be multiplied include a combination of 0 and infinity, an invalid exception is generated.
3. In cases other than the above, if the input values include a qNaN, the result will be a qNaN.
4. In cases other than the above, if the input values include infinity:
  - a. If multiplication results in two or more infinities and the signs are different, an invalid exception will be generated.
  - b. Otherwise, correct infinities will be stored.
5. If the input values do not include an sNaN, qNaN, or infinity, processing is performed in the normal way.

When FPSCR.enable.O/U/I is set, an FPU exception trap is generated regardless of whether or not an exception has occurred. When an exception occurs, correct exception information is reflected in FPSCR.cause and FPSCR.flag, and FRn or DRn is not updated. Appropriate processing should therefore be performed by software.

### Operation

```
void FIPR(int m,n) /* FIPR FVm,FVn */
{
    if(FPSCR_PR == 0) {
        pc += 2;
        clear_cause();
        fipr(m,n);
    }
    else    undefined_operation();
}
```

### Possible Exceptions:

- Invalid operation
- Overflow
- Underflow
- Inexact

**10.32 FLDI0 Floating-point Load Immediate 0.0 Floating-Point Instruction**  
 0.0 Load

PR	Format	Summary of Operation	Instruction Code	Execution States	T Bit
0	FLDI0 FRn	0x00000000 → FRn	1111nnnn10001101	1	—
1	—	—	—	—	—

**Description**

When FPSCR.PR = 0, this instruction loads floating-point 0.0 (0x00000000) into FRn.

**Operation**

```
void FLDI0(int n)
{
    FR[n] = 0x00000000;
    pc += 2;
}
```

**Possible Exceptions:**

None

**10.33 FLDI1 Floating-point Load Immediate 1.0 Floating-Point Instruction**  
 1.0 Load

---

Format	Summary of Operation	Instruction Code	Execution States	T Bit
FLDI1 FRn	0x3F800000 → FRn	1111nnnn10011101	1	—
—	—	—	—	—

**Description**

When FPSCR.PR = 0, this instruction loads floating-point 1.0 (0x3F800000) into FRn.

**Operation**

```
void FLDI1(int n)
{
    FR[n] = 0x3F800000;
    pc += 2;
}
```

**Possible Exceptions:**

None

**10.34 FLDS Floating-point Load to System register Floating-Point Instruction**  
 Transfer to System Register

---

Format	Summary of Operation	Instruction Code	Execution States	T Bit
FLDS FRm,FPUL	FRm → FPUL	1111mmmm00011101	1	—

**Description**

This instruction loads the contents of floating-point register FRm into system register FPUL.

**Operation**

```
void FLDS(int m, float *FPUL)
{
    *FPUL = FR[m];
    pc += 2;
}
```

**Possible Exceptions:**

None

**10.35 FLOAT Floating-point convert from integer Floating-Point Instruction**  
 Integer to Floating-Point Conversion

---

PR	Format	Summary of Operation	Instruction Code	Execution States	T Bit
0	FLOAT FPUL,FRn	(float)FPUL → FRn	1111nnnn00101101	1	—
1	FLOAT FPUL,DRn	(double)FPUL → DRn	1111nnn000101101	2	—

**Description**

When FPSCR.PR = 0: Taking the contents of FPUL as a 32-bit integer, converts this integer to a single-precision floating-point number and stores the result in FRn.

When FPSCR.PR = 1: Taking the contents of FPUL as a 32-bit integer, converts this integer to a double-precision floating-point number and stores the result in DRn.

When FPSCR.enable.I = 1, an FPU exception trap is generated regardless of whether or not an exception has occurred. When an exception occurs, correct exception information is reflected in FPSCR.cause and FPSCR.flag, and FRn or DRn is not updated. Appropriate processing should therefore be performed by software.

## Operation

```
void FLOAT(int n, float *FPUL)
{
  union {
    double d;
    int l[2];
  } tmp;
  pc += 2;
  clear_cause();
  if(FPSCR.PR==0){
    FR[n] = *FPUL; /* convert from integer to float */
    tmp.d = *FPUL;
    if(tmp.l[1] & 0x1fffffff) inexact();
  } else {
    DR[n>>1] = *FPUL; /* convert from integer to double */
  }
}
```

### Possible Exceptions:

Inexact: Not generated when FPSCR.PR = 1.

## 10.36 FMAC Floating-point Multiply and Accumulate

## Floating-Point Instruction

Floating-Point Multiply and Accumulate

PR	Format	Summary of Operation	Instruction Code	Execution States	T Bit
0	FMAC FR0,FRm,FRn	$FR0 * FRm + FRn \rightarrow FRn$	1111nnnnmmmm1110	1	—
1	—	—	—	—	—

### Description

When FPSCR.PR = 0: This instruction arithmetically multiplies the two single-precision floating-point numbers in FR0 and FRm, arithmetically adds the contents of FRn, and stores the result in FRn.

When FPSCR.enable.O/U/I is set, an FPU exception trap is generated regardless of whether or not an exception has occurred. When an exception occurs, correct exception information is reflected in FPSCR.cause and FPSCR.flag, and FRn or DRn is not updated. Appropriate processing should therefore be performed by software.

### Operation

```
void FMAC(int m,n)
{
    pc += 2;
    clear_cause();
    if(FPSCR_PR == 1) undefined_operation();
    else if((data_type_of(0) == sNaN) ||
            (data_type_of(m) == sNaN) ||
            (data_type_of(n) == sNaN)) invalid(n);
    else if((data_type_of(0) == qNaN) ||
            (data_type_of(m) == qNaN)) qnan(n);
    else if((data_type_of(0) == DENORM) ||
            (data_type_of(m) == DENORM)) set_E();
    else switch (data_type_of(0){
        case NORM: switch (data_type_of(m)){
            case PZERO:
            case NZERO: switch (data_type_of(n)){
                case DENORM: set_E(); break;
            }
        }
    }
}
```

Rev. 3.0, 09/99, page 265 of 396

**HITACHI**



```

        case qNaN:  qnan(n);  break;
        case PZERO:
        case NZERO: zero(n,sign_of(0)^ sign_of(m)^sign_of(n));
break;
        default:   break;
    }
case PINF:
case NINF: switch (data_type_of(n)){
    case DENORM:  set_E(); break;
    case qNaN:   qnan(n); break;
    case PINF:
    case NINF: if(sign_of(0)^ sign_of(m)^sign_of(n))  invalid(n);
                else  inf(n,sign_of(0)^ sign_of(m)); break;
    default:     inf(n,sign_of(0)^ sign_of(m)); break;
}
case NORM: switch (data_type_of(n)){
    case DENORM: set_E();  break;
    case qNaN:  qnan(n);  break;
    case PINF:
    case NINF:  inf(n,sign_of(n)); break;
    case PZERO:
    case NZERO:
    case NORM:  normal_fmac(m,n); break;
}    break;
case PZERO:
case NZERO: switch (data_type_of(m)){
    case PINF:
    case NINF:  invalid(n); break;
    case PZERO:
    case NZERO:
    case NORM: switch (data_type_of(n)){
        case DENORM: set_E();  break;
        case qNaN:  qnan(n);  break;
        case PZERO:
        case NZERO: zero(n,sign_of(0)^ sign_of(m)^sign_of(n));  break;
        default:   break;
    }    break;
}    break;
}    break;

```

```

case PINF :
case NINF : switch (data_type_of(m)){
    case PZERO:
    case NZERO:invalid(n); break;
    default: switch (data_type_of(n)){
        case DENORM: set_E(); break;
        case qNaN:    qnan(n); break;
        default:    inf(n,sign_of(0)^sign_of(m)^sign_of(n));break
    }    break;
    }    break;
}
}
void normal_fmac(int m,n)
{
union {
    int double x;
    int l[4];
}    dstx,tmpx;
float dstf,srcf;
if((data_type_of(n) == PZERO)|| (data_type_of(n) == NZERO))
    srcf = 0.0; /* flush denormalized value */
else    srcf = FR[n];
tmpx.x = FR[0]; /* convert single to int double */
tmpx.x *= FR[m]; /* exact product */
dstx.x = tmpx.x + srcf;
if(((dstx.x == srcf) && (tmpx.x != 0.0)) ||
    ((dstx.x == tmpx.x) && (srcf != 0.0))) {
    set_I();
    if(sign_of(0)^ sign_of(m)^ sign_of(n)) {
        dstx.l[3] -= 1; /* correct result */
        if(dstx.l[3] == 0xffffffff) dstx.l[2] -= 1;
        if(dstx.l[2] == 0xffffffff) dstx.l[1] -= 1;
        if(dstx.l[1] == 0xffffffff) dstx.l[0] -= 1;
    }
    else    dstx.l[3] |= 1;
}
if((dstx.l[1] & 0x01ffffff) || dstx.l[2] || dstx.l[3]) set_I();

```

```
if(FPSCR_RM == 1) {  
    dstx.l[1] &= 0xfe000000; /* round toward zero */  
    dstx.l[2] = 0x00000000;  
    dstx.l[3] = 0x00000000;  
}  
dstf = dstx.x;  
check_single_exception(&FR[n],dstf);  
}
```

### FMAC Special Cases

FRn	FR0	FRm								
		+Norm	-Norm	+0	-0	+INF	-INF	Denorm	qNaN	sNaN
Norm	Norm	MAC				INF				
	0					Invalid				
	INF	INF		Invalid		INF				
+0	Norm	MAC								
	0					+0				
	INF	INF		Invalid		INF				
-0	+Norm	MAC			+0	-0	+INF	-INF		
	-Norm				-0	+0	-INF	+INF		
	+0	+0	-0	+0	-0	Invalid				
	-0	-0	+0	-0	+0					
	INF	INF		Invalid		INF				
+INF	+Norm	+INF						Invalid		
	-Norm							+INF		
	0					Invalid				
	+INF			Invalid		+INF				
	-INF	Invalid	+INF					+INF		
-INF	+Norm	-INF						-INF		
	-Norm									
	0									
	+INF	Invalid	Invalid				-INF			
	-INF	-INF					-INF	Invalid		
Denorm	Norm									
	0					Invalid				
	INF	Invalid								
!sNaN	Denorm							Error		
qNaN	0					Invalid				
	INF	Invalid								
	Norm									
!sNaN	qNaN							qNaN		
All types	sNaN									Invalid
SNaN	all types									

Note: When DN = 1, the value of a denormalized number is treated as 0.

**Possible Exceptions:**

- FPU error
- Invalid operation
- Overflow
- Underflow
- Inexact

**10.37 FMOV Floating-point MOVE Floating-Point Instruction**  
 Floating-Point Transfer

SZ	Format	Summary of Operation	Instruction Code	Execution States	T Bit
0	1. FMOV FRm,FRn	FRm → FRn	1111nnnnmmmm1100	1	—
1	2. FMOV DRm,DRn	DRm → DRn	1111nnn0mmmm01100	1	—
0	3. FMOV.S FRm,@Rn	FRm → (Rn)	1111nnnnmmmm1010	1	—
1	4. FMOV DRm,@Rn	DRm → (Rn)	1111nnnnmmmm01010	1	—
0	5. FMOV.S @Rm,FRn	(Rm) → FRn	1111nnnnmmmm1000	1	—
1	6. FMOV @Rm,DRn	(Rm) → DRn	1111nnn0mmmm1000	1	—
0	7. FMOV.S @Rm+,FRn	(Rm) → FRn,Rm+=4	1111nnnnmmmm1001	1	—
1	8. FMOV @Rm+,DRn	(Rm) → DRn,Rm+=8	1111nnn0mmmm1001	1	—
0	9. FMOV.S FRm,@-Rn	Rn-=4,FRm → (Rn)	1111nnnnmmmm1011	1	—
1	10. FMOV DRm,@-Rn	Rn-=8,DRm → (Rn)	1111nnnnmmmm01011	1	—
0	11. FMOV.S @(R0,Rm),FRn	(R0+Rm) → FRn	1111nnnnmmmm0110	1	—
1	12. FMOV @(R0,Rm),DRn	(R0+Rm) → DRn	1111nnn0mmmm0110	1	—
0	13. FMOV.S FRm,@(R0,Rn)	FRm → (R0+Rn)	1111nnnnmmmm0111	1	—
1	14. FMOV DRm,@(R0,Rn)	DRm → (R0+Rn)	1111nnnnmmmm00111	1	—

**Description**

1. This instruction transfers FRm contents to FRn.
2. This instruction transfers DRm contents to DRn.
3. This instruction transfers FRm contents to memory at address indicated by Rn.
4. This instruction transfers DRm contents to memory at address indicated by Rn.
5. This instruction transfers contents of memory at address indicated by Rm to FRn.
6. This instruction transfers contents of memory at address indicated by Rm to DRn.
7. This instruction transfers contents of memory at address indicated by Rm to FRn, and adds 4 to Rm.
8. This instruction transfers contents of memory at address indicated by Rm to DRn, and adds 8 to Rm.
9. This instruction subtracts 4 from Rn, and transfers FRm contents to memory at address indicated by resulting Rn value.
10. This instruction subtracts 8 from Rn, and transfers DRm contents to memory at address indicated by resulting Rn value.
11. This instruction transfers contents of memory at address indicated by (R0 + Rm) to FRn.

12. This instruction transfers contents of memory at address indicated by (R0 + Rm) to DRn.
13. This instruction transfers FRm contents to memory at address indicated by (R0 + Rn).
14. This instruction transfers DRm contents to memory at address indicated by (R0 + Rn).

### Operation

```

void FMOV(int m,n)                /* FMOV FRm,FRn */
{
    FR[n] = FR[m];
    pc += 2;
}
void FMOV_DR(int m,n)             /* FMOV DRm,DRn */
{
    DR[n>>1] = DR[m>>1];
    pc += 2;
}
void FMOV_STORE(int m,n)         /* FMOV.S FRm,@Rn */
{
    store_int(FR[m],R[n]);
    pc += 2;
}
void FMOV_STORE_DR(int m,n)     /* FMOV DRm,@Rn */
{
    store_quad(DR[m>>1],R[n]);
    pc += 2;
}
void FMOV_LOAD(int m,n)         /* FMOV.S @Rm,FRn */
{
    load_int(R[m],FR[n]);
    pc += 2;
}
void FMOV_LOAD_DR(int m,n)     /* FMOV @Rm,DRn */
{
    load_quad(R[m],DR[n>>1]);
    pc += 2;
}
void FMOV_RESTORE(int m,n)     /* FMOV.S @Rm+,FRn */
{

```

```

        load_int(R[m],FR[n]);
        R[m] += 4;
        pc += 2;
    }
void FMOV_RESTORE_DR(int m,n) /* FMOV @Rm+,DRn */
{
    load_quad(R[m],DR[n>>1]) ;
    R[m] += 8;
    pc += 2;
}
void FMOV_SAVE(int m,n) /* FMOV.S FRm,@-Rn */
{
    store_int(FR[m],R[n]-4);
    R[n] -= 4;
    pc += 2;
}
void FMOV_SAVE_DR(int m,n) /* FMOV DRm,@-Rn */
{
    store_quad(DR[m>>1],R[n]-8);
    R[n] -= 8;
    pc += 2;
}
void FMOV_INDEX_LOAD(int m,n) /* FMOV.S @(R0,Rm),FRn */
{
    load_int(R[0] + R[m],FR[n]);
    pc += 2;
}
void FMOV_INDEX_LOAD_DR(int m,n) /*FMOV @(R0,Rm),DRn */
{
    load_quad(R[0] + R[m],DR[n>>1]);
    pc += 2;
}
void FMOV_INDEX_STORE(int m,n) /*FMOV.S FRm,@(R0,Rn)*/
{
    store_int(FR[m], R[0] + R[n]);
    pc += 2;
}

```



```
void FMOV_INDEX_STORE_DR(int m,n)/*FMOV DRm,@(R0,Rn)*/  
{  
    store_quad(DR[m>>1], R[0] + R[n]);  
    pc += 2;  
}
```

**Possible Exceptions:**

- Data TLB miss exception
- Data protection violation exception
- Initial write exception
- Address error

**10.38 FMOV****Floating-point  
MOVE extension****Floating-Point Instruction**Floating-Point  
Transfer

PR	Format	Summary of Operation	Instruction Code	Execution States	T Bit
1	1. FMOV XDm,@Rn	XRm → (Rn)	1111nnnnmmmm11010	1	—
1	2. FMOV @Rm,XDn	(Rm) → XDn	1111nnn1mmmm1000	1	—
1	3. FMOV @Rm+,XDn	(Rm) → XDn,Rm+=8	1111nnn1mmmm1001	1	—
1	4. FMOV XDm,@-Rn	Rn-=8,XDm → (Rn)	1111nnnnmmmm11011	1	—
1	5. FMOV @(R0,Rm),XDn	(R0+Rm) → XDn	1111nnn1mmmm0110	1	—
1	6. FMOV XDm,@(R0,Rn)	XDm → (R0+Rn)	1111nnnnmmmm10111	1	—
1	7. FMOV XDm,XDn	XDm → XDn	1111nnn1mmmm11100	1	—
1	8. FMOV XDm,DRn	XDm → DRn	1111nnn0mmmm11100	1	—
1	9. FMOV DRm,XDn	DRm → XDn	1111nnn1mmmm01100	1	—

**Description**

1. This instruction transfers XDm contents to memory at address indicated by Rn.
2. This instruction transfers contents of memory at address indicated by Rm to XDn.
3. This instruction transfers contents of memory at address indicated by Rm to XDn, and adds 8 to Rm.
4. This instruction subtracts 8 from Rn, and transfers XDm contents to memory at address indicated by resulting Rn value.
5. This instruction transfers contents of memory at address indicated by (R0 + Rm) to XDn.
6. This instruction transfers XDm contents to memory at address indicated by (R0 + Rn).
7. This instruction transfers XDm contents to XDn.
8. This instruction transfers XDm contents to DRn.
9. This instruction transfers DRm contents to XDn.

## Operation

```
void FMOV_STORE_XD(int m,n)      /* FMOV XDm,@Rn */
{
    store_quad(XD[m>>1],R[n]);
    pc += 2;
}
void FMOV_LOAD_XD(int m,n)      /* FMOV @Rm,XDn */
{
    load_quad(R[m],XD[n>>1]);
    pc += 2;
}
void FMOV_RESTORE_XD(int m,n)  /* FMOV @Rm+,DBn */
{
    load_quad(R[m],XD[n>>1]);
    R[m] += 8;
    pc += 2;
}
void FMOV_SAVE_XD(int m,n)     /* FMOV XDm,@-Rn */
{
    store_quad(XD[m>>1],R[n]-8);
    R[n] -= 8;
    pc += 2;
}
void FMOV_INDEX_LOAD_XD(int m,n) /* FMOV @(R0,Rm),XDn */
{
    load_quad(R[0] + R[m],XD[n>>1]);
    pc += 2;
}
void FMOV_INDEX_STORE_XD(int m,n) /* FMOV XDm,@(R0,Rn) */
{
    store_quad(XD[m>>1], R[0] + R[n]);
    pc += 2;
}
void FMOV_XDXD(int m,n)       /* FMOV XDm,XDn */
{
    XD[n>>1] = XD[m>>1];
    pc += 2;
}
```

```

}
void FMOV_XDDR(int m,n) /* FMOV XDm,DRn */
{
    DR[n>>1] = XD[m>>1];
    pc += 2;
}
void FMOV_DRXD(int m,n) /* FMOV DRm,XDn */
{
    XD[n>>1] = DR[m>>1];
    pc += 2;
}

```

**Possible Exceptions:**

- Data TLB miss exception
- Data protection violation exception
- Initial write exception
- Address error

## 10.39 FMUL Floating-point MULTiply Floating-Point Instruction

Floating-Point Multiplication

---

PR	Format	Summary of Operation	Instruction Code	Execution States	T Bit
0	FMUL FRm,FRn	FRn*FRm → FRn	1111nnnnmmmm0010	1	—
1	FMUL DRm,DRn	DRn*DRm → DRn	1111nnn0mmm00010	6	—

### Description

When FPSCR.PR = 0: Arithmetically multiplies the two single-precision floating-point numbers in FRn and FRm, and stores the result in FRn.

When FPSCR.PR = 1: Arithmetically multiplies the two double-precision floating-point numbers in DRn and DRm, and stores the result in DRn.

When FPSCR.enable.O/U/I is set, an FPU exception trap is generated regardless of whether or not an exception has occurred. When an exception occurs, correct exception information is reflected in FPSCR.cause and FPSCR.flag, and FRn or DRn is not updated. Appropriate processing should therefore be performed by software.

### Operation

```
void FMUL(int m,n)
{
    pc += 2;
    clear_cause();
    if((data_type_of(m) == sNaN) ||
        (data_type_of(n) == sNaN)) invalid(n);
    else if((data_type_of(m) == qNaN) ||
        (data_type_of(n) == qNaN)) qnan(n);
    else if((data_type_of(m) == DENORM) ||
        (data_type_of(n) == DENORM)) set_E();
    else switch (data_type_of(m)){
        case NORM: switch (data_type_of(n)){
            case PZERO:
            case NZERO: zero(n,sign_of(m)^sign_of(n)); break;
            case PINF:
            case NINF: inf(n,sign_of(m)^sign_of(n)); break;
            default: normal_fmula(m,n); break;
        }
    }
}
```

```

    }      break;
    case PZERO:
    case NZERO: switch (data_type_of(n)){
        case PINF:
        case NINF:  invalid(n); break;
        default:    zero(n,sign_of(m)^sign_of(n));break;
    }      break;
    case PINF :
    case NINF : switch (data_type_of(n)){
        case PZERO:
        case NZERO: invalid(n);  break;
        default:    inf(n,sign_of(m)^sign_of(n));break
    }      break;
}
}
}

```

### FMUL Special Cases

FRm,DRm	FRn,DRn							
	NORM	+0	-0	+INF	-INF	DENORM	qNaN	sNaN
NORM	MUL	0		INF		Error	qNaN	Invalid
+0	0	+0	-0	Invalid				
-0		-0	+0					
+INF	INF	Invalid		+INF	-INF			
-INF				-INF	+INF			
DENORM	Error							
qNaN	qNaN							
sNaN	Invalid							

Note: When DN = 1, the value of a denormalized number is treated as 0.

### Possible Exceptions:

- FPU error
- Invalid operation
- Overflow
- Underflow
- Inexact

## 10.40 FNEG Floating-point NEGate value Floating-Point Instruction

Floating-Point  
Sign Inversion

---

PR	Format	Summary of Operation	Instruction Code	Execution States	T Bit
0	FNEG FRn	-FRn → FRn	1111nnnn01001101	1	—
1	FNEG DRn	-DRn → DRn	1111nnn001001101	1	—

### Description

This instruction inverts the most significant bit (sign bit) of the contents of floating-point register FRn/DRn, and stores the result in FRn/DRn.

The cause and flag fields in FPSCR are not updated.

### Operation

```
void FNEG (int n){
    FR[n] = -FR[n];
    pc += 2;
}
```

```
/* Same operation is performed regardless of precision. */
```

### Possible Exceptions:

None

**10.41 FRCHG FR-bit CHanGe Floating-Point Instruction**  
 FR Bit  
 Inversion

PR	Format	Summary of Operation	Instruction Code	Execution States	T Bit
0	FRCHG	FRSCR.FR=¬FRSCR.FR	1111101111111101	1	—
1	—	—	—	—	—

**Description**

This instruction inverts the FR bit in floating-point register FPSCR. When the FR bit in FPSCR is changed, FR0 to FR15 in FPPR0 to FPPR31 become XR0 to XR15, and XR0 to XR15 become FR0 to FR15. When FPSCR.FR = 0, FPPR0 to FPPR15 correspond to FR0 to FR15, and FPPR16 to FPPR31 correspond to XR0 to XR15. When FPSCR.FR = 1, FPPR16 to FPPR31 correspond to FR0 to FR15, and FPPR0 to FPPR15 correspond to XR0 to XR15.

**Operation**

```
void FRCHG() /* FRCHG */
{
    if(FPSCR_PR == 0){
        FPSCR ^= 0x00200000; /* bit 21 */
        PC += 2;
    }
    else undefined_operation();
}
```

**Possible Exceptions:**

None



**10.42 FSCHG**  
SZ Bit  
Inversion

**Sz-bit CHanGe**

**Floating-Point Instruction**

---

<b>PR</b>	<b>Format</b>	<b>Summary of Operation</b>	<b>Instruction Code</b>	<b>Execution States</b>	<b>T Bit</b>
0	FSCHG	FRSCR.SZ=~FRSCR.SZ	111110011111111101	1	—
1	—	—	—	—	—

---

**Description**

This instruction inverts the SZ bit in floating-point register FPSCR. Changing the SZ bit in FPSCR switches FMOV instruction data transfer between one single-precision data unit and a data pair. When FPSCR.SZ = 0, the FMOV instruction transfers one single-precision data unit. When FPSCR.SZ = 1, the FMOV instruction transfers two single-precision data units as a pair.

**Operation**

```
void FSCHG() /* FSCHG */
{
    if(FPSCR_PR == 0){
        FPSCR ^= 0x00100000; /* bit 20 */
        PC += 2;
    }
    else undefined_operation();
}
```

**Possible Exceptions:**

None

## 10.43 FSQRT Floating-point Square Root Floating-Point Instruction

Floating-Point  
Square Root

---

PR	Format	Summary of Operation	Instruction Code	Execution States	T Bit
0	FSQRT FRn	$\sqrt{FRn} \rightarrow FRn$	1111nnnn01101101	9	—
1	FSQRT DRn	$\sqrt{DRn} \rightarrow DRn$	1111nnnn01101101	22	—

### Description

When FPSCR.PR = 0: Finds the arithmetical square root of the single-precision floating-point number in FRn, and stores the result in FRn.

When FPSCR.PR = 1: Finds the arithmetical square root of the double-precision floating-point number in DRn, and stores the result in DRn.

When FPSCR.enable.I is set, an FPU exception trap is generated regardless of whether or not an exception has occurred. When an exception occurs, correct exception information is reflected in FPSCR.cause and FPSCR.flag, and FRn or DRn is not updated. Appropriate processing should therefore be performed by software.

### Operation

```
void FSQRT(int n){
    pc += 2;
    clear_cause();
    switch(data_type_of(n)){
        case NORM :   if(sign_of(n) == 0) normal_fsqrt(n);
                       else          invalid(n); break;
        case DENORM:  if(sign_of(n) == 0) set_E();
                       else          invalid(n); break;
        case PZERO :
        case NZERO :
        case PINF  :   break;
        case NINF  :   invalid(n); break;
        case qNaN  :   qnan(n);   break;
        case sNaN  :   invalid(n); break;
    }
}
void normal_fsqrt(int n)
```

```

{
union {
    float f;
    int l;
}    dstf,tmpf;
union {
    double d;
    int l[2];
}    dstd,tmpd;
union {
    int double x;
    int l[4];
}    tmpx;
if(FPSCR_PR == 0) {
    tmpf.f = FR[n]; /* save destination value */
    dstf.f = sqrt(FR[n]); /* round toward nearest or even */
    tmpd.d = dstf.f; /* convert single to double */
    tmpd.d *= dstf.f;
    if(tmpf.f != tmpd.d) set_I();
    if((tmpf.f < tmpd.d) && (SPSCR_RM == 1))
        dstf.l -= 1; /* round toward zero */
    if(FPSCR & ENABLE_I) fpu_exception_trap();
    else
        FR[n] = dstf.f;
} else {
    tmpd.d = DR[n>>1]; /* save destination value */
    dstd.d = sqrt(DR[n>>1]); /* round toward nearest or even */
    tmpx.x = dstd.d; /* convert double to int double */
    tmpx.x *= dstd.d;
    if(tmpd.d != tmpx.x) set_I();
    if((tmpd.d < tmpx.x) && (SPSCR_RM == 1)) {
        dstd.l[1] -= 1; /* round toward zero */
        if(dstd.l[1] == 0xffffffff) dstd.l[0] -= 1;
    }
    if(FPSCR & ENABLE_I) fpu_exception_trap();
    else
        DR[n>>1] = dstd.d;
}
}
}

```

### FSQRT Special Cases

FRn	+NORM	-NORM	+0	-0	+INF	-INF	qNaN	sNaN
FSQRT(FRn)	SQRT	Invalid	+0	-0	+INF	Invalid	qNaN	Invalid

Note: When DN = 1, the value of a denormalized number is treated as 0.

#### Possible Exceptions:

- FPU error
- Invalid operation
- Inexact

<b>10.44 FSTS</b>	<b>Floating-point STore System register</b>	<b>Floating-Point Instruction</b>
	Transfer from System Register	

---

Format	Summary of Operation	Instruction Code	Execution States	T Bit
FSTS FPUL,FRn	FPUL → FRn	1111nnnn00001101	1	—

**Description**

This instruction transfers the contents of system register FPUL to floating-point register FRn.

**Operation**

```
void FSTS(int n, float *FPUL)
{
    FR[n] = *FPUL;
    pc += 2;
}
```

**Possible Exceptions:**

None

## 10.45 FSUB Floating-point SUBtract

## Floating-Point Instruction

Floating-Point  
Subtraction

PR	Format	Summary of Operation	Instruction Code	Execution States	T Bit
0	FSUB FRm,FRn	FRn-FRm → FRn	1111nnnnmmmm0001	1	—
1	FSUB DRm,DRn	DRn-DRm → DRn	1111nnn0mmmm00001	6	

### Description

When FPSCR.PR = 0: Arithmetically subtracts the single-precision floating-point number in FRm from the single-precision floating-point number in FRn, and stores the result in FRn.

When FPSCR.PR = 1: Arithmetically subtracts the double-precision floating-point number in DRm from the double-precision floating-point number in DRn, and stores the result in DRn.

When FPSCR.enable.O/U/I is set, an FPU exception trap is generated regardless of whether or not an exception has occurred. When an exception occurs, correct exception information is reflected in FPSCR.cause and FPSCR.flag, and FRn or DRn is not updated. Appropriate processing should therefore be performed by software.

### Operation

```
void FSUB (int m,n)
{
    pc += 2;
    clear_cause();
    if((data_type_of(m) == sNaN) ||
        (data_type_of(n) == sNaN)) invalid(n);
    else if((data_type_of(m) == qNaN) ||
        (data_type_of(n) == qNaN)) qnan(n);
    else if((data_type_of(m) == DENORM) ||
        (data_type_of(n) == DENORM)) set_E();
    else switch (data_type_of(m)){
        case NORM: switch (data_type_of(n)){
            case NORM: normal_faddsub(m,n,SUB); break;
            case PZERO:
            case NZERO: register_copy(m,n); FR[n] = -FR[n];break;
            default: break;
        }
    }
}
```

Rev. 3.0, 09/99, page 287 of 396

**HITACHI**

```

    }          break;
case PZERO: break;
case NZERO: switch (data_type_of(n)){
    case NZERO: zero(n,0); break;
    default:    break;
}          break;
case PINF: switch (data_type_of(n)){
    case PINF:  invalid(n);  break;
    default:   inf(n,1);    break;
}  break;
case NINF: switch (data_type_of(n)){
    case NINF:  invalid(n);  break;
    default:   inf(n,0);    break;
}          break;
}
}

```

### FSUB Special Cases

FRm,DRm	FRn,DRn							
	NORM	+0	-0	+INF	-INF	DENORM	qNaN	sNaN
NORM	SUB			+INF	-INF	Error	qNaN	Invalid
+0		-0						
-0	+0							
+INF	-INF			Invalid				
-INF	+INF				Invalid			
DENORM	Error							
qNaN							qNaN	
sNaN								Invalid

Note: When DN = 1, the value of a denormalized number is treated as 0.

### Possible Exceptions:

- FPU error
- Invalid operation
- Overflow
- Underflow
- Inexact

**10.46 FTRC Floating-point TRuncate and Convert to integer Floating-Point Instruction**  
 Conversion to Integer

---

PR	Format	Summary of Operation	Instruction Code	Execution States	T Bit
0	FTRC FRm,FPUL	(long)FRm → FPUL	1111mmmm00111101	1	—
1	FTRC DRm,FPUL	(long)DRm → FPUL	1111mmmm000111101	2	—

**Description**

When FPSCR.PR = 0: Converts the single-precision floating-point number in FRm to a 32-bit integer, and stores the result in FPUL.

When FPSCR.PR = 1: Converts the double-precision floating-point number in FRm to a 32-bit integer, and stores the result in FPUL.

The rounding mode is always truncation.

**Operation**

```
#define N_INT_SINGLE_RANGE 0xcf000000 & 0x7fffffff /* -1.000000 * 2^31 */
#define P_INT_SINGLE_RANGE 0x4effffff /* 1.fffffe * 2^30 */
#define N_INT_DOUBLE_RANGE 0xc1e000000200000 & 0x7fffffffffffffff
#define P_INT_DOUBLE_RANGE 0x41e0000000000000

void FTRC(int m, int *FPUL)
{
    pc += 2;
    clear_cause();
    if(FPSCR.PR==0){
        case(ftrc_single_type_of(m)){
            NORM:    *FPUL = FR[m];    break;
            PINF:    ftrc_invalid(0);  break;
            NINF:    ftrc_invalid(1);  break;
        }
    }
    else{
        /* case FPSCR.PR=1 */
        case(ftrc_double_type_of(m)){
```



```

        NORM:      *FPUL = DR[m>>1]; break;
        PINF:      ftrc_invalid(0); break;
        NINF:      ftrc_invalid(1); break;
    }
}
}
int ftrc_signle_type_of(int m)
{
    if(sign_of(m) == 0){
        if(FR_HEX[m] > 0x7f800000) return(NINF); /* NaN */
        else if(FR_HEX[m] > P_INT_SINGLE_RANGE)
            return(PINF); /* out of range,+INF */
        else return(NORM); /* +0,+NORM */
    } else {
        if((FR_HEX[m] & 0x7fffffff) > N_INT_SINGLE_RANGE)
            return(NINF); /* out of range ,+INF,NaN*/
        else return(NORM); /* -0,-NORM */
    }
}
int ftrc_double_type_of(int m)
{
    if(sign_of(m) == 0){
        if((FR_HEX[m] > 0x7ff00000) ||
            ((FR_HEX[m] == 0x7ff00000) &&
            (FR_HEX[m+1] != 0x00000000))) return(NINF); /* NaN */
        else if(DR_HEX[m>>1] >= P_INT_DOUBLE_RANGE)
            return(PINF); /* out of range,+INF */
        else return(NORM); /* +0,+NORM */
    } else {
        if((DR_HEX[m>>1] & 0x7fffffffffffffff) >= N_INT_DOUBLE_RANGE)
            return(NINF); /* out of range ,+INF,NaN*/
        else return(NORM); /* -0,-NORM */
    }
}
void ftrc_invalid(int sign, int *FPUL)
{
    set_V();
}

```

```

    if((FPSCR & ENABLE_V) == 0){
        if(sign == 0)    *FPUL = 0x7fffffff;
        else            *FPUL = 0x80000000;
    }
    else fpu_exception_trap();
}

```

### FTRC Special Cases

FRn,DRn	NORM	+0	-0	Positive Out of Range	Negative Out of Range	+INF	-INF	qNaN	sNaN
FTRC (FRn,DRn)	TRC	0	0	Invalid +MAX	Invalid -MAX	Invalid +MAX	Invalid -MAX	Invalid -MAX	Invalid -MAX

Note: When DN = 1, the value of a denormalized number is treated as 0.

### Possible Exceptions:

- Invalid operation

**10.47 FTRV****Floating-point  
Transform Vector****Floating-Point Instruction**Vector  
Transformation

PR	Format	Summary of Operation	Instruction Code	Execution States	T Bit
0	FTRV XMTRX,FVn	$\text{XMTRX} \times \text{FVn} \rightarrow \text{FVn}$	1111nn0111111101	4	—
1	—	—	—	—	—

**Description**

When FPSCR.PR = 0: This instruction takes the contents of floating-point registers XF0 to XF15 indicated by XMTRX as a 4-row  $\times$  4-column matrix, takes the contents of floating-point registers FR[n] to FR[n + 3] indicated by FVn as a 4-dimensional vector, multiplies the array by the vector, and stores the results in FV[n].

$$\begin{array}{c} \text{XMTRX} \\ \left[ \begin{array}{cccc} \text{XF}[0] & \text{XF}[4] & \text{XF}[8] & \text{XF}[12] \\ \text{XF}[1] & \text{XF}[5] & \text{XF}[9] & \text{XF}[13] \\ \text{XF}[2] & \text{XF}[6] & \text{XF}[10] & \text{XF}[14] \\ \text{XF}[3] & \text{XF}[7] & \text{XF}[11] & \text{XF}[15] \end{array} \right] \end{array} \times \begin{array}{c} \text{FVn} \\ \left[ \begin{array}{c} \text{FR}[n] \\ \text{FR}[n+1] \\ \text{FR}[n+2] \\ \text{FR}[n+3] \end{array} \right] \end{array} \rightarrow \begin{array}{c} \text{FVn} \\ \left[ \begin{array}{c} \text{FR}[n] \\ \text{FR}[n+1] \\ \text{FR}[n+2] \\ \text{FR}[n+3] \end{array} \right] \end{array}$$

The FTRV instruction is intended for speed rather than accuracy, and therefore the results will differ from those obtained by using a combination of FADD and FMUL instructions. The FTRV execution sequence is as follows:

1. Multiplies all terms. The results are 30 bits long.
2. Aligns these results, rounding them to fit within 28 bits.
3. Adds the aligned values.
4. Performs normalization and rounding.

Special processing is performed in the following cases:

1. If an input value is an sNaN, an invalid exception is generated.
2. If the input values to be multiplied include a combination of 0 and infinity, an invalid operation exception is generated.
3. In cases other than the above, if the input values include a qNaN, the result will be a qNaN.
4. In cases other than the above, if the input values include infinity:
  - a. If multiplication results in two or more infinities and the signs are different, an invalid exception will be generated.
  - b. Otherwise, correct infinities will be stored.

5. If the input values do not include an sNaN, qNaN, or infinity, processing is performed in the normal way.

When FPSCR.enable.V/O/U/I is set, an FPU exception trap is generated regardless of whether or not an exception has occurred. When an exception occurs, correct exception information is reflected in FPSCR.cause and FPSCR.flag, and FRn or DRn is not updated. Appropriate processing should therefore be performed by software.

### Operation

```
void FTRV (int n)      /* FTRV FVn */
{
float saved_vec[4],result_vec[4];
int saved_fpscr;
int dst,i;
    if(FPSCR_PR == 0) {
        PC += 2;
        clear_cause();
        saved_fpscr = FPSCR;
        FPSCR &= ~ENABLE_VOUI; /* mask VOUI enable */
        dst = 12 - n;          /* select other vector than FVn */
        for(i=0;i<4;i++)saved_vec [i] = FR[dst+i];
        for(i=0;i<4;i++){
            for(j=0;j<4;j++) FR[dst+j] = XF[i+4j];
            fipr(n,dst);
            saved_fpscr |= FPSCR & (CAUSE|FLAG) ;
            result_vec [i] = FR[dst+3];
        }
        for(i=0;i<4;i++)FR[dst+i] = saved_vec [i];
        FPSCR = saved_fpscr;
        if(FPSCR & ENABLE_VOUI) fpu_exception_trap();
        else    for(i=0;i<4;i++)  FR[n+i] = result_vec [i];
    }
    else undefined_operation();
}
```

**Possible Exceptions:**

- Invalid operation
- Overflow
- Underflow
- Inexact

**10.48 JMP JuMP**  
Unconditional Branch

**Branch Instruction**  
Delayed Branch Instruction

Format	Summary of Operation	Instruction Code	Execution States	T Bit
JMP @Rn	Rn → PC	0100nnnn00101011	2	—

**Description**

Unconditionally makes a delayed branch to the address specified by Rn.

**Notes**

As this is a delayed branch instruction, the instruction following this instruction is executed before the branch destination instruction.

Interrupts are not accepted between this instruction and the following instruction. If the following instruction is a branch instruction, it is identified as a slot illegal instruction.

**Operation**

```
JMP(int n)/* JMP @Rn */
{
    unsigned int temp;

    temp=PC;
    PC=R[n];
    Delay_Slot(temp+2);
}
```

**Example**

```

MOV.L    JMP_TABLE,R0    ;R0 = TRGET address
JMP      @R0             ;Branch to TRGET.
MOV      R0,R1           ;MOV executed before branch.
.align   4
JMP_TABLE: .data.l TRGET ;Jump table
.....
TRGET:    ADD      #1,R1    ;← Branch destination
```

**10.49 JSR**                    **Jump to SubRoutine**  
Branch to Subroutine Procedure

**Branch Instruction**  
Delayed Branch Instruction

---

<b>Format</b>	<b>Summary of Operation</b>	<b>Instruction Code</b>	<b>Execution States</b>	<b>T Bit</b>
JSR @Rn	PC+4 → PR, Rn → PC	0100n00000001011	2	—

---

**Description**

This instruction makes a delayed branch to the subroutine procedure at the specified address after execution of the following instruction. Return address (PC + 4) is saved in PR, and a branch is made to the address indicated by general register Rn. JSR is used in combination with RTS for subroutine procedure calls.

**Notes**

As this is a delayed branch instruction, the instruction following this instruction is executed before the branch destination instruction.

Interrupts are not accepted between this instruction and the following instruction. If the following instruction is a branch instruction, it is identified as a slot illegal instruction.

**Operation**

```
JSR(int n)/* JSR @Rn */
{
    unsigned int temp;

    temp=PC;
    PR=PC+4;
    PC=R[n];
    Delay_Slot(temp+2);
}
```

## Example

```
MOV.L    JSR_TABLE, R0    ; R0 = TRGET address
JSR      @R0              ; Branch to TRGET.
XOR      R1, R1           ; XOR executed before branch.
ADD      R0, R1           ; ← Procedure return destination (PR contents)
.....
.align   4
JSR_TABLE: .data.l TRGET    ; Jump table
TRGET:    NOP             ; ← Entry to procedure
          MOV            R2, R3 ;
          RTS            ; Return to above ADD instruction.
          MOV            #70, R1 ; MOV executed before RTS.
```



**10.50 LDC Load to Control Register**      **Load to Control register**      **System Control Instruction**  
 Load to Control Register      (Privileged Instruction)

Format	Summary of Operation	Instruction Code	Execution States	T Bit
LDC Rm, SR	Rm → SR	0100mmmm00001110	4	LSB
LDC Rm, GBR	Rm → GBR	0100mmmm00011110	3	—
LDC Rm, VBR	Rm → VBR	0100mmmm00101110	1	—
LDC Rm, SSR	Rm → SSR	0100mmmm00111110	1	—
LDC Rm, SPC	Rm → SPC	0100mmmm01001110	1	—
LDC Rm, DBR	Rm → DBR	0100mmmm11111010	1	—
LDC Rm, R0_BANK	Rm → R0_BANK	0100mmmm10001110	1	—
LDC Rm, R1_BANK	Rm → R1_BANK	0100mmmm10011110	1	—
LDC Rm, R2_BANK	Rm → R2_BANK	0100mmmm10101110	1	—
LDC Rm, R3_BANK	Rm → R3_BANK	0100mmmm10111110	1	—
LDC Rm, R4_BANK	Rm → R4_BANK	0100mmmm11001110	1	—
LDC Rm, R5_BANK	Rm → R5_BANK	0100mmmm11011110	1	—
LDC Rm, R6_BANK	Rm → R6_BANK	0100mmmm11101110	1	—
LDC Rm, R7_BANK	Rm → R7_BANK	0100mmmm11111110	1	—
LDC.L @Rm+, SR	(Rm) → SR, Rm+4 → Rm	0100mmmm00000111	4	LSB
LDC.L @Rm+, GBR	(Rm) → GBR, Rm+4 → Rm	0100mmmm00010111	3	—
LDC.L @Rm+, VBR	(Rm) → VBR, Rm+4 → Rm	0100mmmm00100111	1	—
LDC.L @Rm+, SSR	(Rm) → SSR, Rm+4 → Rm	0100mmmm00110111	1	—
LDC.L @Rm+, SPC	(Rm) → SPC, Rm+4 → Rm	0100mmmm01000111	1	—
LDC.L @Rm+, DBR	(Rm) → DBR, Rm+4 → Rm	0100mmmm11110110	1	—
LDC.L @Rm+, R0_BANK	(Rm) → R0_BANK, Rm+4 → Rm	0100mmmm10000111	1	—
LDC.L @Rm+, R1_BANK	(Rm) → R1_BANK, Rm+4 → Rm	0100mmmm10010111	1	—
LDC.L @Rm+, R2_BANK	(Rm) → R2_BANK, Rm+4 → Rm	0100mmmm10100111	1	—
LDC.L @Rm+, R3_BANK	(Rm) → R3_BANK, Rm+4 → Rm	0100mmmm10110111	1	—
LDC.L @Rm+, R4_BANK	(Rm) → R4_BANK, Rm+4 → Rm	0100mmmm11000111	1	—
LDC.L @Rm+, R5_BANK	(Rm) → R5_BANK, Rm+4 → Rm	0100mmmm11010111	1	—
LDC.L @Rm+, R6_BANK	(Rm) → R6_BANK, Rm+4 → Rm	0100mmmm11100111	1	—
LDC.L @Rm+, R7_BANK	(Rm) → R7_BANK, Rm+4 → Rm	0100mmmm11110111	1	—

**Description**

These instructions store the source operand in the control register SR, GBR, VBR, SSR, SPC, DBR, or R0\_BANK to R7\_BANK.

## Notes

With the exception of LDC Rm,GBR and LDC.L @Rm+,GBR, the LDC/LDC.L instructions are privileged instructions and can only be used in privileged mode. Use in user mode will cause an illegal instruction exception. However, LDC Rm,GBR and LDC.L @Rm+,GBR can also be used in user mode.

With the LDC Rm, Rn\_BANK and LDC.L @Rm, Rn\_BANK instructions, Rn\_BANK0 is accessed when the RB bit in the SR register is 1, and Rn\_BANK1 is accessed when this bit is 0.

## Operation

```
LDCSR(int m)      /* LDC Rm,SR : Privileged */
{
    SR=R[m]&0x700083F3;
    PC+=2;
}

LDCGBR(int m)     /* LDC Rm,GBR */
{
    GBR=R[m];
    PC+=2;
}

LDCVBR(int m)     /* LDC Rm,VBR : Privileged */
{
    VBR=R[m];
    PC+=2;
}

LDCSSR(int m)     /* LDC Rm,SSR : Privileged */
{
    SSR=R[m],
    PC+=2;
}

LDCSPC(int m)     /* LDC Rm,SPC : Privileged */
{
    SPC=R[m];
}
```

```

    PC+=2;
}

LDCDBR(int m)      /* LDC Rm,DBR : Privileged */
{
    DBR=R[m];
    PC+=2;
}

LDCRn_BANK(int m) /* LDC Rm,Rn_BANK : Privileged */
                  /* n=0-7 */
{
    Rn_BANK=R[m];
    PC+=2;
}

LDCMSR(int m)     /* LDC.L @Rm+,SR : Privileged */
{
    SR=Read_Long(R[m])&0x700083F3;
    R[m]+=4;
    PC+=2;
}

LDCMGBR(int m)    /* LDC.L @Rm+,GBR */
{
    GBR=Read_Long(R[m]);
    R[m]+=4;
    PC+=2;
}

LDCMVBR(int m)   /* LDC.L @Rm+,VBR : Privileged */
{
    VBR=Read_Long(R[m]);
    R[m]+=4;
    PC+=2;
}

```

```

LDCMSSR(int m)      /* LDC.L @Rm+,SSR : Privileged */
{
    SSR=Read_Long(R[m]);
    R[m]+=4;
    PC+=2;
}

LDCMSPC(int m)      /* LDC.L @Rm+,SPC : Privileged */
{
    SPC=Read_Long(R[m]);
    R[m]+=4;
    PC+=2;
}

LDCMDBR(int m)      /* LDC.L @Rm+,DBR : Privileged */
{
    DBR=Read_Long(R[m]);
    R[m]+=4;
    PC+=2;
}

LDCMRn_BANK(Long m) /* LDC.L @Rm+,Rn_BANK : Privileged */
/* n=0-7 */
{
    Rn_BANK=Read_Long(R[m]);
    R[m]+=4;
    PC+=2;
}

```

**Possible Exceptions:**

- General illegal instruction exception
- Illegal slot instruction exception
- Data TLB miss exception
- Data TLB protection violation exception
- Address error

## 10.51 LDS

## Load to FPU System register

## System Control Instruction

Load to FPU  
System Register

Format	Summary of Operation	Instruction Code	Execution	
			States	T Bit
LDS Rm,FPUL	Rm → FPUL	0100mmmm01011010	1	—
LDS.L @Rm+,FPUL	(Rm) → FPUL, Rm+4 → Rm	0100mmmm01010110	1	—
LDS Rm,FPSCR	Rm → FPSCR	0100mmmm01101010	1	—
LDS.L @Rm+,FPSCR	(Rm) → FPSCR, Rm+4 → Rm	0100mmmm01100110	1	—

### Description

This instruction loads the source operand into FPU system registers FPUL and FPSCR.

### Operation

```
#define FPSCR_MASK 0x003FFFFFFF

LDSFPUL(int m, int *FPUL)          /* LDS Rm,FPUL */
{
    *FPUL=R[m];
    PC+=2;
}

LDSMFPUL(int m, int *FPUL)        /* LDS.L @Rm+,FPUL */
{
    *FPUL=Read_Long(R[m]);
    R[m]+=4;
    PC+=2;
}

LDSFPSCR(int m)                   /* LDS Rm,FPSCR */
{
    FPSCR=R[m] & FPSCR_MASK;
    PC+=2;
}

LDSMFPSCR(int m)                  /* LDS.L @Rm+,FPSCR */
{
    FPSCR=Read_Long(R[m]) & FPSCR_MASK;
```

```
R[m] += 4;  
PC += 2;  
}
```

**Possible Exceptions:**

- Data TLB miss exception
- Data access protection exception
- Address error

## 10.52 LDS Load to System register System Control Instruction

Load to System Register

---

Format	Summary of Operation	Instruction Code	Execution	
			States	T Bit
LDS Rm,MACH	Rm → MACH	0100mmmm00001010	1	—
LDS Rm,MACL	Rm → MACL	0100mmmm00011010	1	—
LDS Rm,PR	Rm → PR	0100mmmm00101010	2	—
LDS.L @Rm+,MACH	(Rm) → MACH, Rm + 4 → Rm	0100mmmm00000110	1	—
LDS.L @Rm+,MACL	(Rm) → MACL, Rm + 4 → Rm	0100mmmm00010110	1	—
LDS.L @Rm+,PR	(Rm) → PR, Rm + 4 → Rm	0100mmmm00100110	2	—

### Description

Stores the source operand into the system registers MACH, MACL, or PR.

### Operation

```
LDSMACH(int m)    /* LDS Rm,MACH */
{
    MACH=R[m];
    PC+=2;
}
```

```
LDSMACL(int m)    /* LDS Rm,MACL */
{
    MACL=R[m];
    PC+=2;
}
```

```
LDSPR(int m)      /* LDS Rm,PR */
{
    PR=R[m];
    PC+=2;
}
```

```
LDSMMACH(int m)   /* LDS.L @Rm+,MACH */
{
```

```

    MACH=Read_Long(R[m]);
    R[m]+=4;
    PC+=2;
}

LDSMMACL(int m)      /* LDS.L @Rm+,MACL */
{
    MACL=Read_Long(R[m]);
    R[m]+=4;
    PC+=2;
}

LDSMPR(int m)        /* LDS.L @Rm+,PR */
{
    PR=Read_Long(R[m]);
    R[m]+=4;
    PC+=2;
}

```

### Example

LDS	R0,PR	; Before execution	R0 = H'12345678, PR = H'00000000
		; After execution	PR = H'12345678
LDS.L	@R15+,MACL	; Before execution	R15 = H'10000000
		; After execution	R15 = H'10000004, MACL = (H'10000000)



<b>10.53</b>	<b>LDTLB</b>	<b>Load PTEH/PTEL/PTEA to TLB</b>	<b>System Control Instruction</b> (Privileged Instruction)
	Load to TLB		

---

Format	Summary of Operation	Instruction Code	Execution States	T Bit
LDTLB	PTEH/PTEL/PTEA → TLB	0000000000111000	1	—

**Description**

This instruction loads the contents of the PTEH/PTEL/PTEA registers into the TLB (translation lookaside buffer) specified by MMUCR.URC (random counter field in the MMC control register).

LDTLB is a privileged instruction, and can only be used in privileged mode. Use of this instruction in user mode will cause an illegal instruction exception.

**Notes**

As this instruction loads the contents of the PTEH/PTEL/PTEA registers into a TLB, it should be used either with the MMU disabled, or in the P1 or P2 virtual space with the MMU enabled (see section 3, Memory Management Unit, for details). After this instruction is issued, there must be at least one instruction between the LDTLB instruction and issuance of an instruction relating to address to areas P0, U0, and P3 (i.e. BRAF, BSRF, JMP, JSR, RTS, or RTE).

## Operation

```
LDTLB( ) /*LDTLB */
{
    TLB[MMUCR. URC] .ASID=PTEH & 0x000000FF;
    TLB[MMUCR. URC] .VPN=(PTEH & 0xFFFFFC00)>>10;
    TLB[MMUCR. URC] .PPN=(PTEH & 0x1FFFFC00)>>10;
    TLB[MMUCR. URC] .SZ=(PTEL & 0x00000080)>>6 |
        (PTEL & 0x00000010)>>4;
    TLB[MMUCR. URC] .SH=(PTEH & 0x00000002)>>1;
    TLB[MMUCR. URC] .PR=(PTEH & 0x00000060)>>5;
    TLB[MMUCR. URC] .WT=(PTEH & 0x00000001);
    TLB[MMUCR. URC] .C=(PTEH & 0x00000008)>>3;
    TLB[MMUCR. URC] .D=(PTEH & 0x00000004)>>2;
    TLB[MMUCR. URC] .V=(PTEH & 0x00000100)>>8;
    TLB[MMUCR. URC] .SA=(PTEA & 0x00000007);
    TLB[MMUCR. URC] .TC=(PTEA & 0x00000008)>>3;

    PC+=2;
}
```

## Example

```
MOV    @R0,R1      ;Load page table entry (upper) into R1
MOV    R1,@R2      ;Load R1 into PTEH; R2 is PTEH address (H'FF000000)
LDTLB                    ;Load PTEH, PTEL, PTEA registers into TLB
```

## 10.54 MAC.L Multiply and ACcumulate Long

## Arithmetic Instruction

Double-Precision  
Multiply-and-Accumulate  
Operation

Format	Summary of Operation	Instruction Code	Execution States	T Bit
MAC.L @Rm+,@Rn+	Signed, (Rn) × (Rm) + MAC → MAC Rn + 4 → Rn, Rm + 4 → Rm	0000nnnnmmmm1111	2-5	—

### Description

This instruction performs signed multiplication of the 32-bit operands whose addresses are the contents of general registers Rm and Rn, adds the 64-bit result to the MAC register contents, and stores the result in the MAC register. Operands Rm and Rn are each incremented by 4 each time they are read.

If the S bit is 0, the 64-bit result is stored in the linked MACH and MACL registers.

If the S bit is 1, the addition to the MAC register contents is a saturation operation at the 48th bit from the LSB. In a saturation operation, only the lower 48 bits of the MAC register are valid, and the result range is limited to H'FFFF800000000000 (minimum value) to H'00007FFFFFFFFFFFFF (maximum value).

### Operation

```
MACL(long m, long n) /* MAC.L @Rm+,@Rn+ */
{
    unsigned long RnL,RnH,RmL,RmH,Res0,Res1,Res2;
    unsigned long temp0,temp1,temp2,temp3;
    long tempm,tempn,fnLmL;

    tempn=(long)Read_Long(R[n]);
    R[n]+=4;
    tempm=(long)Read_Long(R[m]);
    R[m]+=4;

    if ((long)(tempn^tempm)<0) fnLmL=-1;
    else fnLmL=0;
}
```

```

if (tempn<0) tempn=0-tempn;
if (tempm<0) tempm=0-tempm;

temp1=(unsigned long)tempn;
temp2=(unsigned long)tempm;

RnL=temp1&0x0000FFFF;
RnH=(temp1>>16)&0x0000FFFF;
RmL=temp2&0x0000FFFF;
RmH=(temp2>>16)&0x0000FFFF;
temp0=RmL*RnL;
temp1=RmH*RnL;
temp2=RmL*RnH;
temp3=RmH*RnH;

Res2=0;

Res1=temp1+temp2;
if (Res1<temp1) Res2+=0x00010000;

temp1=(Res1<<16)&0xFFFF0000;
Res0=temp0+temp1;
if (Res0<temp0) Res2++;

Res2=Res2+((Res1>>16)&0x0000FFFF)+temp3;

if(fnLmL<0){
    Res2=~Res2;
    if (Res0==0) Res2++;
    else Res0=(~Res0)+1;
}
if(S==1){
    Res0=MACL+Res0;
    if (MACL>Res0) Res2++;
    if (MACH&0x00008000);
    else Res2+=MACH|0xFFFF0000;
}

```

```

        Res2+=MACH&0x00007FFF;

if(((long)Res2<0)&&(Res2<0xFFFF8000)){
    Res2=0xFFFF8000;
    Res0=0x00000000;
}
if(((long)Res2>0)&&(Res2>0x00007FFF)){
    Res2=0x00007FFF;
    Res0=0xFFFFFFFF;
};

MACH=(Res2&0x0000FFFF)|(MACH&0xFFFF0000);
MACL=Res0;
}
else {
    Res0=MACL+Res0;
    if (MACL>Res0) Res2++;
    Res2+=MACH;

    MACH=Res2;
    MACL=Res0;
}
PC+=2;
}

```

## Example

```
MOVA    TBLM, R0          ; Get table address
MOV     R0, R1            ;
MOVA    TBLN, R0          ; Get table address
CLRMAC                      ; MAC register initialization
MAC.L   @R0+, @R1+        ;
MAC.L   @R0+, @R1+        ;
STS     MACL, R0          ; Get result in R0
.....
.align  2                 ;
TBLM   .data.1 H'1234ABCD ;
       .data.1 H'5678EF01 ;
TBLN   .data.1 H'0123ABCD ;
       .data.1 H'4567DEF0 ;
```

**10.55 MAC.W Multiply and Accumulate Word Arithmetic Instruction**

Single-Precision  
Multiply-and-Accumulate  
Operation

Format	Summary of Operation	Instruction Code	Execution States	T Bit
MAC.W @Rm+,@Rn+	Signed, (Rn) × (Rm) + MAC →MAC	0100nnnnmmmm1111	2-5	—
MAC @Rm+,@Rn+	Rn + 2 → Rn, Rm + 2 → Rm			

**Description**

This instruction performs signed multiplication of the 16-bit operands whose addresses are the contents of general registers Rm and Rn, adds the 32-bit result to the MAC register contents, and stores the result in the MAC register. Operands Rm and Rn are each incremented by 2 each time they are read.

If the S bit is 0, a  $16 \times 16 + 64 \rightarrow 64$ -bit multiply-and-accumulate operation is performed, and the 64-bit result is stored in the linked MACH and MACL registers.

If the S bit is 1, a  $16 \times 16 + 32 \rightarrow 32$ -bit multiply-and-accumulate operation is performed, and the addition to the MAC register contents is a saturation operation. In a saturation operation, only the MACL register is valid, and the result range is limited to H'80000000 (minimum value) to H'7FFFFFFF (maximum value). If overflow occurs, the LSB of the MACH register is set to 1. H'80000000 (minimum value) is stored in the MACL register if the result overflows in the negative direction, and H'7FFFFFFF (maximum value) is stored if the result overflows in the positive direction

**Notes**

If the S bit is 0, a  $16 \times 16 + 64 \rightarrow 64$ -bit multiply-and-accumulate operation is performed.

## Operation

```
MACW(long m, long n) /* MAC.W @Rm+,@Rn+ */
{
    long tempm,tempn,dest,src,ans;
    unsigned long templ;
    tempn=(long)Read_Word(R[n]);
    R[n]+=2;
    tempm=(long)Read_Word(R[m]);
    R[m]+=2;
    templ=MACL;
    tempm=((long)(short)tempn*(long)(short)tempm);
    if ((long)MACL>=0) dest=0;
    else dest=1;
    if ((long)tempm>=0) {
        src=0;
        tempn=0;
    }
    else {
        src=1;
        tempn=0xFFFFFFFF;
    }
    src+=dest;
    MACL+=tempm;
    if ((long)MACL>=0) ans=0;
    else ans=1;
    ans+=dest;
    if (S==1) {
        if (ans==1) {
            if (src==0) MACL=0x7FFFFFFF;
            if (src==2) MACL=0x80000000;
        }
    }
    else {
        MACH+=tempn;
        if (templ>MACL) MACH+=1;
    }
}
```



```

    PC+=2;
}

```

**Example**

```

    MOVA      TBLM,R0      ; Get table address
    MOV       R0,R1      ;
    MOVA      TBLN,R0      ; Get table address
    CLRMAC    ; MAC register initialization
    MAC.W     @R0+,@R1+    ;
    MAC.W     @R0+,@R1+    ;
    STS       MACL,R0     ; Get result in R0
    .....
    .align 2      ;
TBLM      .data.w     H'1234      ;
          .data.w     H'5678      ;
TBLN      .data.w     H'0123      ;
          .data.w     H'4567      ;

```

**10.56 MOV****MOVE data****Data Transfer Instruction**

Data Transfer

<b>Format</b>	<b>Summary of Operation</b>	<b>Instruction Code</b>	<b>Execution States</b>	<b>T Bit</b>
MOV Rm,Rn	Rm → Rn	0110nnnnmmmm0011	1	—
MOV.B Rm,@Rn	Rm → (Rn)	0010nnnnmmmm0000	1	—
MOV.W Rm,@Rn	Rm → (Rn)	0010nnnnmmmm0001	1	—
MOV.L Rm,@Rn	Rm → (Rn)	0010nnnnmmmm0010	1	—
MOV.B @Rm,Rn	(Rm) sign extension Rn	0110nnnnmmmm0000	1	—
MOV.W @Rm,Rn	(Rm) sign extension Rn	0110nnnnmmmm0001	1	—
MOV.L @Rm,Rn	(Rm) → Rn	0110nnnnmmmm0010	1	—
MOV.B Rm,@-Rn	Rn-1 → Rn, Rm → (Rn)	0010nnnnmmmm0100	1	—
MOV.W Rm,@-Rn	Rn-2 → Rn, Rm → (Rn)	0010nnnnmmmm0101	1	—
MOV.L Rm,@-Rn	Rn-4 → Rn, Rm → (Rn)	0010nnnnmmmm0110	1	—
MOV.B @Rm+,Rn	(Rm) sign extension Rn, Rm+1 → Rm	0110nnnnmmmm0100	1	—
MOV.W @Rm+,Rn	(Rm) sign extension Rn, Rm+2 → Rm	0110nnnnmmmm0101	1	—
MOV.L @Rm+,Rn	(Rm) → Rn, Rm+4 → Rm	0110nnnnmmmm0110	1	—
MOV.B Rm,@(R0,Rn)	Rm → (R0+Rn)	0000nnnnmmmm0100	1	—
MOV.W Rm,@(R0,Rn)	Rm → (R0+Rn)	0000nnnnmmmm0101	1	—
MOV.L Rm,@(R0,Rn)	Rm → (R0+Rn)	0000nnnnmmmm0110	1	—
MOV.B @(R0,Rm),Rn	(R0+Rm) sign extension Rn	0000nnnnmmmm1100	1	—
MOV.W @(R0,Rm),Rn	(R0+Rm) sign extension Rn	0000nnnnmmmm1101	1	—
MOV.L @(R0,Rm),Rn	(R0+Rm) → Rn	0000nnnnmmmm1110	1	—

**Description**

This instruction transfers the source operand to the destination. When an operand is memory, the data size can be specified as byte, word, or longword. When the source operand is memory, the loaded data is sign-extended to longword before being stored in the register.

## Operation

```
MOV(long m, long n) /* MOV Rm,Rn */
{
    R[n]=R[m];
    PC+=2;
}

MOVBS(long m, long n) /* MOV.B Rm,@Rn */
{
    Write_Byte(R[n],R[m]);
    PC+=2;
}

MOVWS(long m, long n) /* MOV.W Rm,@Rn */
{
    Write_Word(R[n],R[m]);
    PC+=2;
}

MOVLS(long m, long n) /* MOV.L Rm,@Rn */
{
    Write_Long(R[n],R[m]);
    PC+=2;
}

MOVBL(long m, long n) /* MOV.B @Rm,Rn */
{
    R[n]=(long)Read_Byte(R[m]);
    if ((R[n]&0x80)==0) R[n]&=0x000000FF;
    else R[n]|=0xFFFFF00;
    PC+=2;
}

MOVWL(long m, long n) /* MOV.W @Rm,Rn */
{
    R[n]=(long)Read_Word(R[m]);
    if ((R[n]&0x8000)==0) R[n]&=0x0000FFFF;
```

```

        else R[n]|=0xFFFF0000;
        PC+=2;
    }

MOVLL(long m, long n) /* MOV.L @Rm,Rn */
{
    R[n]=Read_Long(R[m]);
    PC+=2;
}

MOVBM(long m, long n) /* MOV.B Rm,@-Rn */
{
    Write_Byte(R[n]-1,R[m]);
    R[n]-=1;
    PC+=2;
}

MOVWM(long m, long n) /* MOV.W Rm,@-Rn */
{
    Write_Word(R[n]-2,R[m]);
    R[n]-=2;
    PC+=2;
}

MOVLM(long m, long n) /* MOV.L Rm,@-Rn */
{
    Write_Long(R[n]-4,R[m]);
    R[n]-=4;
    PC+=2;
}

MOVBP(long m, long n) /* MOV.B @Rm+,Rn */
{
    R[n]=(long)Read_Byte(R[m]);
    if ((R[n]&0x80)==0) R[n]&=0x000000FF;
    else R[n]|=0FFFFFF0;
    if (n!=m) R[m]+=1;
}

```

```

        PC+=2;
    }
MOVWP(long m, long n) /* MOV.W @Rm+,Rn */
{
    R[n]=(long)Read_Word(R[m]);
    if ((R[n]&0x8000)==0) R[n]&=0x0000FFFF;
    else R[n]|=0xFFFF0000;
    if (n!=m) R[m]+=2;
    PC+=2;
}

MOVLPL(long m, long n) /* MOV.L @Rm+,Rn */
{
    R[n]=Read_Long(R[m]);
    if (n!=m) R[m]+=4;
    PC+=2;
}

MOVBS0(long m, long n) /* MOV.B Rm,@(R0,Rn) */
{
    Write_Byte(R[n]+R[0],R[m]);
    PC+=2;
}

MOVWS0(long m, long n) /* MOV.W Rm,@(R0,Rn) */
{
    Write_Word(R[n]+R[0],R[m]);
    PC+=2;
}

MOVLS0(long m, long n) /* MOV.L Rm,@(R0,Rn) */
{
    Write_Long(R[n]+R[0],R[m]);
    PC+=2;
}

MOVBL0(long m, long n) /* MOV.B @(R0,Rm),Rn */

```

```

{
    R[n]=(long)Read_Byte(R[m]+R[0]);
    if ((R[n]&0x80)==0) R[n]&=0x000000FF;
    else R[n]|=0xFFFFF00;
    PC+=2;
}

MOVWL0(long m, long n) /* MOV.W @(R0,Rm),Rn */
{
    R[n]=(long)Read_Word(R[m]+R[0]);
    if ((R[n]&0x8000)==0) R[n]&=0x0000FFFF;
    else R[n]|=0xFFFF0000;
    PC+=2;
}

MOVL0(long m, long n) /* MOV.L @(R0,Rm),Rn */
{
    R[n]=Read_Long(R[m]+R[0]);
    PC+=2;
}

```

### Example

MOV	R0,R1	; Before execution	R0 = H'FFFFFFFF, R1 = H'00000000
		; After execution	R1 = H'FFFFFFFF
MOV.W	R0,@R1	; Before execution	R0 = H'FFFF7F80
		; After execution	(R1) = H'7F80
MOV.B	@R0,R1	; Before execution	(R0) = H'80, R1 = H'00000000
		; After execution	R1 = H'FFFFFF80
MOV.W	R0,@-R1	; Before execution	R0 = H'AAAAAAAA, (R1) = H'FFFF7F80
		; After execution	R1 = H'FFFF7F7E, (R1) = H'AAAA
MOV.L	@R0+,R1	; Before execution	R0 = H'12345670
		; After execution	R0 = H'12345674, R1 = (H'12345670)
MOV.B	R1,@(R0,R2)	; Before execution	R2 = H'00000004, R0 = H'10000000
		; After execution	R1 = (H'10000004)
MOV.W	@(R0,R2),R1	; Before execution	R2 = H'00000004, R0 = H'10000000
		; After execution	R1 = (H'10000004)

**10.57 MOV MOVE constant value Data Transfer Instruction**  
 Immediate Data Transfer

Format	Summary of Operation	Instruction Code	Execution States	T Bit
MOV #imm,Rn	imm sign extension Rn	1110nnnniiiiiii	1	—
MOV.W @(disp,PC),Rn	(disp×2+PC+4) → sign extension Rn	1001nnnnddddddd	1	—
MOV.L @(disp,PC),Rn	(disp×4+PC+4) → Rn	1101nnnnddddddd	1	—

**Description**

This instruction stores immediate data, sign-extended to longword, in general register Rn. In the case of word or longword data, the data is stored from memory address (PC + 4 + displacement × 2) or (PC + 4 + displacement × 4).

With word data, the 8-bit displacement is multiplied by two after zero-extension, and so the relative distance from the table is in the range up to PC + 4 + 510 bytes. The PC value is the address of this instruction.

With longword data, the 8-bit displacement is multiplied by four after zero-extension, and so the relative distance from the operand is in the range up to PC + 4 + 1020 bytes. The PC value is the address of this instruction. A value with the lower 2 bits adjusted to B'00 is used in address calculation.

**Notes**

If a PC-relative load instruction is executed in a delay slot, an illegal slot instruction exception will be generated.

## Operation

```
MOVI(int i, int n) /* MOV #imm,Rn */
{
    if ((i&0x80)==0) R[n]=(0x000000FF & i);
    else R[n]=(0xFFFFFFFF00 | i);
    PC+=2;
}

MOVWI(d, n) /* MOV.W @(disp,PC),Rn */
{
    unsigned int disp;

    disp=(unsigned int)(0x000000FF & d);
    R[n]=(int)Read_Word(PC+4+(disp<<1));
    if ((R[n]&0x8000)==0) R[n]&=0x0000FFFF;
    else R[n]|=0xFFFF0000;
    PC+=2;
}

MOVLI(int d, int n)/* MOV.L @(disp,PC),Rn */
{
    unsigned int disp;

    disp=(unsigned int)(0x000000FF & (int)d);
    R[n]=Read_Long((PC&0xFFFFFFFF)+4+(disp<<2));
    PC+=2;
}
```



## Example

```
Address
1000    MOV        #H'80,R1      ;R1 = H'FFFFFF80
1002    MOV.W     IMM,R2        ;R2 = H'FFF9ABC   IMM means (PC + 4 + H'08)
1004    ADD        #-1,R0       ;
1006    TST       R0,R0        ;
1008    MOV.L     @(3,PC),R3    ;R3 = H'12345678
100A    BRA       NEXT        ;Delayed branch instruction
100C    NOP
100E IMM .data.w   H'9ABC      ;
1010    .data.w   H'1234      ;
1012 NEXT JMP     @R3         ;BRA branch instruction
1014    CMP/EQ    #0,R0       ;
        .align   4           ;
1018    .data.l   H'12345678  ;
101C    .data.l   H'9ABCDEF0  ;
```

**10.58 MOV**                      **MOVE global data**                      **Data Transfer Instruction**  
 Global Data  
 Transfer

---

<b>Format</b>	<b>Summary of Operation</b>	<b>Instruction Code</b>	<b>Execution States</b>	<b>T Bit</b>
MOV.B @(disp,GBR),R0	(disp+GBR) → sign extension R0	11000100ddddddd	1	—
MOV.W @(disp,GBR), R0	(disp×2+GBR) → sign extension R0	11000101ddddddd	1	—
MOV.L @(disp,GBR),R0	(disp×4+GBR) → R0	11000110ddddddd	1	—
MOV.B R0,@(disp,GBR)	R0 → (disp+GBR)	11000000ddddddd	1	—
MOV.W R0,@(disp,GBR)	R0 → (disp×2+GBR)	11000001ddddddd	1	—
MOV.L R0,@(disp,GBR)	R0 → (disp×4+GBR)	11000010ddddddd	1	—

**Description**

This instruction transfers the source operand to the destination. Byte, word, or longword can be specified as the data size, but the register is always R0. If the transfer data is byte-size, the 8-bit displacement is only zero-extended, so a range up to +255 bytes can be specified. If the transfer data is word-size, the 8-bit displacement is multiplied by two after zero-extension, enabling a range up to +510 bytes to be specified. With longword transfer data, the 8-bit displacement is multiplied by four after zero-extension, enabling a range up to +1020 bytes to be specified.

When the source operand is memory, the loaded data is sign-extended to longword before being stored in the register.

**Notes**

When loading, the destination register is always R0.

## Operation

```
MOVBLG(int d) /* MOV.B @(disp,GBR),R0 */
{
    unsigned int disp;

    disp=(unsigned int)(0x000000FF & d);
    R[0]=(int)Read_Byte(GBR+disp);
    if ((R[0]&0x80)==0) R[0]&=0x000000FF;
    else R[0]|=0xFFFFF00;
    PC+=2;
}

MOVWLG(int d) /* MOV.W @(disp,GBR),R0 */
{
    unsigned int disp;

    disp=(unsigned int)(0x000000FF & d);

    R[0]=(int)Read_Word(GBR+(disp<<1));
    if ((R[0]&0x8000)==0) R[0]&=0x0000FFFF;
    else R[0]|=0xFFFF0000;
    PC+=2;
}

MOVLG(int d) /* MOV.L @(disp,GBR),R0 */
{
    unsigned int disp;

    disp=(unsigned int)(0x000000FF & d);
    R[0]=Read_Long(GBR+(disp<<2));
    PC+=2;
}

MOVBSG(int d) /* MOV.B R0,@(disp,GBR) */
{
    unsigned int disp;
```

```

        disp=(unsigned int)(0x000000FF & d);
        Write_Byte(GBR+disp,R[0]);
        PC+=2;
    }

MOVWSG(int d) /* MOV.W R0,@(disp,GBR) */
{
    unsigned int disp;

    disp=(unsigned int)(0x000000FF & d);
    Write_Word(GBR+(disp<<1),R[0]);
    PC+=2;
}

MOVLSG(int d) /* MOV.L R0,@(disp,GBR) */
{
    unsigned int disp;

    disp=(unsigned int)(0x000000FF & (long)d);
    Write_Long(GBR+(disp<<2),R[0]);
    PC+=2;
}

```

### Example

```

MOV.L @(2,GBR),R0 ; Before execution (GBR+8) = H'12345670
                ; After execution   R0 = (H'12345670)

MOV.B R0,@(1,GBR) ; Before execution R0 = H'FFFF7F80
                ; After execution   (GBR+1) = H'80

```

**10.59 MOV**      **MOVE structure data**      **Data Transfer Instruction**  
 Structure Data  
 Transfer

Format	Summary of Operation	Instruction Code	Execution States	T Bit
MOV.B R0,@(disp,Rn)	R0 → (disp+Rn)	10000000nnnnndddd	1	—
MOV.W R0,@(disp,Rn)	R0 → (disp×2+Rn)	10000001nnnnndddd	1	—
MOV.L Rm,@(disp,Rn)	Rm → (disp×4+Rn)	0001nnnnmmmmndddd	1	—
MOV.B @(disp,Rm),R0	(disp+Rm) → sign extension R0	10000100mmmmndddd	1	—
MOV.W @(disp,Rm),R0	(disp×2+Rm) → sign extension R0	10000101mmmmndddd	1	—
MOV.L @(disp,Rm),Rn	(disp×4+Rm) → Rn	0101nnnnmmmmndddd	1	—

**Description**

This instruction transfers the source operand to the destination. It is ideal for accessing data inside a structure or stack. Byte, word, or longword can be specified as the data size, but with byte or word data the register is always R0.

If the data is byte-size, the 4-bit displacement is only zero-extended, so a range up to +15 bytes can be specified. If the data is word-size, the 4-bit displacement is multiplied by two after zero-extension, enabling a range up to +30 bytes to be specified. With longword data, the 4-bit displacement is multiplied by four after zero-extension, enabling a range up to +60 bytes to be specified. If a memory operand cannot be reached, the previously described @(R0,Rn) mode must be used.

When the source operand is memory, the loaded data is sign-extended to longword before being stored in the register.

**Notes**

When loading byte or word data, the destination register is always R0. Therefore, if the following instruction attempts to reference R0, it is kept waiting until completion of the load instruction. This allows optimization by changing the order of instructions.

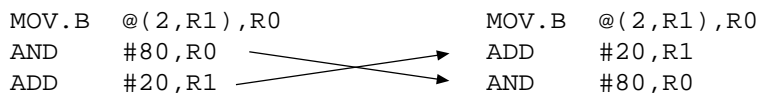

## Operation

```
MOVBS4(long d, long n /* MOV.B R0,@(disp,Rn) */
{
    long disp;
    disp=(0x0000000F & (long)d);
    Write_Byte(R[n]+disp,R[0]);
    PC+=2;
}

MOVWS4(long d, long n /* MOV.W R0,@(disp,Rn) */
{
    long disp;

    disp=(0x0000000F & (long)d);
    Write_Word(R[n]+(disp<<1),R[0]);
    PC+=2;
}

MOVLS4(long m, long d, long n /* MOV.L Rm,@(disp,Rn) */
{
    long disp;

    disp=(0x0000000F & (long)d);
    Write_Long(R[n]+(disp<<2),R[m]);
    PC+=2;
}

MOVBL4(long m, long d /* MOV.B @(disp,Rm),R0 */
{
    long disp;

    disp=(0x0000000F & (long)d);
    R[0]=Read_Byte(R[m]+disp);
    if ((R[0]&0x80)==0) R[0]&=0x000000FF;
    else R[0]|=0xFFFFF00;
    PC+=2;
}
```

```

MOVWL4(long m, long d) /* MOV.W @(disp,Rm),R0 */
{
    long disp;

    disp=(0x0000000F & (long)d);
    R[0]=Read_Word(R[m]+(disp<<1));
    if ((R[0]&0x8000)==0) R[0]&=0x0000FFFF;
    else R[0]|=0xFFFF0000;
    PC+=2;
}

MOVLL4(long m, long d, long n) /* MOV.L @(disp,Rm),Rn */
{
    long disp;

    disp=(0x0000000F & (long)d);
    R[n]=Read_Long(R[m]+(disp<<2));
    PC+=2;
}

```

### Example

MOV.L	@(2,R0),R1	; Before execution (R0+8) = H'12345670
		; After execution R1 = (H'12345670)
MOV.L	R0,@(H'F,R1)	; Before execution R0 = H'FFFF7F80
		; After execution (R1+60) = H'FFFF7F80

## 10.60 MOVA MOVE effective Address Data Transfer Instruction

Effective Address  
Transfer

---

Format	Summary of Operation	Instruction Code	Execution States	T Bit
MOVA @(disp,PC),R0	disp×4+PC+4 → R0	11000111ddddddd	1	—

### Description

This instruction stores the source operand effective address in general register R0. The 8-bit displacement is multiplied by four after zero-extension. The PC value is the address of this instruction, but a value with the lower 2 bits adjusted to B'00 is used in address calculation.

### Notes

If this instruction is executed in a delay slot, an illegal slot instruction exception will be generated.

### Operation

```
MOVA(int d)          /* MOVA @(disp,PC),R0 */
{
    unsigned int disp;

    disp=(unsigned int)(0x000000FF & d);
    R[0]=(PC&0xFFFFFFF0)+4+(disp<<2);
    PC+=2;
}
```

### Example

```
Address .org    H'1006
1006   MOVA    STR,R0      ;STR address → R0
1008   MOV.B   @R0,R1     ;R1 = "X" ← Position after adjustment of lower 2 bits of PC
100A   ADD     R4,R5      ;← Original PC position in MOVA instruction address calculation
      .align  4
100C   STR: .sdata "XYZP12"
```



## 10.61 MOVCA.L MOVE with Cache block Allocation

## Data Transfer Instruction

Cache Block Allocation

---

Format	Summary of Operation	Instruction Code	Execution States	T Bit
MOVCA.L R0,@Rn	R0 → (Rn)	0000nnnn11000011	1	—

---

### Description

This instruction stores the contents of general register R0 in the memory location indicated by effective address Rn. This instruction differs from other store instructions as follows.

If write-back is selected for the accessed memory, and a cache miss occurs, the cache block will be allocated but an R0 data write will be performed to that cache block without performing a block read. Other cache block contents are undefined.

### Operation

```
MOVCA.L(int n)      /*MOVCA.L R0,@Rn */
{
    if ((is_write_back_memory(R[n]))
        && (look_up_in_operand_cache(R[n]) == MISS))
        allocate_operand_cache_block(R[n]);
    Write_Long(R[n], R[0]);
    PC+=2;
}
```

### Possible Exceptions:

- Data TLB miss exception
- Data TLB protection violation exception
- Initial page write exception
- Address error

## 10.62 MOV T bit T Bit Transfer

## Data Transfer Instruction

Format	Summary of Operation	Instruction Code	Execution States	T Bit
MOV T Rn	T → Rn	0000nnnn00101001	1	—

### Description

This instruction stores the T bit in general register Rn. When T = 1, Rn = 1; when T = 0, Rn = 0.

### Operation

```
MOV T(long n)          /* MOV T Rn */
{
    R[n]=(0x00000001 & SR);
    PC+=2;
}
```

### Example

```
XOR        R2,R2      ;R2 = 0
CMP/PZ     R2         ;T = 1
MOV T      R0         ;R0 = 1
CLRT                       ;T = 0
MOV T      R1         ;R1 = 0
```

**10.63 MUL.L MULtiple Long**  
 Double-Precision  
 Multiplication

**Arithmetic Instruction**

Format	Summary of Operation	Instruction Code	Execution States	T Bit
MUL.L Rm,Rn	Rn×Rm → MACL	0000nnnnmmmm0111	2-5	—

**Description**

This instruction performs 32-bit multiplication of the contents of general registers Rn and Rm, and stores the lower 32 bits of the result in the MACL register. The contents of MACH are not changed.

**Operation**

```
MULL(long m, long n) /* MUL.L Rm,Rn */
{
    MACL=R[n]*R[m];
    PC+=2;
}
```

**Example**

```
MUL.L    R0,R1    ; Before execution  R0 = H'FFFFFFFE, R1 = H'00005555
           ; After execution   MACL = H'FFFF5556
STS      MACL,R0  ; Get operation result
```

**10.64 MULS.W      MULtiplly as Signed Word      Arithmetic Instruction**  
 Signed  
 Multiplication

---

Format	Summary of Operation	Instruction Code	Execution States	T Bit
MULS.W Rm,Rn	Signed, $Rn \times Rm \rightarrow MACL$	0010nnnnmmmm1111	2-5	—
MULS Rm,Rn				

**Description**

This instruction performs 16-bit multiplication of the contents of general registers Rn and Rm, and stores the 32-bit result in the MACL register. The multiplication is performed as a signed arithmetic operation. The contents of MACH are not changed.

**Operation**

```
MULS(long m, long n) /* MULS Rm,Rn */
{
    MACL=((long)(short)R[n]*((long)(short)R[m]));
    PC+=2;
}
```

**Example**

```
MULS.W      R0,R 1      ; Before execution R0 = H'FFFFFFFE, R1 = H'00005555
                         ; After execution MACL = H'FFFF5556
STS          MACL,R0     ; Get operation result
```

## 10.65 MULU.W MULtiply as Unsigned Word Arithmetic Instruction

### Unsigned Multiplication

---

Format	Summary of Operation	Instruction Code	Execution States	T Bit
MULU.W Rm,Rn	Unsigned, $Rn \times Rm \rightarrow MACL$	0010nnnnnnmmmm1110	2-5	—
MULU Rm,Rn				

---

### Description

This instruction performs 16-bit multiplication of the contents of general registers Rn and Rm, and stores the 32-bit result in the MACL register. The multiplication is performed as an unsigned arithmetic operation. The contents of MACH are not changed.

### Operation

```
MULU(long m, long n) /* MULU Rm,Rn */
{
    MACL=((unsigned long)(unsigned short)R[n]*
(unsigned long)(unsigned short)R[m]);
    PC+=2;
}
```

### Example

```
MULU.W    R0,R1    ; Before execution  R0 = H'00000002, R1 = H'FFFFAAAA
           ; After execution  MACL = H'00015554
STS       MACL,R0  ; Get operation result
```

## 10.66 NEG      NEGate

Sign Inversion

## Arithmetic Instruction

---

Format	Summary of Operation	Instruction Code	Execution States	T Bit
NEG Rm,Rn	0-Rm → Rn	0110nnnnnnmm1011	1	—

---

### Description

This instruction finds the two's complement of the contents of general register Rm and stores the result in Rn. That is, it subtracts Rm from 0 and stores the result in Rn.

### Operation

```
NEG(long m, long n) /* NEG Rm,Rn */
{
    R[n]=0-R[m];
    PC+=2;
}
```

### Example

```
NEG R0,R1                   ; Before execution R0 = H'00000001
                             ; After execution R1 = H'FFFFFFF
```

**10.67 NEGC**      **NEGate with Carry**  
 Sign Inversion with Borrow

**Arithmetic Instruction**

Format	Summary of Operation	Instruction Code	Execution States	T Bit
NEGC Rm,Rn	0 – Rm – T → Rn, borrow → T	0110nnnnnnmmmm1010	1	Borrow

**Description**

This instruction subtracts the contents of general register and the T bit from 0 and stores the result in Rn. A borrow resulting from the operation is reflected in the T bit. The NEGC instruction is used for sign inversion of a value exceeding 32 bits.

**Operation**

```

NEGC(long m, long n) /* NEGC Rm,Rn */
{
    unsigned long temp;

    temp=0-R[m];
    R[n]=temp-T;
    if (0<temp) T=1;
    else T=0;
    if (temp<R[n]) T=1;
    PC+=2;
}
    
```

**Example**

```

CLRT                ; Sign inversion of R0:R1 (64 bits)
NEGC  R1,R1         ; Before execution  R1 = H'00000001, T = 0
                   ; After execution   R1 = H'FFFFFFF, T = 1
NEGC  R0,R0         ; Before execution  R0 = H'00000000, T = 1
                   ; After execution   R0 = H'FFFFFFF, T = 1
    
```

**10.68 NOP      No OPeration      System Control Instruction**  
 No Operation

---

<b>Format</b>	<b>Summary of Operation</b>	<b>Instruction Code</b>	<b>Execution States</b>	<b>T Bit</b>
NOP	No operation	0000000000001001	1	—

**Description**

This instruction simply increments the program counter (PC), advancing the processing flow to execution of the next instruction.

**Operation**

```

NOP ( ) /* NOP */
{
    PC+=2;
}

```

**Example**

```

NOP ; Time equivalent to one execution state elapses.

```



**10.69 NOT**                      **NOT-logical complement**                      **Logical Instruction**  
 Bit Inversion

---

<b>Format</b>	<b>Summary of Operation</b>	<b>Instruction Code</b>	<b>Execution States</b>	<b>T Bit</b>
NOT Rm,Rn	~Rm → Rn	0110nnnnnnmmmm0111	1	—

**Description**

This instruction finds the one's complement of the contents of general register Rm and stores the result in Rn. That is, it inverts the Rm bits and stores the result in Rn.

**Operation**

```
NOT(long m, long n) /* NOT Rm,Rn */
{
    R[n]=~R[m];
    PC+=2;
}
```

**Example**

```
NOT R0,R1                      ; Before execution R0 = H'AAAAAAAA
                                 ; After execution R1 = H'55555555
```

**10.70 OCBI      Operand Cache Block  
Invalidate      Data Transfer Instruction**  
Cache Block Invalidation

---

<b>Format</b>	<b>Summary of Operation</b>	<b>Instruction Code</b>	<b>Execution States</b>	<b>T Bit</b>
OCBI @Rn	Operand cache block invalidation	0000nnnn10010011	1	—

---

**Description**

This instruction accesses data using the contents indicated by effective address Rn. In the case of a hit in the cache, the corresponding cache block is invalidated (the V bit is cleared to 0). If there is unwritten information (U bit = 1), write-back is not performed even if write-back mode is selected. No operation is performed in the case of a cache miss or an access to a non-cache area.

**Operation**

```
OCBI(int n)            /* OCBI @Rn */
{
  invalidate_operand_cache_block(R[n]);
  PC+=2;
}
```

**Possible Exceptions:**

- Data TLB miss exception
- Data TLB protection violation exception
- Initial page write exception
- Address error

Note that the above exceptions are generated even if OCBI does not operate.

## 10.71 OCBP Operand Cache Block Purge

## Data Transfer Instruction

Cache Block Purge

Format	Summary of Operation	Instruction Code	Execution States	T Bit
OCBP @Rn	Operand cache block purge	0000nnnn10100011	1	—

### Description

This instruction accesses data using the contents indicated by effective address Rn. If the cache is hit and there is unwritten information (U bit = 1), the corresponding cache block is written back to external memory and that block is invalidated (the V bit is cleared to 0). If there is no unwritten information (U bit = 0), the block is simply invalidated. No operation is performed in the case of a cache miss or an access to a non-cache area.

### Operation

```
OCBP(int n)          /* OCBP @Rn */
{
    if(is_dirty_block(R[n])) write_back(R[n])
    invalidate_operand_cache_block(R[n]);
    PC+=2;
}
```

### Possible Exceptions:

- Data TLB miss exception
- Data TLB protection violation exception
- Address error

Note that the above exceptions are generated even if OCBP does not operate.

## 10.72 OCBWB Operand Cache Block Write Back

## Data Transfer Instruction

Cache Block Write-Back

---

Format	Summary of Operation	Instruction Code	Execution States	T Bit
OCBWB @Rn	Operand cache block write-back	0000nnnn10110011	1	—

---

### Description

This instruction accesses data using the contents indicated by effective address Rn. If the cache is hit and there is unwritten information (U bit = 1), the corresponding cache block is written back to external memory and that block is cleaned (the U bit is cleared to 0). In other cases (i.e. in the case of a cache miss or an access to a non-cache area, or if the block is already clean), no operation is performed.

### Operation

```
OCBWB(int n)      /* OCBWB @Rn */
{
    if(is_dirty_block(R[n])) write_back(R[n]);
    PC+=2;
}
```

### Possible Exceptions:

- Data TLB miss exception
- Data TLB protection violation exception
- Address error

Note that the above exceptions are generated even if OCBWB does not operate.

## 10.73 OR

Logical OR

### OR logical

### Logical Instruction

---

Format	Summary of Operation	Instruction Code	Execution States	T Bit
OR Rm,Rn	Rn   Rm → Rn	0010nnnnmmmm1011	1	—
OR #imm,R0	R0   imm → R0	11001011iiiiiii	1	—
OR.B #imm,@(R0,GBR)	(R0+GBR)   imm → (R0+GBR)	11001111iiiiiii	4	—

---

#### Description

This instruction ORs the contents of general registers Rn and Rm and stores the result in Rn.

This instruction can be used to OR general register R0 contents with zero-extended 8-bit immediate data, or, in indexed GBR indirect addressing mode, to OR 8-bit memory with 8-bit immediate data.

## Operation

```
OR(long m, long n) /* OR Rm,Rn */
{
    R[n]|=R[m];
    PC+=2;
}

ORI(long i) /* OR #imm,R0 */
{
    R[0]|=(0x000000FF & (long)i);
    PC+=2;
}

ORM(long i) /* OR.B #imm,@(R0,GBR) */
{
    long temp;

    temp=(long)Read_Byte(GBR+R[0]);
    temp|=(0x000000FF & (long)i);
    Write_Byte(GBR+R[0],temp);
    PC+=2;
}
```

## Example

OR	R0,R1		; Before execution	R0 = H'AAAA5555, R1 = H'55550000
			; After execution	R1 = H'FFFF5555
OR	#H'F0,R0		; Before execution	R0 = H'00000008
			; After execution	R0 = H'000000F8
OR.B	#H'50,@(R0,GBR)		; Before execution	(R0,GBR) = H'A5
			; After execution	(R0,GBR) = H'F5

**10.74 PREF      PREFetch data to cache      Data Transfer Instruction**  
 Prefetch to Data  
 Cache

---

Format	Summary of Operation	Instruction Code	Execution States	T Bit
PREF @Rn	Prefetch cache block	0000nnnn10000011	1	—

**Description**

This instruction reads a 32-byte data block starting at a 32-byte boundary into the operand cache. The lower 5 bits of the address specified by Rn are masked to zero.

This instruction does not generate address-related errors. In the event of an error, the PREF instruction is treated as an NOP (no operation) instruction.

**Operation**

```
PREF(int n) /* PREF */
{
    PC+=2;
}
```

**Example**

```
MOV.L    #SOFT_PF,R1    ;R1 address is SOFT_PF
PREF     @R1            ;Load SOFT_PF data into on-chip cache

        .align 32
SOFT_PF: .data.l  H'12345678
        .data.l  H'9ABCDEF0
        .data.l  H'AAAA5555
        .data.l  H'5555AAAA
        .data.l  H'11111111
        .data.l  H'22222222
        .data.l  H'33333333
        .data.l  H'44444444
```

## 10.75 ROTCL ROTate with Carry Left Shift Instruction

One-Bit Left Rotation through T Bit

Format	Summary of Operation	Instruction Code	Execution States	T Bit
ROTCL Rn	$T \leftarrow Rn \leftarrow T$	0100nnnn00100100	1	MSB

### Description

This instruction rotates the contents of general register Rn one bit to the left through the T bit, and stores the result in Rn. The bit rotated out of the operand is transferred to the T bit.

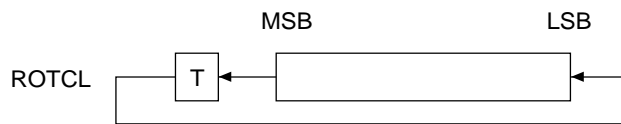

### Operation

```

ROTCL(long n) /* ROTCL Rn */
{
    long temp;

    if ((R[n]&0x80000000)==0) temp=0;
    else temp=1;
    R[n]<<=1;
    if (T==1) R[n]|=0x00000001;
    else R[n]&=0xFFFFFFFE;
    if (temp==1) T=1;
    else T=0;
    PC+=2;
}

```

### Example

```

ROTCL R0          ; Before execution R0 = H'80000000, T = 0
                  ; After execution  R0 = H'00000000, T = 1

```



## 10.76 ROTCR ROTate with Carry Right Shift Instruction

One-Bit Right Rotation through T Bit

Format	Summary of Operation	Instruction Code	Execution States	T Bit
ROTCR Rn	T → Rn → T	0100nnnn00100101	1	LSB

### Description

This instruction rotates the contents of general register Rn one bit to the right through the T bit, and stores the result in Rn. The bit rotated out of the operand is transferred to the T bit.

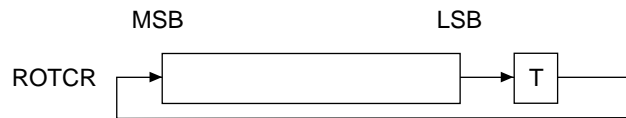

### Operation

```
ROTCR(long n) /* ROTCR Rn */
{
    long temp;

    if ((R[n]&0x00000001)==0) temp=0;
    else temp=1;
    R[n]>>=1;
    if (T==1) R[n]|=0x80000000;
    else R[n]&=0x7FFFFFFF;
    if (temp==1) T=1;
    else T=0;
    PC+=2;
}
```

### Example

```
ROTCR R0          ; Before execution R0 = H'00000001, T = 1
                  ; After execution  R0 = H'80000000, T = 1
```

**10.77 ROTL      ROTate Left**  
 One-Bit Left  
 Rotation

**Shift Instruction**

Format	Summary of Operation	Instruction Code	Execution States	T Bit
ROTL Rn	$T \leftarrow Rn \leftarrow \text{MSB}$	0100nnnn00000100	1	MSB

**Description**

This instruction rotates the contents of general register Rn one bit to the left, and stores the result in Rn. The bit rotated out of the operand is transferred to the T bit.

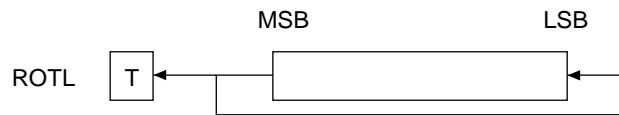

**Operation**

```

ROTL(long n) /* ROTL Rn */
{
    if ((R[n]&0x80000000)==0) T=0;
    else T=1;
    R[n]<<=1;
    if (T==1) R[n]|=0x00000001;
    else R[n]&=0xFFFFFFFF;
    PC+=2;
}

```

**Example**

```

ROTL R0          ; Before execution R0 = H'80000000, T = 0
                  ; After execution  R0 = H'00000001, T = 1

```

**10.78 ROTR ROTate Right**  
 One-Bit Right  
 Rotation

**Shift Instruction**

Format	Summary of Operation	Instruction Code	Execution States	T Bit
ROTR Rn	LSB → Rn → T	0100nnnn00000101	1	LSB

**Description**

This instruction rotates the contents of general register Rn one bit to the right, and stores the result in Rn. The bit rotated out of the operand is transferred to the T bit.

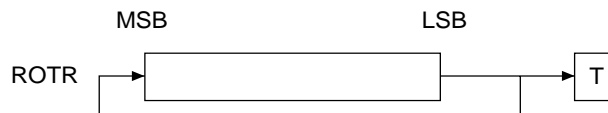

**Operation**

```
ROTR(long n) /* ROTR Rn */
{
    if ((R[n]&0x00000001)==0) T=0;
    else T=1;
    R[n]>>=1;
    if (T==1) R[n]|=0x80000000;
    else R[n]&=0x7FFFFFFF;
    PC+=2;
}
```

**Example**

```
ROTR R0 ; Before execution R0 = H'00000001, T = 0
        ; After execution R0 = H'80000000, T = 1
```

<b>10.79</b>	<b>RTE</b> Return from Exception Handling	<b>ReTurn from Exception</b>	<b>System Control Instruction</b> (Privileged Instruction) Delayed Branch Instruction
--------------	--	------------------------------	---

---

Format	Summary of Operation	Instruction Code	Execution States	T Bit
RTE	SSR → SR, SPC → PC	0000000000101011	5	—

**Description**

This instruction returns from an exception or interrupt handling routine by restoring the PC and SR values from SPC and SSR. Program execution continues from the address specified by the restored PC value.

RTE is a privileged instruction, and can only be used in privileged mode. Use of this instruction in user mode will cause an illegal instruction exception.

**Notes**

As this is a delayed branch instruction, the instruction following the RTE instruction is executed before the branch destination instruction.

Interrupts are not accepted between this instruction and the following instruction. An exception must not be generated by the instruction in this instruction's delay slot. If the following instruction is a branch instruction, it is identified as a slot illegal instruction.

If this instruction is located in the delay slot immediately following a delayed branch instruction, it is identified as a slot illegal instruction.

The SR value accessed by the instruction in the RTE delay slot is the value restored from SSR by the RTE instruction. The SR and MD values defined prior to RTE execution are used to fetch the instruction in the RTE delay slot.

## Operation

```
RTE( ) /* RTE */
{
    unsigned int temp;
    temp=PC;
    SR=SSR;
    PC=SPC;
    Delay_Slot(temp+2);
}
```

## Example

```
RTE                ; Return to original routine.
ADD    #8, R14     ; Executed before branch.
```

Note: In a delayed branch, the actual branch operation occurs after execution of the slot instruction, but instruction execution (register updating, etc.) is in fact performed in delayed branch instruction → delay slot instruction order. For example, even if the register holding the branch destination address is modified in the delay slot, the branch destination address will still be the register contents prior to the modification.

## 10.80 RTS

## ReTurn from Subroutine

## Branch Instruction

Return from Subroutine Procedure

Delayed Branch Instruction

Format	Summary of Operation	Instruction Code	Execution States	T Bit
RTS	PR → PC	0000000000001011	2	—

### Description

This instruction returns from a subroutine procedure by restoring the PC from PR. Processing continues from the address indicated by the restored PC value. This instruction can be used to return from a subroutine procedure called by a BSR or JSR instruction to the source of the call.

### Notes

As this is a delayed branch instruction, the instruction following this instruction is executed before the branch destination instruction.

Interrupts are not accepted between this instruction and the following instruction. If the following instruction is a branch instruction, it is identified as a slot illegal instruction.

The instruction that restores PR must be executed before the RTS instruction. This restore instruction cannot be in the RTS delay slot.

### Operation

```
RTS( ) /* RTS */
{
    unsigned int temp;

    temp=PC;
    PC=PR;
    Delay_Slot(temp+2);
}
```

## Example

```
MOV.L    TABLE, R3    ; R3 = TRGET address
JSR      @R3           ; Branch to TRGET.
NOP                               ; NOP executed before branch.
ADD      R0, R1        ; ← Subroutine procedure return destination (PR contents)
.....
TABLE:   .data.l      TRGET    ; Jump table
.....
TRGET:   MOV          R1, R0    ; ← Entry to procedure
RTS                               ; PR contents → PC
MOV      #12, R0       ; MOV executed before branch.
```

**10.81 SETS**      **SET S bit**  
S Bit Setting

**System Control Instruction**

---

<b>Format</b>	<b>Summary of Operation</b>	<b>Instruction Code</b>	<b>Execution States</b>	<b>T Bit</b>
SETS	1 → S	0000000001011000	1	—

---

**Description**

This instruction sets the S bit to 1.

**Operation**

```
SETS( ) /* SETS */  
{  
    S=1;  
    PC+=2;  
}
```

**Example**

```
SETS                   ; Before execution S = 0  
                         ; After execution S = 1
```



## 10.82 SETT      SET T bit

T Bit Setting

## System Control Instruction

---

Format	Summary of Operation	Instruction Code	Execution States	T Bit
SETT	1 → T	0000000000011000	1	1

---

### Description

This instruction sets the T bit to 1.

### Operation

```
SETT( ) /* SETT */  
{  
    T=1;  
    PC+=2;  
}
```

### Example

```
SETT                    ; Before execution T = 0  
                         ; After execution T = 1
```

**10.83 SHAD**      **SHift Arithmetic Dynamically**      **Shift Instruction**  
 Dynamic Arithmetic Shift

Format	Summary of Operation	Instruction Code	Execution States	T Bit
SHAD Rm, Rn	When $Rm \geq 0$ , $Rn \ll Rm \rightarrow Rn$  When $Rm < 0$ , $Rn \gg Rm \rightarrow [MSB \rightarrow Rn]$	0100nnnnnnmmmm1100	1	—

**Description**

This instruction arithmetically shifts the contents of general register Rn. General register Rm specifies the shift direction and the number of bits to be shifted.

Rn register contents are shifted to the left if the Rm register value is positive, and to the right if negative. In a shift to the right, the MSB is added at the upper end.

The number of bits to be shifted is specified by the lower 5 bits (bits 4 to 0) of the Rm register. If the value is negative (MSB = 1), the Rm register is represented as a two's complement. The left shift range is 0 to 31, and the right shift range, 1 to 32.

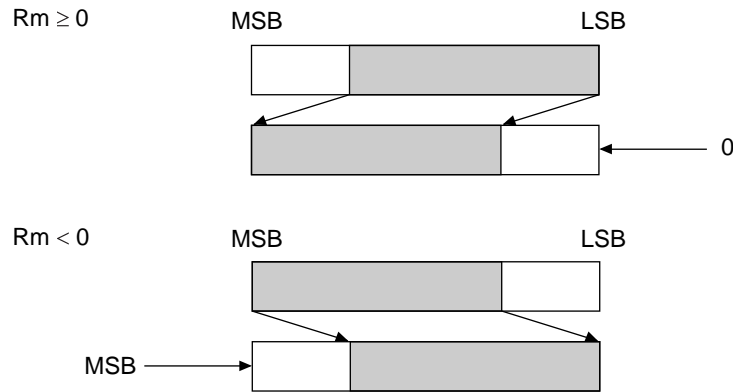

## Operation

```
SHAD(int m,n) /*SHAD Rm,Rn */
{
    int sgn=R[m] & 0x80000000;
    if (sgn==0)
        R[n] <<= (R[m] & 0x1F);
    else if ((R[m] & 0x1F) == 0) {
        if ((R[n] & 0x80000000) == 0)
            R[n] = 0;
        else
            R[n] = 0xFFFFFFFF;
    }
    else
        R[n]=(long)R[n] >> ((~R[m] & 0x1F)+1);
    PC+=2;
}
```

## Example

SHAD	R1,R2	; Before execution	R1 = H'FFFFFFEC, R2 = H'80180000
		; After execution	R1 = H'FFFFFFEC, R2 = H'FFFFF801
SHAD	R3,R4	; Before execution	R3 = H'00000014, R4 = H'FFFFF801
		; After execution	R3 = H'00000014, R4 = H'80100000

**10.84 SHAL SHift Arithmetic Left Shift Instruction**  
 One-Bit Left  
 Arithmetic Shift

Format	Summary of Operation	Instruction Code	Execution States	T Bit
SHAL Rn	$T \leftarrow Rn \leftarrow 0$	0100nnnn00100000	1	MSB

**Description**

This instruction arithmetically shifts the contents of general register Rn one bit to the left, and stores the result in Rn. The bit shifted out of the operand is transferred to the T bit.

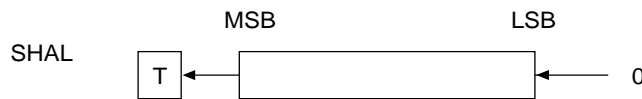

**Operation**

```
SHAL(long n) /* SHAL Rn (Same as SHLL) */
{
    if ((R[n]&0x80000000)==0) T=0;
    else T=1;
    R[n]<<=1;
    PC+=2;
}
```

**Example**

```
SHAL R0 ; Before execution R0 = H'80000001, T = 0
; After execution R0 = H'00000002, T = 1
```

**10.85 SHAR SHift Arithmetic Right Shift Instruction**  
 One-Bit Right  
 Arithmetic Shift

Format	Summary of Operation	Instruction Code	Execution States	T Bit
SHAR Rn	MSB → Rn → T	0100nnnn00100001	1	LSB

**Description**

This instruction arithmetically shifts the contents of general register Rn one bit to the right, and stores the result in Rn. The bit shifted out of the operand is transferred to the T bit.

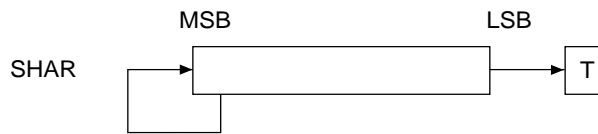

**Operation**

```
SHAR(long n) /* SHAR Rn */
{
    long temp;

    if ((R[n]&0x00000001)==0) T=0;
    else T=1;
    if ((R[n]&0x80000000)==0) temp=0;
    else temp=1;
    R[n]>>=1;
    if (temp==1) R[n]|=0x80000000;
    else R[n]&=0x7FFFFFFF;
    PC+=2;
}
```

**Example**

```
SHAR R0 ; Before execution R0 = H'80000001, T = 0
        ; After execution R0 = H'C0000000, T = 1
```

**10.86 SHLD SHift Logical Dynamically Shift Instruction**  
 Dynamic Logical Shift

Format	Summary of Operation	Instruction Code	Execution States	T Bit
SHLD Rm, Rn	When $Rm \geq 0$ , $Rn \ll Rm \rightarrow Rn$ When $Rm < 0$ , $Rn \gg Rm \rightarrow [0 \rightarrow Rn]$	0100nnnnmmmm1101	1	—

**Description**

This instruction logically shifts the contents of general register Rn. General register Rm specifies the shift direction and the number of bits to be shifted.

Rn register contents are shifted to the left if the Rm register value is positive, and to the right if negative. In a shift to the right, 0s are added at the upper end.

The number of bits to be shifted is specified by the lower 5 bits (bits 4 to 0) of the Rm register. If the value is negative (MSB = 1), the Rm register is represented as a two's complement. The left shift range is 0 to 31, and the right shift range, 1 to 32.

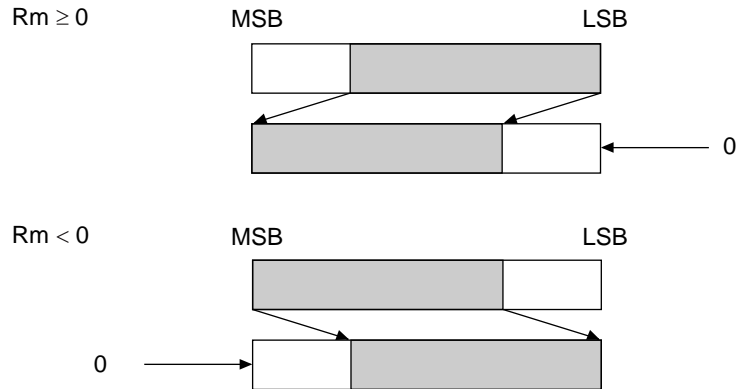

## Operation

```
SHLD(int m,n)/*SHLD Rm,Rn */
{
    int sgn = R[m] & 0x80000000;
    if (sgn == 0)
        R[n] <<= (R[m] & 0x1F);
    else if ((R[m] & 0x1F) == 0)
        R[n] = 0;
    else
        R[n]=(unsigned)R[n] >> ((~R[m] & 0x1F)+1);
    PC+=2;
}
```

## Example

```
SHLD  R1, R2      ; Before execution R1 = H'FFFFFFEC, R2 = H'80180000
                          ; After execution R1 = H'FFFFFFEC, R2 = H'00000801
SHLD  R3, R4      ; Before execution R3 = H'00000014, R4 = H'FFFFFF801
                          ; After execution R3 = H'00000014, R4 = H'80100000
```

**10.87 SHLL SHift Logical Left Shift Instruction**  
 One-Bit Left Logical Shift

Format	Summary of Operation	Instruction Code	Execution States	T Bit
SHLL Rn	$T \leftarrow Rn \ll 0$	0100nnnn00000000	1	MSB

**Description**

This instruction logically shifts the contents of general register Rn one bit to the left, and stores the result in Rn. The bit shifted out of the operand is transferred to the T bit.

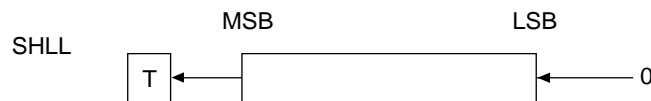

**Operation**

```
SHLL(long n) /* SHLL Rn (Same as SHAL) */
{
  if ((R[n]&0x80000000)==0) T=0;
  else T=1;
  R[n]<<=1;
  PC+=2;
}
```

**Example**

```
SHLL R0 ; Before execution R0 = H'80000001, T = 0
; After execution R0 = H'00000002, T = 1
```



**10.88 SHLLn**      **n bits SHift Logical Left**      **Shift Instruction**  
n-Bit Left  
Logical Shift

Format	Summary of Operation	Instruction Code	Execution States	T Bit
SHLL2 Rn	$Rn \ll 2 \rightarrow Rn$	0100nnnn00001000	1	—
SHLL8 Rn	$Rn \ll 8 \rightarrow Rn$	0100nnnn00011000	1	—
SHLL16 Rn	$Rn \ll 16 \rightarrow Rn$	0100nnnn00101000	1	—

**Description**

This instruction logically shifts the contents of general register Rn 2, 8, or 16 bits to the left, and stores the result in Rn. The bits shifted out of the operand are discarded.

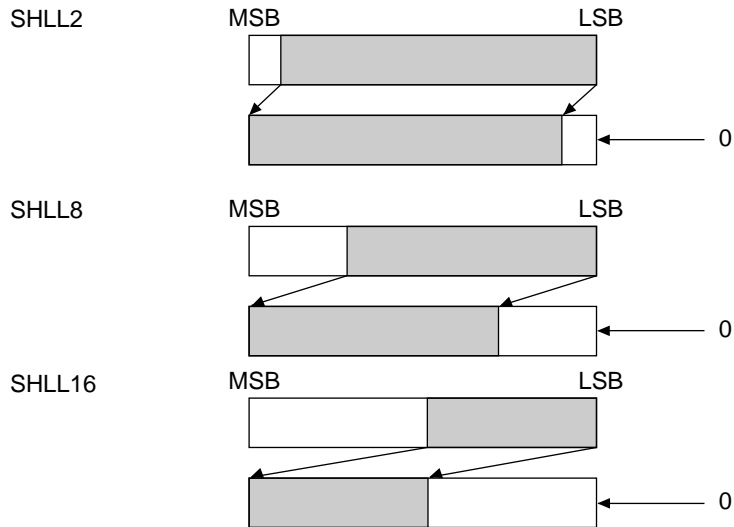

## Operation

```
SHLL2(long n) /* SHLL2 Rn */  
{  
    R[n]<<=2;  
    PC+=2;  
}
```

```
SHLL8(long n) /* SHLL8 Rn */  
{  
    R[n]<<=8;  
    PC+=2;  
}
```

```
SHLL16(long n) /* SHLL16 Rn */  
{  
    R[n]<<=16;  
    PC+=2;  
}
```

## Example

```
SHLL2   R0           ; Before execution R0 = H'12345678  
                       ; After execution  R0 = H'48D159E0  
SHLL8   R0           ; Before execution R0 = H'12345678  
                       ; After execution  R0 = H'34567800  
SHLL16  R0           ; Before execution R0 = H'12345678  
                       ; After execution  R0 = H'56780000
```

**10.89 SHLR SHift Logical Right Shift Instruction**  
 One-Bit Right Logical Shift

Format	Summary of Operation	Instruction Code	Execution States	T Bit
SHLR Rn	0 → Rn → T	0100n000000001	1	LSB

**Description**

This instruction logically shifts the contents of general register Rn one bit to the right, and stores the result in Rn. The bit shifted out of the operand is transferred to the T bit.

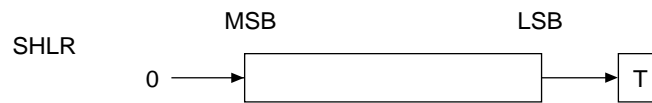

**Operation**

```
SHLR(long n) /* SHLR Rn */
{
  if ((R[n]&0x00000001)==0) T=0;
  else T=1;
  R[n]>>=1;
  R[n]&=0x7FFFFFFF;
  PC+=2;
}
```

**Example**

```
SHLR R0 ; Before execution R0 = H'80000001, T = 0
        ; After execution R0 = H'40000000, T = 1
```

**10.90 SHLRn**      **n bits SHift Logical Right**      **Shift Instruction**  
n-Bit Right  
Logical Shift

Format	Summary of Operation	Instruction Code	Execution States	T Bit
SHLR2 Rn	$Rn \gg 2 \rightarrow Rn$	0100nnnn00001001	1	—
SHLR8 Rn	$Rn \gg 8 \rightarrow Rn$	0100nnnn00011001	1	—
SHLR16 Rn	$Rn \gg 16 \rightarrow Rn$	0100nnnn00101001	1	—

**Description**

This instruction logically shifts the contents of general register Rn 2, 8, or 16 bits to the right, and stores the result in Rn. The bits shifted out of the operand are discarded.

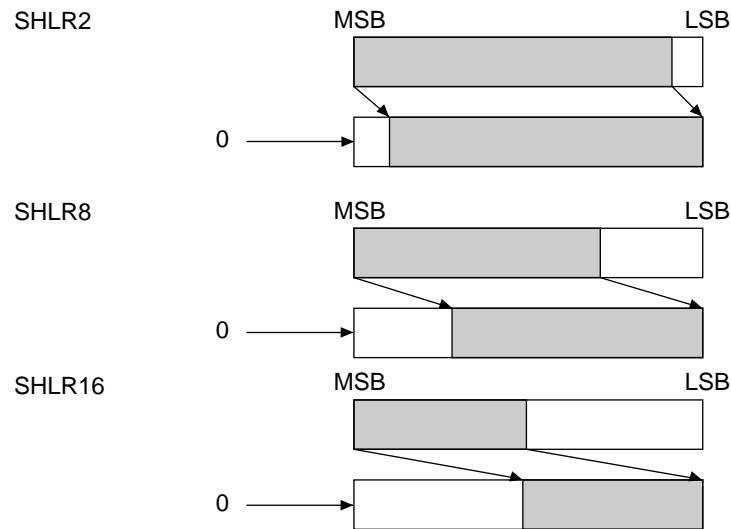

## Operation

```
SHLR2(long n)          /* SHLR2 Rn */
{
    R[n]>>=2;
    R[n]&=0x3FFFFFFF;
    PC+=2;
}
```

```
SHLR8(long n)          /* SHLR8 Rn */
{
    R[n]>>=8;
    R[n]&=0x0FFFFFFF;
    PC+=2;
}
```

```
SHLR16(long n)         /* SHLR16 Rn */
{
    R[n]>>=16;
    R[n]&=0x0000FFFF;
    PC+=2;
}
```

## Example

```
SHLR2   R0           ; Before execution R0 = H'12345678
                          ; After execution R0 = H'048D159E
SHLR8   R0           ; Before execution R0 = H'12345678
                          ; After execution R0 = H'00123456
SHLR16  R0           ; Before execution R0 = H'12345678
                          ; After execution R0 = H'00001234
```

## 10.91 SLEEP SLEEP

Transition to Power-Down Mode

## System Control Instruction

(Privileged Instruction)

---

Format	Summary of Operation	Instruction Code	Execution States	T Bit
SLEEP	Sleep	0000000000011011	4	—

---

### Description

This instruction places the CPU in the power-down state.

In power-down mode, the CPU retains its internal state, but immediately stops executing instructions and waits for an interrupt request. When it receives an interrupt request, the CPU exits the power-down state.

SLEEP is a privileged instruction, and can only be used in privileged mode. Use of this instruction in user mode will cause an illegal instruction exception.

### Notes

SLEEP performance depends on the standby control register (STBCR). See section 9, Power-Down Modes, for details.

### Operation

```
SLEEP( ) /* SLEEP */
{
    Sleep_standby();
}
```

### Example

```
SLEEP ;Transition to power-down mode
```

**10.92 STC****Store Control register****System Control Instruction**

Store from Control Register

(Privileged Instruction)

Format	Summary of Operation	Instruction Code	Execution States	T Bit	
STC	SR, Rn	SR → Rn	0000nnnn00000010	2	—
STC	GBR, Rn	GBR → Rn	0000nnnn00010010	2	—
STC	VBR, Rn	VBR → Rn	0000nnnn00100010	2	—
STC	SSR, Rn	SSR → Rn	0000nnnn00110010	2	—
STC	SPC, Rn	SPC → Rn	0000nnnn01000010	2	—
STC	SGR, Rn	SGR → Rn	0000nnnn00111010	3	—
STC	DBR, Rn	DBR → Rn	0000nnnn11111010	2	—
STC	R0_BANK, Rn	R0_BANK → Rn	0000nnnn10000010	2	—
STC	R1_BANK, Rn	R1_BANK → Rn	0000nnnn10010010	2	—
STC	R2_BANK, Rn	R2_BANK → Rn	0000nnnn10100010	2	—
STC	R3_BANK, Rn	R3_BANK → Rn	0000nnnn10110010	2	—
STC	R4_BANK, Rn	R4_BANK → Rn	0000nnnn11000010	2	—
STC	R5_BANK, Rn	R5_BANK → Rn	0000nnnn11010010	2	—
STC	R6_BANK, Rn	R6_BANK → Rn	0000nnnn11100010	2	—
STC	R7_BANK, Rn	R7_BANK → Rn	0000nnnn11110010	2	—
STC.L	SR, @-Rn	Rn-4 → Rn, SR → (Rn)	0100nnnn00000011	2	—
STC.L	GBR, @-Rn	Rn-4 → Rn, GBR → (Rn)	0100nnnn00010011	2	—
STC.L	VBR, @-Rn	Rn-4 → Rn, VBR → (Rn)	0100nnnn00100011	2	—
STC.L	SSR, @-Rn	Rn-4 → Rn, SSR → (Rn)	0100nnnn00110011	2	—
STC.L	SPC, @-Rn	Rn-4 → Rn, SPC → (Rn)	0100nnnn01000011	2	—
STC.L	SGR, @-Rn	Rn-4 → Rn, SGR → (Rn)	0100nnnn00110010	3	—
STC.L	DBR, @-Rn	Rn-4 → Rn, DBR → (Rn)	0100nnnn11110010	2	—
STC.L	R0_BANK, @-Rn	Rn-4 → Rn, R0_BANK → (Rn)	0100nnnn10000011	2	—
STC.L	R1_BANK, @-Rn	Rn-4 → Rn, R1_BANK → (Rn)	0100nnnn10010011	2	—
STC.L	R2_BANK, @-Rn	Rn-4 → Rn, R2_BANK → (Rn)	0100nnnn10100011	2	—
STC.L	R3_BANK, @-Rn	Rn-4 → Rn, R3_BANK → (Rn)	0100nnnn10110011	2	—
STC.L	R4_BANK, @-Rn	Rn-4 → Rn, R4_BANK → (Rn)	0100nnnn11000011	2	—
STC.L	R5_BANK, @-Rn	Rn-4 → Rn, R5_BANK → (Rn)	0100nnnn11010011	2	—
STC.L	R6_BANK, @-Rn	Rn-4 → Rn, R6_BANK → (Rn)	0100nnnn11100011	2	—
STC.L	R7_BANK, @-Rn	Rn-4 → Rn, R7_BANK → (Rn)	0100nnnn11110011	2	—

## Description

This instruction stores control register SR, GBR, VBR, SSR, SPC, SGR, DBR or Rm\_BANK (m = 0–7) in the destination.

Rm\_BANK operands are specified by the RB bit of the SR register:  
when the RB bit is 1 Rm\_BANK0 is accessed,  
when the RB bit is 0 Rm\_BANK1 is accessed.

## Notes

STC/STC.L can only be used in privileged mode excepting STC GBR, Rn/STC.L GBR, @-Rn.  
Use of these instructions in user mode will cause illegal instruction exceptions.

## Operation

```
STCSR(int n)      /* STC SR,Rn : Privileged */
{
    R[n]=SR;
    PC+=2;
}
```

```
STCGBR(int n)     /* STC GBR,Rn */
{
    R[n]=SGR;
    PC+=2;
}
```

```
STCVBR(int n)     /* STC VBR,Rn : Privileged */
{
    R[n]=VBR;
    PC+=2;
}
```

```
STCSSR(int n)     /* STC SSR,Rn : Privileged */
{
    R[n]=SSR;
    PC+=2;
}
```



```

STCSPC(int n)      /* STC SPC,Rn : Privileged */
{
    R[n]=SPC;
    PC+=2;
}

STCSGR(int n)      /* STC SGR,Rn : Privileged */
{
    R[n]=SGR;
    PC+=2;
}

STCDBR(int n)      /* STC DBR,Rn : Privileged */
{
    R[n]=DBR;
    PC+=2;
}

STCRm_BANK(int n)  /* STC Rm_BANK,Rn : Privileged */
                    /* m=0-7 */
{
    R[n]=Rm_BANK;
    PC+=2;
}

STCMSR(int n)      /* STC.L SR,@-Rn : Privileged */
{
    R[n]-=4;
    Write_Long(R[n],SR);
    PC+=2;
}

STCMGBR(int n)     /* STC.L GBR,@-Rn */
{
    R[n]-=4;
    Write_Long(R[n],GBR);
    PC+=2;
}

```

```

    }

STCMVBR(int n)      /* STC.L VBR,@-Rn : Privileged */
{
    R[n]-=4;
    Write_Long(R[n],VBR);
    PC+=2;
}

STCMSSR(int n)     /* STC.L SSR,@-Rn : Privileged */
{
    R[n]-=4;
    Write_Long(R[n],SSR);
    PC+=2;
}

STCMSPC(int n)     /* STC.L SPC,@-Rn : Privileged */
{
    R[n]-=4;
    Write_Long(R[n],SPC);
    PC+=2;
}

STCMSGR(int n)     /* STC.L SGR,@-Rn : Privileged */
{
    R[n]-=4;
    Write_Long(R[n],SGR);
    PC+=2;
}

STCMDDBR(int n)    /* STC.L DBR,@-Rn : Privileged */
{
    R[n]-=4;
    Write_Long(R[n],DBR);
    PC+=2;
}

```

```
STCMRm_BANK(int n)      /* STC.L Rm_BANK,@-Rn : Privileged */
                          /* m=0-7 */
{
    R[n]-=4;
    Write_Long(R[n],Rm_BANK);
    PC+=2;
}
```

**Possible Exceptions:**

- General illegal instruction exception
- Slot illegal instruction exception
- Data TLB miss exception
- Data TLB protection violation exception
- Address error

**10.93 STS                      STore System register                      System Control Instruction**  
 Store from  
 System Register

---

<b>Format</b>	<b>Summary of Operation</b>	<b>Instruction Code</b>	<b>Execution States</b>	<b>T Bit</b>
STS MACH,Rn	MACH → Rn	0000nnnn00001010	1	—
STS MACL,Rn	MACL → Rn	0000nnnn00011010	1	—
STS PR,Rn	PR → Rn	0000nnnn00101010	1	—
STS.L MACH,@-Rn	Rn-4 → Rn, MACH → (Rn)	0100nnnn00000010	1	—
STS.L MACL,@-Rn	Rn-4 → Rn, MACL → (Rn)	0100nnnn00010010	1	—
STS.L PR,@-Rn	Rn-4 → Rn, PR → (Rn)	0100nnnn00100010	1	—

**Description**

This instruction stores system register MACH, MACL, or PR in the destination.

**Operation**

```
STSMACH(int n)        /* STS MACH,Rn */
{
  R[n]=MACH;
  PC+=2;
}
```

```
STSMACL(int n)        /* STS MACL,Rn */
{
  R[n]=MACL;
  PC+=2;
}
```

```
STSPR(int n)         /* STS PR,Rn */
{
  R[n]=PR;
  PC+=2;
}
```

```
STSMACH(int n)        /* STS.L MACH,@-Rn */
{
```

```

R[n]--=4;
Write_Long(R[n],MACH);
PC+=2;
}

STSMACL(int n) /* STS.L MACL,@-Rn */
{
R[n]--=4;
Write_Long(R[n],MACL);
PC+=2;
}

STSMR(int n) /* STS.L PR,@-Rn */
{
R[n]--=4;
Write_Long(R[n],PR);
PC+=2;
}

```

#### Possible Exceptions:

- Data TLB miss exception
- Data TLB protection violation exception
- Address error

#### Example

```

STS MACH,R0 ; Before execution R0 = H'FFFFFFFF, MACH = H'00000000
; After execution R0 = H'00000000
STS.L PR,@-R15 ; Before execution R15 = H'10000004
; After execution R15 = H'10000000, (R15) = PR

```

## 10.94 STS

### Store from FPU System register

### System Control Instruction

Store from FPU  
System Register

Format	Summary of Operation	Instruction Code	Execution States	T Bit
STS FPUL,Rn	FPUL → Rn	0000nnnn01011010	1	—
STS FPSCR,Rn	FPSCR → Rn	0000nnnn01101010	1	—
STS.L FPUL,@-Rn	Rn-4 → Rn, FPUL → (Rn)	0100nnnn01010010	1	—
STS.L FPSCR,@-Rn	Rn-4 → Rn, FPSCR → (Rn)	0100nnnn01100010	1	—

#### Description

This instruction stores FPU system register FPUL or FPSCR in the destination.

#### Operation

```
STS(int n, int *FPUL)          /* STS FPUL,Rn */
{
    R[n]= *FPUL;
    PC+=2;
}
STS_SAVE(int n, int *FPUL)     /* STS.L FPUL,@-Rn */
{
    R[n]-=4;
    Write_Long(R[n],*FPUL) ;
    PC+=2;
}
STS(int n)                     /* STS FPSCR,Rn */
{
    R[n]=FPSCR&0x003FFFFFF;
    PC+=2;
}
STS_RESTORE(int n)            /* STS.L FPSCR,@-Rn */
{
    R[n]-=4;
    Write_Long(R[n],FPSCR&0x003FFFFFF)
```

```

        PC+=2;
    }

```

#### Possible Exceptions:

- Data TLB miss exception
- Data TLB protection violation exception
- Address error

#### Examples

- STS

Example 1:

```

MOV.L  #H'12ABCDEF, R12
LDS    R12, FPUL
STS    FPUL, R13

```

; After executing the STS instruction:

; R13 = 12ABCDEF

Example 2:

```

STS    FPSCR, R2

```

; After executing the STS instruction:

; The current content of FPSCR is stored in register R2

- STS.L

Example 1:

```

MOV.L  #H'0C700148, R7
STS.L  FPUL, @-R7

```

; Before executing the STS.L instruction:

; R7 = 0C700148

; After executing the STS.L instruction:

; R7 = 0C700144, and the content of FPUL is saved at memory

; location 0C700144.

Example 2:

```

MOV.L  #H'0C700154, R8
STS.L  FPSCR, @-R8

```

; After executing the STS.L instruction:

; The content of FPSCR is saved at memory location 0C700150.

## 10.95 SUB SUBtract binary

Binary Subtraction

## Arithmetic Instruction

---

Format	Summary of Operation	Instruction Code	Execution States	T Bit
SUB Rm,Rn	Rn-Rm → Rn	0011nnnnnnmmmm1000	1	—

---

### Description

This instruction subtracts the contents of general register Rm from the contents of general register Rn and stores the result in Rn. For immediate data subtraction, ADD #imm,Rn should be used.

### Operation

```
SUB(long m, long n) /* SUB Rm,Rn */
{
    R[n]-=R[m];
    PC+=2;
}
```

### Example

```
SUB    R0,R1          ; Before execution  R0 = H'00000001, R1 = H'80000000
                          ; After execution  R1 = H'7FFFFFFF
```



**10.96 SUBC SUBtract with Carry**  
Binary Subtraction with Borrow

**Arithmetic Instruction**

Format	Summary of Operation	Instruction Code	Execution States	T Bit
SUBC Rm,Rn	Rn-Rm-T → Rn, borrow → T	0011nnnnnnmmmm1010	1	Borrow

**Description**

This instruction subtracts the contents of general register Rm and the T bit from the contents of general register Rn, and stores the result in Rn. A borrow resulting from the operation is reflected in the T bit. This instruction is used for subtractions exceeding 32 bits.

**Operation**

```

SUBC(long m, long n) /* SUBC Rm,Rn */
{
    unsigned long tmp0,tmp1;

    tmp1=R[n]-R[m];
    tmp0=R[n];
    R[n]=tmp1-T;
    if (tmp0<tmp1) T=1;
    else T=0;
    if (tmp1<R[n]) T=1;
    PC+=2;
}

```

**Example**

```

CLRT                ; R0:R1(64 bits) – R2:R3(64 bits) = R0:R1(64 bits)
SUBC  R3 ,R1        ; Before execution  T = 0, R1 = H'00000000, R3 = H'00000001
                   ; After execution   T = 1, R1 = H'FFFFFFF
SUBC  R2 ,R0        ; Before execution  T = 1, R0 = H'00000000, R2 = H'00000000
                   ; After execution   T = 1, R0 = H'FFFFFFF

```

## 10.97 SUBV SUBtract with (V flag) underflow check

## Arithmetic Instruction

Binary Subtraction  
with Underflow Check

Format	Summary of Operation	Instruction Code	Execution States	T Bit
SUBV Rm,Rn	Rn-Rm → Rn, underflow → T	0011nnnnmmmm1011	1	Underflow

### Description

This instruction subtracts the contents of general register Rm from the contents of general register Rn, and stores the result in Rn. If underflow occurs, the T bit is set.

### Operation

```
SUBV(long m, long n) /* SUBV Rm,Rn */
{
    long dest,src,ans;

    if ((long)R[n]>=0) dest=0;
    else dest=1;
    if ((long)R[m]>=0) src=0;
    else src=1;
    src+=dest;
    R[n]-=R[m];
    if ((long)R[n]>=0) ans=0;
    else ans=1;
    ans+=dest;
    if (src==1) {
        if (ans==1) T=1;
        else T=0;
    }
    else T=0;
    PC+=2;
}
```

### Example

```
SUBV  R0 , R1      ; Before execution  R0 = H'00000002, R1 = H'80000001
                          ; After execution  R1 = H'7FFFFFFF, T = 1
SUBV  R2 , R3      ; Before execution  R2 = H'FFFFFFFE, R3 = H'7FFFFFFE
                          ; After execution  R3 = H'80000000, T = 1
```

**10.98 SWAP SWAP register halves Data Transfer Instruction**  
 Upper-/Lower-Half  
 Swap

Format	Summary of Operation	Instruction Code	Execution States	T Bit
SWAP.B Rm,Rn	Rm → lower-2-byte upper-/lower-byte swap → Rn	0110nnnnmmmm1000	1	—
SWAP.W Rm,Rn	Rm → upper-/lower-word swap → Rn	0110nnnnmmmm1001	1	

**Description**

This instruction swaps the upper and lower parts of the contents of general register Rm, and stores the result in Rn.

In the case of a byte specification, the 8 bits from bit 15 to bit 8 of Rm are swapped with the 8 bits from bit 7 to bit 0. The upper 16 bits of Rm are transferred directly to the upper 16 bits of Rn.

In the case of a word specification, the 16 bits from bit 31 to bit 16 of Rm are swapped with the 16 bits from bit 15 to bit 0.

**Operation**

```
SWAPB(long m, long n)      /* SWAP.B Rm,Rn */
{
    unsigned long temp0,temp1;

    temp0=R[m]&0xFFFF0000;
    temp1=(R[m]&0x000000FF)<<8;
    R[n]=(R[m]&0x0000FF00)>>8;
    R[n]=R[n]|temp1|temp0;
    PC+=2;
}
```

```
SWAPW(long m, long n)      /* SWAP.W Rm,Rn */
{
    unsigned long temp;

    temp=(R[m]>>16)&0x0000FFFF;
    R[n]=R[m]<<16;
```

```
R[n] |= temp;  
PC += 2;  
}
```

### Example

```
SWAP.B R0,R1 ; Before execution R0 = H'12345678  
; After execution R1 = H'12347856  
SWAP.W R0,R1 ; Before execution R0 = H'12345678  
; After execution R1 = H'56781234
```

**10.99 TAS Test And Set**  
Memory Test  
and Bit Setting

**Logical Instruction**

Format	Summary of Operation	Instruction Code	Execution States	T Bit
TAS.B @Rn	If (Rn) = 0, 1 → T, else 0 → T 1 → MSB of (Rn)	0100nnnn00011011	5	Test result

**Description**

This instruction purges the cache block corresponding to the memory area specified by the contents of general register Rn, reads the byte data indicated by that address, and sets the T bit to 1 if that data is zero, or clears the T bit to 0 if the data is nonzero. The instruction then sets bit 7 to 1 and writes to the same address. The bus is not released during this period.

The purge operation is executed as follows.

In a purge operation, data is accessed using the contents of general register Rn as the effective address. If there is a cache hit and the corresponding cache block is dirty (U bit = 1), the contents of that cache block are written back to external memory, and the cache block is then invalidated (by clearing the V bit to 0). If there is a cache hit and the corresponding cache block is clean (U bit = 0), the cache block is simply invalidated (by clearing the V bit to 0). A purge is not executed in the event of a cache miss, or if the accessed memory location is non-cacheable.

The two TAS.B memory accesses are executed automatically. Another memory access is not executed between the two TAS.B accesses.

**Operation**

```
TAS(int n) /* TAS.B @Rn */
{
    int temp;

    temp=(int)Read_Byte(R[n]); /* Bus Lock */
    if (temp==0) T=1;
    else T=0;
    temp|=0x00000080;
    Write_Byte(R[n],temp); /* Bus unlock */
    PC+=2;
}
```

**Possible Exceptions:**

- Data TLB miss exception
- Data TLB protection violation exception
- Initial page write exception
- Address error

Exceptions are checked taking a data access by this instruction as a byte store.

**10.100 TRAPA TRAP Always**  
 Trap Exception  
 Handling

**System Control Instruction**

Format	Summary of Operation	Instruction Code	Execution States	T Bit
TRAPA #imm	imm → TRA, PC+2 → SPC, SR → SSR, 1 → SR.MD/ BL/RB, 0x160 → EXPEVT, VBR+H'00000100 → PC	11000011iiiiiiii	7	—

**Description**

This instruction starts trap exception handling. The values of (PC + 2) and SR are saved to SPC and SSR, and 8-bit immediate data is stored in the TRA register (bits 9 to 2). The processor mode is switched to privileged mode (the MD bit in SR is set to 1), and the BL bit and RB bit in SR are set to 1. As a result, exception and interrupt requests are masked (not accepted), and the BANK1 registers (R0\_BANK1 to R7\_BANK1) are selected. Exception code 0x160 is written to the EXPEVT register (bits 11 to 0). The program branches to address (VBR + H'00000100), indicated by the sum of the VBR register contents and offset H'00000100.

**Operation**

```
TRAPA(int i) /* TRAPA #imm */
{
  int imm;

  imm=(0x000000FF & i);
  TRA=imm<<2;
  SSR=SR;
  SPC=PC+2;
  SR.MD=1;
  SR.BL=1;
  SR.RB=1;
  EXPEVT=0x00000160;
  PC=VBR+H'00000100;
}
```



**10.101 TST****TeST logical****Logical Instruction**

AND Operation  
T Bit Setting

Format	Summary of Operation	Instruction Code	Execution States	T Bit
TST Rm,Rn	Rn & Rm; if result is 0, 1 → T, else 0 → T	0010nnnnmmmm1000	1	Test result
TST #imm,R0	R0 & imm; if result is 0, 1 → T, else 0 → T	11001000iiiiiii	1	Test result
TST.B #imm,@(R0,GBR)	(R0 + GBR) & imm; if result is 0, 1 → T, else 0 → T	11001100iiiiiii	3	Test result

**Description**

This instruction ANDs the contents of general registers Rn and Rm, and sets the T bit if the result is zero. If the result is nonzero, the T bit is cleared. The contents of Rn are not changed.

This instruction can be used to AND general register R0 contents with zero-extended 8-bit immediate data, or, in indexed GBR indirect addressing mode, to AND 8-bit memory with 8-bit immediate data. The contents of R0 or the memory are not changed.

**Operation**

```
TST(long m, long n) /* TST Rm,Rn */
{
    if ((R[n]&R[m])==0) T=1;
    else T=0;
    PC+=2;
}

TSTI(long i) /* TST #imm,R0 */
{
    long temp;

    temp=R[0]&(0x000000FF & (long)i);
    if (temp==0) T=1;
    else T=0;
    PC+=2;
}
```

```

TSTM(long i) /* TST.B #imm,@(R0,GBR) */
{
    long temp;

    temp=(long)Read_Byte(GBR+R[0]);
    temp&=(0x000000FF & (long)i);
    if (temp==0) T=1;
    else T=0;
    PC+=2;
}

```

### Example

TST	R0,R0	; Before execution	R0 = H'00000000
		; After execution	T = 1
TST	#H'80,R0	; Before execution	R0 = H'FFFFFF7F
		; After execution	T = 1
TST.B	#H'A5,@(R0,GBR)	; Before execution	(R0,GBR) = H'A5
		; After execution	T = 0

**10.102 XOR****eXclusive OR logical****Logical Instruction**

Exclusive  
Logical OR

Format	Summary of Operation	Instruction Code	Execution States	T Bit
XOR Rm,Rn	$Rn \wedge Rm \rightarrow Rn$	0010nnnnmmmm1010	1	—
XOR #imm,R0	$R0 \wedge imm \rightarrow R0$	11001010iiiiiii	1	—
XOR.B #imm,@(R0,GBR)	$(R0+GBR) \wedge imm \rightarrow (R0+GBR)$	11001110iiiiiii	4	—

**Description**

This instruction exclusively ORs the contents of general registers Rn and Rm, and stores the result in Rn.

This instruction can be used to exclusively OR register R0 contents with zero-extended 8-bit immediate data, or, in indexed GBR indirect addressing mode, to exclusively OR 8-bit memory with 8-bit immediate data.

**Operation**

```
XOR(long m, long n) /* XOR Rm,Rn */
{
    R[n]^=R[m];
    PC+=2;
}

XORI(long i) /* XOR #imm,R0 */
{
    R[0]^=(0x000000FF & (long)i);
    PC+=2;
}

XORM(long i) /* XOR.B #imm,@(R0,GBR) */
{
    int temp;

    temp=(long)Read_Byte(GBR+R[0]);
    temp^=(0x000000FF & (long)i);
}
```

```
    Write_Byte(GBR+R[0],temp);  
    PC+=2;  
}
```

### Example

```
XOR    R0,R1           ; Before execution R0 = H'AAAAAAAA, R1 = H'55555555  
                          ; After execution R1 = H'FFFFFFFF  
XOR    #H'F0,R0        ; Before execution R0 = H'FFFFFFFF  
                          ; After execution R0 = H'FFFFFF0F  
XOR.B  #H'A5,@(R0,GBR) ; Before execution (R0,GBR) = H'A5  
                          ; After execution (R0,GBR) = H'00
```

**10.103 XTRCT eXTRaCT**  
 Middle Extraction  
 from Linked Registers

**Data Transfer Instruction**

Format	Summary of Operation	Instruction Code	Execution States	T Bit
XTRCT Rm,Rn	Middle 32 bits of Rm:Rn → Rn	0010nnnnnnmmmm1101	1	—

**Description**

This instruction extracts the middle 32 bits from the 64-bit contents of linked general registers Rm and Rn, and stores the result in Rn.

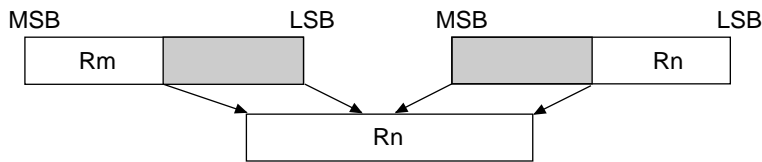

**Operation**

```
XTRCT(long m, long n) /* XTRCT Rm,Rn */
{
    unsigned long temp;

    temp=(R[m]<<16)&0xFFFF0000;
    R[n]=(R[n]>>16)&0x0000FFFF;
    R[n]|=temp;
    PC+=2;
}
```

**Example**

```
XTRCT R0,R1 ; Before execution R0 = H'01234567, R1 = H'89ABCDEF
; After execution R1 = H'456789AB
```

# Appendix A Address List

**Table A.1 Address List**

Module	Register	P4 Address	Area 7 Address* <sup>1</sup>	Size	Power-On Reset	Manual Reset	Sleep	Standby	Synchronization Clock
CCN	PTEH	H'FF00 0000	H'1F00 0000	32	Undefined	Undefined	Held	Held	Iclk
CCN	PTL	H'FF00 0004	H'1F00 0004	32	Undefined	Undefined	Held	Held	Iclk
CCN	TTB	H'FF00 0008	H'1F00 0008	32	Undefined	Undefined	Held	Held	Iclk
CCN	TEA	H'FF00 000C	H'1F00 000C	32	Undefined	Held	Held	Held	Iclk
CCN	MMUCR	H'FF00 0010	H'1F00 0010	32	H'0000 0000	H'0000 0000	Held	Held	Iclk
CCN	BASRA	H'FF00 0014	H'1F00 0014	8	Undefined	Held	Held	Held	Iclk
CCN	BASRB	H'FF00 0018	H'1F00 0018	8	Undefined	Held	Held	Held	Iclk
CCN	CCR	H'FF00 001C	H'1F00 001C	32	H'0000 0000	H'0000 0000	Held	Held	Iclk
CCN	TRA	H'FF00 0020	H'1F00 0020	32	Undefined	Undefined	Held	Held	Iclk
CCN	EXPEVT	H'FF00 0024	H'1F00 0024	32	H'0000 0000	H'0000 0020	Held	Held	Iclk
CCN	INTEVT	H'FF00 0028	H'1F00 0028	32	Undefined	Undefined	Held	Held	Iclk
CCN	PTEA	H'FF00 0034	H'1F00 0034	32	Undefined	Undefined	Held	Held	Iclk
CCN	QACR0	H'FF00 0038	H'1F00 0038	32	Undefined	Undefined	Held	Held	Iclk
CCN	QACR1	H'FF00 003C	H'1F00 003C	32	Undefined	Undefined	Held	Held	Iclk
<hr/>									
UBC	BARA	H'FF20 0000	H'1F20 0000	32	Undefined	Held	Held	Held	Iclk
UBC	BAMRA	H'FF20 0004	H'1F20 0004	8	Undefined	Held	Held	Held	Iclk
UBC	BBRA	H'FF20 0008	H'1F20 0008	16	H'0000	Held	Held	Held	Iclk
UBC	BARB	H'FF20 000C	H'1F20 000C	32	Undefined	Held	Held	Held	Iclk
UBC	BAMRB	H'FF20 0010	H'1F20 0010	8	Undefined	Held	Held	Held	Iclk
UBC	BBRB	H'FF20 0014	H'1F20 0014	16	H'0000	Held	Held	Held	Iclk
UBC	BDRB	H'FF20 0018	H'1F20 0018	32	Undefined	Held	Held	Held	Iclk
UBC	BDMRB	H'FF20 001C	H'1F20 001C	32	Undefined	Held	Held	Held	Iclk
UBC	BRCR	H'FF20 0020	H'1F20 0020	16	H'0000* <sup>2</sup>	Held	Held	Held	Iclk
<hr/>									
BSC	BCR1	H'FF80 0000	H'1F80 0000	32	H'0000 0000* <sup>2</sup>	Held	Held	Held	Bclk
BSC	BCR2	H'FF80 0004	H'1F80 0004	16	H'3FFC* <sup>2</sup>	Held	Held	Held	Bclk
BSC	WCR1	H'FF80 0008	H'1F80 0008	32	H'7777 7777	Held	Held	Held	Bclk
BSC	WCR2	H'FF80 000C	H'1F80 000C	32	H'FFFE EFFF	Held	Held	Held	Bclk
BSC	WCR3	H'FF80 0010	H'1F80 0010	32	H'0777 7777	Held	Held	Held	Bclk

**Table A.1 Address List (cont)**

Module	Register	P4 Address	Area 7 Address*1	Size	Power-On Reset	Manual Reset	Sleep	Standby	Synchronization Clock
BSC	MCR	H'FF80 0014	H'1F80 0014	32	H'0000 0000	Held	Held	Held	Bclk
BSC	PCR	H'FF80 0018	H'1F80 0018	16	H'0000	Held	Held	Held	Bclk
BSC	RTCSR	H'FF80 001C	H'1F80 001C	16	H'0000	Held	Held	Held	Bclk
BSC	RTCNT	H'FF80 0020	H'1F80 0020	16	H'0000	Held	Held	Held	Bclk
BSC	RTCOR	H'FF80 0024	H'1F80 0024	16	H'0000	Held	Held	Held	Bclk
BSC	RFCR	H'FF80 0028	H'1F80 0028	16	H'0000	Held	Held	Held	Bclk
BSC	PCTRA	H'FF80 002C	H'1F80 002C	32	H'0000 0000	Held	Held	Held	Bclk
BSC	PDTRA	H'FF80 0030	H'1F80 0030	16	Undefined	Held	Held	Held	Bclk
BSC	PCTRB	H'FF80 0040	H'1F80 0040	32	H'0000 0000	Held	Held	Held	Bclk
BSC	PDTRB	H'FF80 0044	H'1F80 0044	16	Undefined	Held	Held	Held	Bclk
BSC	GPIOIC	H'FF80 0048	H'1F80 0048	16	H'0000 0000	Held	Held	Held	Bclk
BSC	SDMR2	H'FF90 xxxx	H'1F90 xxxx	8	Write-only				Bclk
BSC	SDMR3	H'FF94 xxxx	H'1F94 xxxx	8					Bclk
DMAC	SAR0	H'FFA0 0000	H'1FA0 0000	32	Undefined	Undefined	Held	Held	Bclk
DMAC	DAR0	H'FFA0 0004	H'1FA0 0004	32	Undefined	Undefined	Held	Held	Bclk
DMAC	DMATCR0	H'FFA0 0008	H'1FA0 0008	32	Undefined	Undefined	Held	Held	Bclk
DMAC	CHCR0	H'FFA0 000C	H'1FA0 000C	32	H'0000 0000	H'0000 0000	Held	Held	Bclk
DMAC	SAR1	H'FFA0 0010	H'1FA0 0010	32	Undefined	Undefined	Held	Held	Bclk
DMAC	DAR1	H'FFA0 0014	H'1FA0 0014	32	Undefined	Undefined	Held	Held	Bclk
DMAC	DMATCR1	H'FFA0 0018	H'1FA0 0018	32	Undefined	Undefined	Held	Held	Bclk
DMAC	CHCR1	H'FFA0 001C	H'1FA0 001C	32	H'0000 0000	H'0000 0000	Held	Held	Bclk
DMAC	SAR2	H'FFA0 0020	H'1FA0 0020	32	Undefined	Undefined	Held	Held	Bclk
DMAC	DAR2	H'FFA0 0024	H'1FA0 0024	32	Undefined	Undefined	Held	Held	Bclk
DMAC	DMATCR2	H'FFA0 0028	H'1FA0 0028	32	Undefined	Undefined	Held	Held	Bclk
DMAC	CHCR2	H'FFA0 002C	H'1FA0 002C	32	H'0000 0000	H'0000 0000	Held	Held	Bclk
DMAC	SAR3	H'FFA0 0030	H'1FA0 0030	32	Undefined	Undefined	Held	Held	Bclk
DMAC	DAR3	H'FFA0 0034	H'1FA0 0034	32	Undefined	Undefined	Held	Held	Bclk
DMAC	DMATCR3	H'FFA0 0038	H'1FA0 0038	32	Undefined	Undefined	Held	Held	Bclk
DMAC	CHCR3	H'FFA0 003C	H'1FA0 003C	32	H'0000 0000	H'0000 0000	Held	Held	Bclk
DMAC	DMAOR	H'FFA0 0040	H'1FA0 0040	32	H'0000 0000	H'0000 0000	Held	Held	Bclk

**Table A.1 Address List (cont)**

Module	Register	P4 Address	Area 7 Address* <sup>1</sup>	Size	Power-On Reset	Manual Reset	Sleep	Standby	Synchronization Clock
CPG	FRQCR	H'FFC0 0000	H'1FC0 0000	16	* <sup>2</sup>	Held	Held	Held	Pclk
CPG	STBCR	H'FFC0 0004	H'1FC0 0004	8	H'00	Held	Held	Held	Pclk
CPG	WTCNT	H'FFC0 0008	H'1FC0 0008	8/16* <sup>3</sup>	H'00	Held	Held	Held	Pclk
CPG	WTCSR	H'FFC0 000C	H'1FC0 000C	8/16* <sup>3</sup>	H'00	Held	Held	Held	Pclk
CPG	STBCR2	H'FFC0 0010	H'1FC0 0010	8	H'00	Held	Held	Held	Pclk
<hr/>									
RTC	R64CNT	H'FFC8 0000	H'1FC8 0000	8	Held	Held	Held	Held	Pclk
RTC	RSECCNT	H'FFC8 0004	H'1FC8 0004	8	Held	Held	Held	Held	Pclk
RTC	RMINCNT	H'FFC8 0008	H'1FC8 0008	8	Held	Held	Held	Held	Pclk
RTC	RHRCNT	H'FFC8 000C	H'1FC8 000C	8	Held	Held	Held	Held	Pclk
RTC	RWKCNT	H'FFC8 0010	H'1FC8 0010	8	Held	Held	Held	Held	Pclk
RTC	RDAYCNT	H'FFC8 0014	H'1FC8 0014	8	Held	Held	Held	Held	Pclk
RTC	RMONCNT	H'FFC8 0018	H'1FC8 0018	8	Held	Held	Held	Held	Pclk
RTC	RYRCNT	H'FFC8 001C	H'1FC8 001C	16	Held	Held	Held	Held	Pclk
RTC	RSECAR	H'FFC8 0020	H'1FC8 0020	8	Held* <sup>2</sup>	Held	Held	Held	Pclk
RTC	RMINAR	H'FFC8 0024	H'1FC8 0024	8	Held* <sup>2</sup>	Held	Held	Held	Pclk
RTC	RHRAR	H'FFC8 0028	H'1FC8 0028	8	Held* <sup>2</sup>	Held	Held	Held	Pclk
RTC	RWKAR	H'FFC8 002C	H'1FC8 002C	8	Held* <sup>2</sup>	Held	Held	Held	Pclk
RTC	RDAYAR	H'FFC8 0030	H'1FC8 0030	8	Held* <sup>2</sup>	Held	Held	Held	Pclk
RTC	RMONAR	H'FFC8 0034	H'1FC8 0034	8	Held* <sup>2</sup>	Held	Held	Held	Pclk
RTC	RCR1	H'FFC8 0038	H'1FC8 0038	8	H'00* <sup>2</sup>	H'00* <sup>2</sup>	Held	Held	Pclk
RTC	RCR2	H'FFC8 003C	H'1FC8 003C	8	H'09* <sup>2</sup>	H'00* <sup>2</sup>	Held	Held	Pclk
<hr/>									
INTC	ICR	H'FFD0 0000	H'1FD0 0000	16	H'0000* <sup>2</sup>	H'0000* <sup>2</sup>	Held	Held	Pclk
INTC	IPRA	H'FFD0 0004	H'1FD0 0004	16	H'0000	H'0000	Held	Held	Pclk
INTC	IPRB	H'FFD0 0008	H'1FD0 0008	16	H'0000	H'0000	Held	Held	Pclk
INTC	IPRC	H'FFD0 000C	H'1FD0 000C	16	H'0000	H'0000	Held	Held	Pclk
<hr/>									
TMU	TOCR	H'FFD8 0000	H'1FD8 0000	8	H'00	H'00	Held	Held	Pclk
TMU	TSTR	H'FFD8 0004	H'1FD8 0004	8	H'00	H'00	Held	H'00* <sup>2</sup>	Pclk
TMU	TCOR0	H'FFD8 0008	H'1FD8 0008	32	H'FFFF FFFF	H'FFFF FFFF	Held	Held	Pclk
TMU	TCNT0	H'FFD8 000C	H'1FD8 000C	32	H'FFFF FFFF	H'FFFF FFFF	Held	Held	Pclk
TMU	TCR0	H'FFD8 0010	H'1FD8 0010	16	H'0000	H'0000	Held	Held	Pclk



**Table A.1 Address List (cont)**

Module	Register	P4 Address	Area 7 Address* <sup>1</sup>	Size	Power-On Reset	Manual Reset	Sleep	Standby	Synchronization Clock
TMU	TCOR1	H'FFD8 0014	H'1FD8 0014	32	H'FFFF FFFF	H'FFFF FFFF	Held	Held	Pclk
TMU	TCNT1	H'FFD8 0018	H'1FD8 0018	32	H'FFFF FFFF	H'FFFF FFFF	Held	Held	Pclk
TMU	TCR1	H'FFD8 001C	H'1FD8 001C	16	H'0000	H'0000	Held	Held	Pclk
TMU	TCOR2	H'FFD8 0020	H'1FD8 0020	32	H'FFFF FFFF	H'FFFF FFFF	Held	Held	Pclk
TMU	TCNT2	H'FFD8 0024	H'1FD8 0024	32	H'FFFF FFFF	H'FFFF FFFF	Held	Held	Pclk
TMU	TCR2	H'FFD8 0028	H'1FD8 0028	16	H'0000	H'0000	Held	Held	Pclk
TMU	TCPR2	H'FFD8 002C	H'1FD8 002C	32	Held	Held	Held	Held	Pclk
SCI	SCSMR1	H'FFE0 0000	H'1FE0 0000	8	H'00	H'00	Held	H'00	Pclk
SCI	SCBRR1	H'FFE0 0004	H'1FE0 0004	8	H'FF	H'FF	Held	H'FF	Pclk
SCI	SCSCR1	H'FFE0 0008	H'1FE0 0008	8	H'00	H'00	Held	H'00	Pclk
SCI	SCTDR1	H'FFE0 000C	H'1FE0 000C	8	H'FF	H'FF	Held	H'FF	Pclk
SCI	SCSSR1	H'FFE0 0010	H'1FE0 0010	8	H'84	H'84	Held	H'84	Pclk
SCI	SCRDR1	H'FFE0 0014	H'1FE0 0014	8	H'00	H'00	Held	H'00	Pclk
SCI	SCSCMR1	H'FFE0 0018	H'1FE0 0018	8	H'00	H'00	Held	H'00	Pclk
SCI	SCSPTR1	H'FFE0 001C	H'1FE0 001C	8	H'00* <sup>2</sup>	H'00* <sup>2</sup>	Held	H'00* <sup>2</sup>	Pclk
SCIF	SCSMR2	H'FFE8 0000	H'1FE8 0000	16	H'0000	H'0000	Held	Held	Pclk
SCIF	SCBRR2	H'FFE8 0004	H'1FE8 0004	8	H'FF	H'FF	Held	Held	Pclk
SCIF	SCSCR2	H'FFE8 0008	H'1FE8 0008	16	H'0000	H'0000	Held	Held	Pclk
SCIF	SCFTDR2	H'FFE8 000C	H'1FE8 000C	8	Undefined	Undefined	Held	Held	Pclk
SCIF	SCFSR2	H'FFE8 0010	H'1FE8 0010	16	H'0060	H'0060	Held	Held	Pclk
SCIF	SCFRDR2	H'FFE8 0014	H'1FE8 0014	8	Undefined	Undefined	Held	Held	Pclk
SCIF	SCFCR2	H'FFE8 0018	H'1FE8 0018	16	H'0000	H'0000	Held	Held	Pclk
SCIF	SCFDR2	H'FFE8 001C	H'1FE8 001C	16	H'0000	H'0000	Held	Held	Pclk
SCIF	SCSPTR2	H'FFE8 0020	H'1FE8 0020	16	H'0000* <sup>2</sup>	H'0000* <sup>2</sup>	Held	Held	Pclk
SCIF	SCLSR2	H'FFE8 0024	H'1FE8 0024	16	H'0000	H'0000	Held	Held	Pclk
Hitachi-UDI	SDIR	H'FFF0 0000	H'1FF0 0000	16	H'FFFF* <sup>2</sup>	Held	Held	Held	Pclk
Hitachi-UDI	SDDR	H'FFF0 0008	H'1FF0 0008	32	Held	Held	Held	Held	Pclk

Notes: 1. With control registers, the above addresses in the physical page number field can be accessed by means of a TLB setting. When these addresses are referenced directly without using the TLB, operations are limited.

2. Includes undefined bits. See the descriptions of the individual modules.
3. Use word-size access when writing. Perform the write with the upper byte set to H'5A or H'A5, respectively. Byte- and longword-size writes cannot be used.  
Use byte-size access when reading.

## Appendix B Instruction Prefetch Side Effects

The SH4 is provided with an internal buffer for holding pre-read instructions, and always performs pre-reading. Therefore, program code must not be located in the last 20-byte area of any memory space. If program code is located in these areas, the memory area will be exceeded and a bus access for instruction pre-reading may be initiated. A case in which this is a problem is shown below.

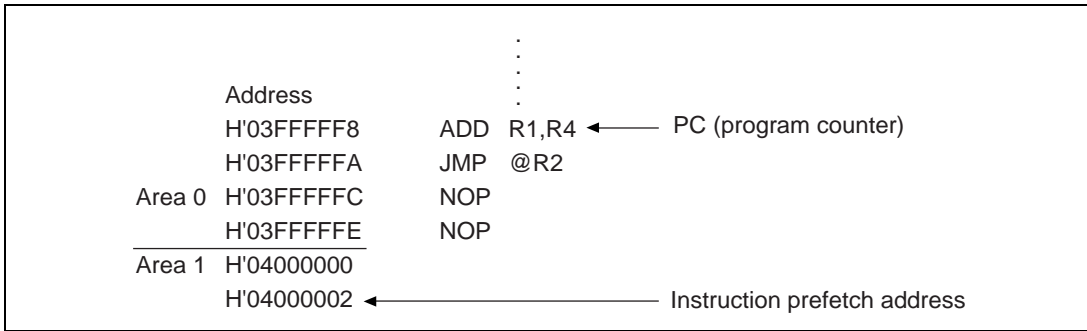

**Figure B.1 Instruction Prefetch**

Figure B.1 presupposes a case in which the instruction (ADD) indicated by the program counter (PC) and the address H'04000002 instruction prefetch are executed simultaneously. It is also assumed that the program branches to an area outside area 1 after executing the following JMP instruction and delay slot instruction.

In this case, the program flow is unpredictable, and a bus access (instruction prefetch) to area 1 may be initiated.

### Instruction Prefetch Side Effects

1. It is possible that an external bus access caused by an instruction prefetch may result in misoperation of an external device, such as a FIFO, connected to the area concerned.
2. If there is no device to reply to an external bus request caused by an instruction prefetch, hangup will occur.

### Remedies

1. These illegal instruction fetches can be avoided by using the MMU.
2. The problem can be avoided by not locating program code in the last 20 bytes of any area.

---

## **SH7750 Programming Manual**

Publication Date: 1st Edition, August 1998

3rd Edition, September 1999

Published by: Electronic Devices Sales & Marketing Group  
Semiconductor & Integrated Circuits  
Hitachi, Ltd.

Edited by: Technical Documentation Group  
UL Media Co., Ltd.

Copyright © Hitachi, Ltd., 1998. All rights reserved. Printed in Japan.